

# QST

October, 1937  
25 cents

devoted entirely to

# amateur radio

*In this Issue—*

**A Stage  
Switching  
Exciter**

**Automatic  
Modulation  
Control**

**Radio-Control  
for Models**



# COLLINS 18 J

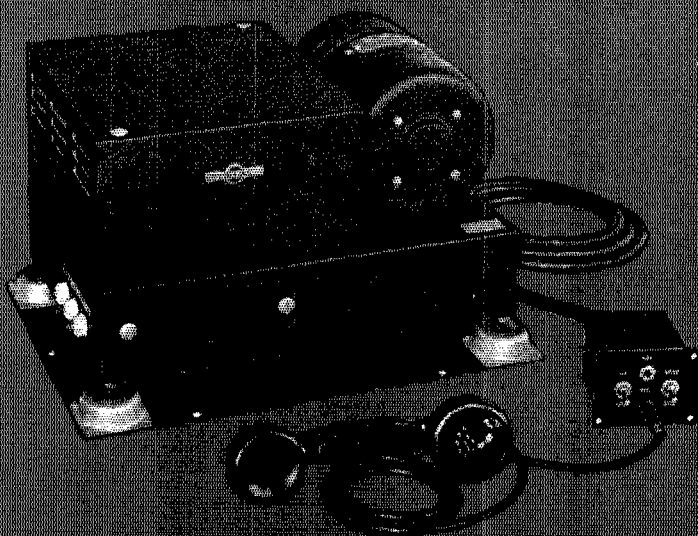

**C**OLLINS 18J TRANSMITTER is a 10 watt crystal controlled u.h.f. set designed primarily for police car use, but also of interest to amateurs desiring a high quality, reliable 56 mc. mobile transmitter.

The 18J features uni-chassis construction which simplifies installation. Tuning controls are protected by cover plates. Air craft type shock mountings minimize vibration and great care has been taken in mechanical design to afford dependability under hard service. Tubes used are: 1-C100D, 4-807's, and 2-6L6's. Plug-in coils may be had for frequencies between 10 mc. and 60 mc. Dimensions: 17" by 11" by 12½"; Weight: 45 pounds. Six or twelve volt batteries may be used. A variety of remote control accessories is available.

The 18J is typical of a series including all types of mobile transmitters. Special designs can be built for individual needs.

**COLLINS RADIO COMPANY**  
C E D A R   R A P I D S   I O W A  
N E W Y O R K , N . Y : 1 1 W E S T 4 2 S T R E E T

# the hallicrafters

AMERICA'S MOST COMPLETE LINE OF COMMUNICATIONS RECEIVERS!



There's a precision-engineered Hallicrafters Receiver for every amateur or short wave listener, whether he's just a beginner on the air or an "Old Timer" who is playing with 5 meters, and whatever the state of his purse!

All Hallicrafters Receivers available on liberal time payments through your dealer.

Write for illustrated booklet fully describing the Hallicrafters Line.

Hallicrafters Receivers are licensed by RCA and Hazeltine.

AMERICA'S LEADING MANUFACTURER OF COMMUNICATIONS RECEIVERS

# the hallicrafters inc.

2611 INDIANA AVENUE, CHICAGO, U. S. A. • CABLE ADDRESS "Hallicraft" CHICAGO

Say You Saw It in QST — It Identifies You and Helps QST

THE SUPER SKY RIDER

# Order Your NEW 1938 SUPER SKY RIDER Now!

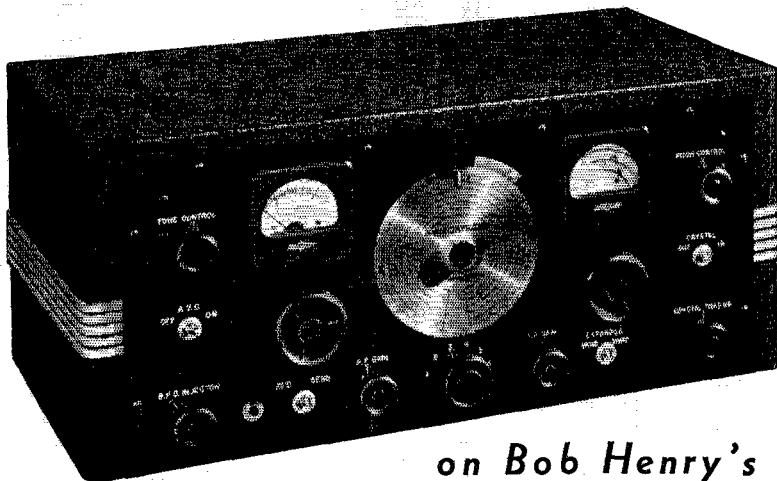

## on Bob Henry's LIBERAL TIME PAYMENT PLAN

Why wait? Enjoy the superior performance of this sensational new SUPER SKYRIDER while you pay for it on my easy credit terms, arranged to suit your convenience, with a minimum carrying charge. The entire transaction will be strictly between us. I finance my own paper, and for this reason can make you exceptionally liberal terms, and can arrange terms to suit you with payments to be made just as you wish.

### 10-DAY FREE TRIAL

Try out any new Hallicrafters' receiver for 10 days without cost or obligation. If you will send me your order with a \$5.00 deposit, your receiver will be shipped immediately by express. Then leave a deposit with your express agent while you try out the receiver. If returned, you get your deposit back.

### SATISFACTION GUARANTEED

Your dealings with the Henry Radio Shop are all handled by Bob Henry, W9ARA, personally, an M. I. T. graduate E.E., and an active amateur for 12 years. I try to give better and quicker service, 24 hours a day, 7 days a week. Write, wire, or phone; your order or inquiry will get my personal, prompt attention.

*Robert Henry*  
W9ARA

### COMPARE BOB HENRY'S TERMS WITH OTHERS

Model of Receiver	Cash Price	Down Payment	12 Monthly Payments
Sky Buddy.....	\$29.50	\$5.90	\$2.20
Sky Chief.....	44.50	8.90	3.27
Sky Challenger.....	69.50	13.90	4.15
Sky Challenger & speaker.....	79.00	15.80	5.70
Sky Challenger & Xtal.....	79.50	15.90	5.74
Sky Challenger & Xtal & speaker.....	89.00	17.80	6.40
Super Skyrider.....	99.00	19.80	7.11
Super Skyrider & speaker.....	111.00	22.20	7.96
Super Skyrider & Xtal.....	111.00	22.20	7.96
Super Skyrider & Xtal & speaker.....	123.00	24.60	8.81
Ultra Skyrider.....	99.50	19.90	7.15

## HENRY RADIO SHOP

211-215 North Main St.

Butler, Missouri

the hallicrafters inc.

THE SKY BUDDY THE SKY CHIEF THE SKY CHALLENGER THE SKY RIDER THE ULTRA SKY RIDER

THE SKY RIDER COMMERCIAL THE SKY CHALLENGER



# QST

devoted entirely to

# AMATEUR RADIO

PUBLISHED, MONTHLY, AS ITS OFFICIAL ORGAN, BY THE AMERICAN RADIO RELAY LEAGUE, INC., AT WEST HARTFORD, CONN., U. S. A.; OFFICIAL ORGAN OF THE INTERNATIONAL AMATEUR RADIO UNION

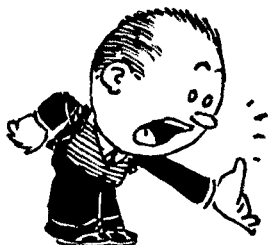

## OCTOBER

## 1937

### Volume XXI

### Number 10



Kenneth B. Warner (Secretary, A.R.R.L.), *Editor-in-Chief and Business Manager*; Ross A. Hull, *Associate Editor*; James J. Lamb, *Technical Editor*; George Grammer, *Assistant Technical Editor*; Clark C. Rodimon, *Managing Editor*; David H. Houghton, *Circulation Manager*; Ralph T. Beaudin, *Assistant Circulation Manager*; F. Cheyney Beckley, *Advertising Manager*; Charles Brunelle, *Assistant Advertising Manager*.

*Editorial and Advertising Offices*

38 La Salle Road  
West Hartford, Connecticut

Subscription rate in United States and Possessions and Canada, \$2.50 per year, postpaid; all other countries, \$3.00 per year, postpaid. Single copies, 25 cents. Foreign remittances should be by international postal or express money order or bank draft negotiable in the U. S. and for an equivalent amount in U. S. funds.

Entered as second-class matter May 29, 1919, at the post office at Hartford, Connecticut, under the Act of March 3, 1879. Acceptance for mailing at special rate of postage provided for in section 1103, Act of October 3, 1917, authorized September 9, 1922. Additional entry at Concord, N. H., authorized February 21, 1929, under the Act of February 28, 1925.

Additional second-class entries to cover sectional editions authorized March 20, 1935. Copyright 1937 by the American Radio Relay League, Inc. Title registered at United States Patent Office.

## The Contents

Editorials . . . . .	7
Radio Course Starts . . . . .	8
Radio Control of Model Aircraft <i>Ross A. Hull and R. B. Bourne, W1ANA</i>	9
With the European Amateurs on the Bucharest C.C.I.R. Trip . . . <i>J. J. Lamb, W1AL and J. C. Stadler, VE2AP</i>	14
A Semi-Universal Exciter with Stage Switching <i>George Grammer</i>	17
What the League Is Doing . . . . .	20
Modernizing the Simple Regenerative Receiver <i>Vernon Chambers, W1JEQ</i>	22
Results, 1937 DX Competition . . . <i>E. L. Battey, W1UE</i>	24
Concentrated Directional Antennas for Transmission and Reception . . . . .	27
More on PITS . . . . .	30
Negative Peak Automatic Modulation Control for Plate- Modulated Transmitters . . . . .	31
Southwestern Division Convention . . . . .	35
A Versatile Transmitter . . . <i>Walter J. Stiles, Jr., W8DPY</i>	36
A.R.R.L. QSL Bureau . . . . .	37
Schedules for WWV . . . . .	37
How Would You Do It? . . . . .	38
Amateur Radio Stations . . . . . <i>W2CSY, W8QAN</i>	39
The Cover . . . . .	40
Massachusetts State Convention . . . . .	40
Silent Keys . . . . .	40
Hints and Kinks for the Experimenter . . . . .	41
I.A.R.U. News . . . . .	43
Operating News . . . . .	45
Correspondence Department . . . . .	53
Standard Frequency Transmissions . . . . .	58
Hamads . . . . .	123
QST's Index of Advertisers . . . . .	126

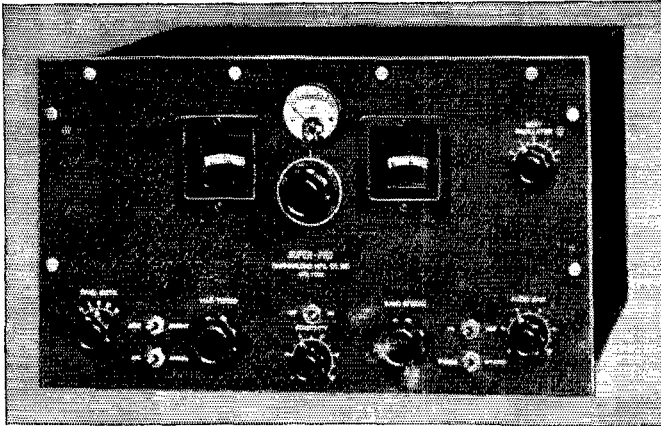

★  
STANDARD  
"SUPER-PRO"  
IN METAL  
CABINET

## A *Quality* RECEIVER FOR SUPERIOR *Results...*

WHEREVER quality receiving equipment is imperative for exacting and diversified work, you will find the new "Super-Pro" receivers in constant use. Ruggedly built, yet possessing a "Bureau of Standards" accuracy, the "Super-Pro" affords those superior, reliable results that the professional, engineer, or amateur must have to carry out their important schedules. All "Super-Pro" models — crystal or standard, table model or rack for 7½ to 240 or 15 to 560 meters — have two stages of R.F. on all five bands affording a sensitivity of 0.85 micro-volt and image rejection ratios from 150 to 1 at 28 mc. to 65,000 to 1 at 2 mc. Other "Super-Pro" features are calibrated bandwidth (3 to 16 kc.), beat oscillator, audio, and sensitivity controls; noiseless cam-switch; direct tuning, accurate to within ½%; separate electrical band spread control; high fidelity; C.W.-Mod., Standby, A.V. C-Man., Speaker-Phone switches; relay strip; 8 metal and 8 glass tubes, etc.

To complete that quality installation, install the new "Super-Pro" receiver. See the "Super-Pro" at your dealer today. Further details will be gladly mailed upon request. Just send in the coupon below!

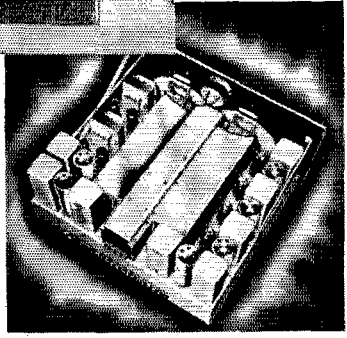

★ STANDARD "SUPER-PRO"  
RECEIVER CHASSIS

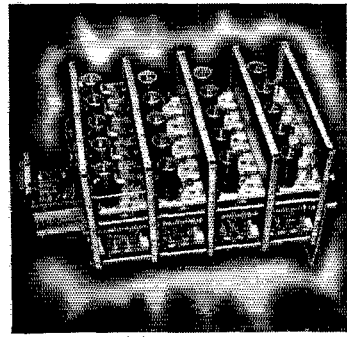

★ SELF CONTAINED "SUPER-PRO"  
TUNING UNIT

MAIL  
THIS  
COUPON!

HAMMARLUND MFG. CO., INC.  
424-438 W. 33 St., N. Y. City  
 Please send me "Super-Pro" bulletin.  
Name.....  
Address.....  
City.....State.....Q-10



# HAMMARLUND

## Section Communications Managers of the A.R.R.L. Communications Department

All appointments in the League's field organization are made by the proper S.C.M., elected by members in each Section listed. Mail your S.C.M. (on the 16th of each month) a postal covering your radio activities for the previous 30 days. Tell him your DX, plans for experimenting, results in phone and traffic. He is interested, whether you are an A.R.R.L. member or get your QST at the newstands; he wants a report from every active ham. If interested and qualified for O.R.S., O.P.S. or other appointments he can tell you about them, too.

Eastern Pennsylvania Maryland-Delaware-District of Columbia Southern New Jersey Western New York Western Pennsylvania	W3QP W3BAK W3BEI W8DSS W8OFO	<b>ATLANTIC DIVISION</b> John Buck Morgan Edgar L. Hudson W. W. Filson Charles Smith Kendall Speer, Jr.	8527 Germantown Ave. R. 4, Box 1 247 E. Walnut Ave. 310 E. Walnut St.	Chestnut Hill, Philadelphia Laurel, Delaware Aubudon Onida Lower
Illinois Indiana Kentucky Michigan Ohio Wisconsin	W9KJY W9QG W9AUH W8DPE W8AQ W9ATO	<b>CENTRAL DIVISION</b> L. John Huntoon Noble Burkhart G. W. Mossbarger Harold C. Bird E. H. Gibbs E. A. Cary	327 Brandon Ave. R. 4, Box 1 Box 177 R.F.D. 3 405 Broad St. 3922 No. 19th Pl.	Glen Elyn Indianapolis Camp Taylor Pontiac Wadsworth Milwaukee
North Dakota South Dakota Northern Minnesota Southern Minnesota	W9RZA W9SEB W9JGZ W9DCM	<b>DAKOTA DIVISION</b> Ernest Bloch Andrew J. Kjar Edwin L. Wicklund Webster F. Soules	Box 202 221 West Prospect Ave. R.F.D. 3 3549 30th Ave., So.	Thompson Pierre Kenington Minneapolis
Arkansas Louisiana Mississippi Tennessee	W5ABI W5DKR W5CWO W4DEP	<b>DELTA DIVISION</b> H. E. Velte Eugene H. Treadaway J. H. Weems, Jr. B. G. Lowrey Smith	4415 West 12th St. 2749 Myrtle St. P. O. Box 244 673 Hillcrest St.	Little Rock New Orleans State College Memphis
Eastern New York N. Y. C. & Long Island Northern New Jersey	W2LU W2AZV W2GMN	<b>HUDSON DIVISION</b> Robert E. Haight E. L. Baumach Fred C. Read	511 South Holmes St. 102 Central Ave. 1014 North Ave.	Scotia Massapequa, L. I. Elizabeth
Iowa Kansas Missouri Nebraska	W9NNM W9PB W9CJR W9FAM	<b>MIDWEST DIVISION</b> Owen Williams Harry E. Legler J. Dewey Mills Samuels C. Wallace	108 No. Johnson St. 304 Miami St. Box 205 Green St.	Iowa City Hiawatha Mount Vernon Clarks
Connecticut Maine Eastern Massachusetts Western Massachusetts New Hampshire Rhode Island Vermont	W1CTI W1FBJ W1IWC W1JAH W1BFT W1HRC W1GNF	<b>NEW ENGLAND DIVISION</b> Frederick Eils, Jr. Winfield A. Ramsdell Sam Gross William J. Barrett Carl B. Evans Clayton C. Gordon Alvin H. Battison	19 Merrill Rd. 1188 Washington Ave. Pleasant St. 239 Columbia St. 301 No. State St. 702 Washington Ave. 1 Central St.	Norwalk Portland Marshfield Hills Adams Concord Providence Windsor
Alaska Idaho Montana Oregon Washington	K7PO W7EMT W7CRH W7AJV W7WY	<b>NORTHWESTERN DIVISION</b> Richard J. Fox Carl Eichelberger Russell U. Richmond Eugene E. Lovejoy Robert H. Votaw	Box 301 2810 North 26th St. 5013 N. E. Clackamas Route 1, Box 398	Ketchikan Boise Somers Portland Vancouver
Hawaii Nevada Santa Clara Valley East Bay San Francisco Sacramento Valley Philippines San Joaquin Valley	K6AIA W6BIC W6FBW W6JTV W6SGZ W6GZY K6AGR W6LPE	<b>PACIFIC DIVISION</b> Otis Hill Edward W. Heim Elbert Amarantes Harold J. Burchfield Alan D. Whittaker, Jr. J. L. C. Buckenham George L. Rickard Angelo V. Astone	Box 952 509 Claremont St. 454 Washington St. 2240 106th Ave. 79 Filnor Ave. 2931-24th St. Box 849 729 Safford	Hilo Reno San Jose Oakland Mill Valley Sacramento Manila Fresno
North Carolina South Carolina Virginia West Virginia	W4OG W4BQE W3IWA W8HD	<b>ROANOKE DIVISION</b> H. S. Carter Ted Ferguson Charles M. Wauff, Jr. C. S. Hoffmann, Jr.	P. O. Box 111 1213 College St. 2914 Monument Ave. 47 Lynwood Ave.	Winston-Salem Columbia Richmond Wheeling
Colorado Utah-Wyoming	W9FA W7COH	<b>ROCKY MOUNTAIN DIVISION</b> Glen Glascock Townsend J. Rigby	2164 So. Corona St.	Denver Midwest, Wyoming
Alabama Eastern Florida* Western Florida Georgia-Cuba-Isle-of-Pines- Porto Rico-Virgin Islands	W4DGS W4DVO W4BSJ *W4PM	<b>SOUTHEASTERN DIVISION</b> James F. Thompson L. A. Connolly Ellis R. Curry Charles W. Davis	102 Narrow Lane Rd. 712 S. Edison Ave. Box 425 2136 N E Boulevard Dr	Montgomery Tampa Madison Atlanta, Ga.
Los Angeles Arizona San Diego	W6GXM W6KFC W6EOP	<b>SOUTHWESTERN DIVISION</b> Don M. Draper Victor C. Clark Harry A. Ambler	4421 West 63 St. 747 E. Polk St. 731 York St.	Los Angeles Phoenix Mission Beach
Northern Texas Oklahoma Southern Texas New Mexico	W5DXA W5CEZ W5BDI W5CGJ	<b>WEST GULF DIVISION</b> Lee Hughes Carter L. Simpson Ammon O. Young Joseph M. Eldodt	125 N. Main St. 2010 So. 4th St. 4803 Eli St.	Childress Ponca City Houston Chamita
Maritime	VE1DQ	<b>MARITIME DIVISION</b> A. M. Crowell	69 Dublin St.	Halifax, N. S.
Ontario	VE3SG	<b>ONTARIO DIVISION</b> Fred H. B. Saxon	302 Lee Ave.	Toronto, Ont.
Quebec	VE2EE	<b>QUEBEC DIVISION</b> Stan Comach	780 Brault Ave.	Verdun, P. Q.
Alberta British Columbia	VE4LX VE5EP	<b>VANALTA DIVISION</b> Alfred D. Kettenbach D. R. Vaughan-Smith	1221 Burnaby St.	Rockyford Vancouver
Manitoba Saskatchewan	VE4BG VE4EL	<b>PRAIRIE DIVISION</b> A. J. R. Simpson Wilfred Skaife	635 Garfield St. 2040 McFavish St.	Winnipeg Regina

\* Officials appointed to act until the membership of the Section choose permanent S.C.M.'s by nomination and election.

# The American Radio Relay League



## DIRECTORS

<i>President</i>	
EUGENE C. WOODRUFF	W8CMP 234 W. Fairmount Ave., State College, Pa.
<i>Vice-President</i>	
GEORGE W. BAILEY	W1KH 74 Webster Road, Weston, Mass.
<i>Canadian General Manager</i>	
ALEX REID	VE2BE 169 Logan Ave., St. Lambert, P. Q.
<i>Atlantic Division</i>	
WALTER BRADLEY MARTIN	W3QV Box 612, Roslyn, Pa.
<i>Central Division</i>	
R. H. G. MATHEWS	W9ZN 100 East Ohio St., Chicago
<i>Dakota Division</i>	
CARL L. JABS	W9BVH 1822 James St., St. Paul, Minn.
<i>Delta Division</i>	
E. RAY ARLEDGE	W5SI P. O. Box 286, Pine Bluff, Ark.
<i>Hudson Division</i>	
KENNETH T. HILL	W2AHC 115 Willow St., Douglaston, L. I., N. Y.
<i>Midwest Division</i>	
FLOYD E. NORWINE, JR.	W9EFC 120 South Fourth St., St. Louis, Mo.
<i>New England Division</i>	
PERCY C. NOBLE	W1BVR 37 Broad St., Westfield, Mass.
<i>Northwestern Division</i>	
RALPH J. GIBBONS	W7KV c/o United Air Lines, Pendleton, Ore.
<i>Pacific Division</i>	
S. G. CULVER	W6AN 2962 Russell St., Berkeley, Calif.
<i>Roanoke Division</i>	
H. L. CAVENESS	W4DW State College Station, Raleigh, N. C.
<i>Rocky Mountain Division</i>	
EDWARD C. STOCKMAN	W9ESA 618 So. Williams St., Denver
<i>Southeastern Division</i>	
BENNETT R. ADAMS, JR.	W4APU 1512 Grove Place, Homewood, Ala.
<i>Southwestern Division</i>	
CHARLES E. BLALACK	W6GG 443 Main St., El Centro, Calif.
<i>West Gulf Division</i>	
WAYLAND M. GROVES	W5NW % Humble Pipe Line, Talco, Texas

• **T**HE AMERICAN RADIO RELAY LEAGUE, INC., is a non-commercial association of radio amateurs, bonded for the promotion of interest in amateur radio communication and experimentation, for the relaying of messages by radio, for the advancement of the radio art and of the public welfare, for the representation of the radio amateur in legislative matters, and for the maintenance of fraternalism and a high standard of conduct.

It is an incorporated association without capital stock, chartered under the laws of Connecticut. Its affairs are governed by a Board of Directors, elected every two years by the general membership. The officers are elected or appointed by the Directors. The League is non-commercial and no one commercially engaged in the manufacture, sale or rental of radio apparatus is eligible to membership on its board.

"Of, by and for the amateur," it numbers within its ranks practically every worth-while amateur in the nation and has a history of glorious achievement as the standard-bearer in amateur affairs.

Inquiries regarding membership are solicited. A bona fide interest in amateur radio is the only essential qualification; ownership of a transmitting station and knowledge of the code are not prerequisite. Correspondence should be addressed to the Secretary.

HIRAM PERCY MAXIM, FIRST PRESIDENT

## OFFICERS

<i>President</i>	EUGENE C. WOODRUFF, W8CMP State College, Pa.
<i>Vice-President</i>	GEORGE W. BAILEY, W1KH Weston, Mass.
<i>Secretary</i>	KENNETH B. WARNER, W1EH West Hartford, Connecticut
<i>Treasurer</i>	ARTHUR A. HEBERT, W1ES West Hartford, Connecticut
<i>Communications Mgr.</i>	F. EDWARD HANDY, W1BDI West Hartford, Connecticut
◆	
<i>General Counsel</i>	PAUL M. SEGAL 1010 Shoreham Building, Washington, D. C.
◆	

Address all general correspondence to the administrative headquarters at West Hartford, Connecticut

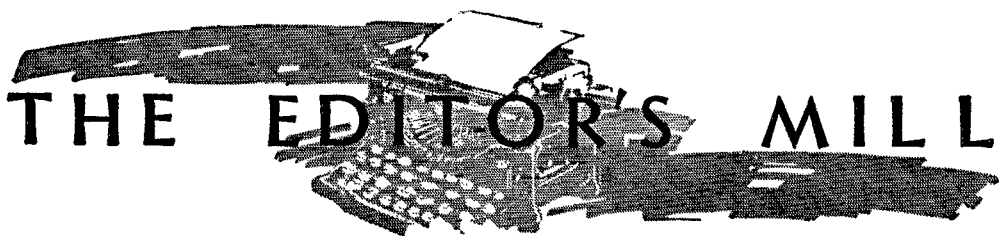

# THE EDITOR'S MILL

A CORRESPONDENT kicks holes in one of our recent editorials in which we suggested that, although the definitions of strengths in the RST system were not precisely the same as in the old system, the differences are negligible in practice. He wants to know if we ever compared the two and noticed the discrepancies in the middle range where most reports fall.

Ironically enough, the reason there is no practical difference between the two systems is because almost everybody uses the R list and simply calls it RST for convenience. You can check this for yourself by noting that there aren't enough 8's handed out in DX work to-day to justify the assumption that the operators are actually making careful reference to the S scale. As a matter of fact, we seriously doubt that W2BSR meant to change the system when he originated RST; it is our impression that he simply wanted to rationalize the language. We doubt if one amateur in a hundred could actually accurately define a number in either system. We all more or less hit a level which is influenced by conditions, noise, how far away the other station is, and similar factors—all of which operate to make the system meaningless in a quantitative sense but satisfactory from the qualitative standpoint. We doubt if many truthful amateurs would pretend that their S8 report on a G station is the same on a good night as it is when only a few signals are coming through, or that the J they report as S6 is anywhere near the same actual strength as the W station to whom they give S6. We seem to set the figure 5 as representing a fairly satisfactory signal for the circumstances and then work both directions from there to the obvious ends. Almost everybody does the same thing—it's as if we can't help it—so we understand each other.

But there's a laugh in this. It's really deplorable: We act as if we had a different standard of strength for difficult DX yet, aside from the sound of signals, the very way in which we often locate such signals is to ignore the S7, 8 and 9 signals from W stations and carefully examine each S4, 5 and 6 signal to see if it is DX—proving that we know they're weaker. What consistency!

When anyone attempts to graduate signal strengths from 1 to 9, he sets up for himself some sort of a scale, depending upon his ear and his judgment, and we believe that he can rather accurately judge all signals that come in to him dur-

ing one period of operation, with respect to each other. That's all any such system can do. The fellow with a rhomboid and a sniggle-snooper receives signals at an altogether higher level than the chap with a blooper working on the bed-spring, yet you'll agree that (neglecting directional effects and fading patterns) they'll call the same sigs S9, and the same S5 (possibly with variations from S4 to S6 attributable to human inconsistency). So whether we call the system QSA, QRK, R or S, we find every man calling his very loudest signals 9, his very weakest ones 1, and attempting within the limits of human frailty to grade the other strengths in between. And don't we do the same thing on tones! If you don't believe it, just study the tone definitions carefully.

In all the talk that goes on about this subject it is important to remember that these systems of aural judging can give only qualitative reports. For general amateur purposes that is almost always sufficient, since we're not so much concerned about how we're doing in an absolute way as we are with how we're doing by comparison with someone else who may be doing better. Hi! Even the calibrated attenuators with which some receivers have been equipped are but little better, since they are measuring signal input to the receiver and that depends upon whether the antenna is a diamond or a yard of bellwire. For many branches of our work it would be interesting to know the actual field strength at receiving points and we have a hunch that the day will arrive when we won't be satisfied with anything less than reports in terms of microvolts per meter. What we really need, then, is a nice combination preselector and frequency meter and field strength measuring set to retail for about three bucks fifty. Any volunteers?

K. B. W.

WE HAVE in our Correspondence columns this month a letter with this potent thought:

"Straight technical information is as free as air compared with the days when it was nearly all self-instruction, but sensible, practical operation doesn't come out of books."

Think back a bit, you old timers, and reflect how much truth there is in that. We did, with astonishment. Go back twelve years, for instance.

There was no *Handbook* then, even, let alone the multitude of lesser helps available to the neophyte to-day; the *Handbook* did not arrive until 1926. It was in 1925 that Johnny Clayton first introduced equipment designed specifically for beginners in *QST*; until then the newcomer had to attempt his own version of the equipment used by the big shots of the day. Nor did this represent laxity on the part of *QST*'s editors—that was the way things worked then. There were only a relatively few pieces of equipment that could be incorporated in the amateur rig, and there was proportionately little knowledge as to what they did, and why—little compared with present-day knowledge, at least. Putting together ham gear was a matter of individual experimentation; there were few set rules, and little in the way of established technique. Fortunately, it was so relatively simple that beginners did, then as now—but then more by a slow and arduous acquisition of knowledge and experience than now—get rigs going and get on the air. They learned by doing, in the painful school of experience. Now ham radio technical knowledge is, in comparison, spoon-fed.

But look at the other side of the picture—the operating side. Those were the days when superlative operating was the acme of amateur success—when “Chain Lightning Hill” and many

another old timer and old-time circuit were famous because of their *handling* of amateur equipment, their *operation* of their stations. The gear then was pitifully crude, woefully ineffective. Yet their performances with it were marvels of finished operation. We are reminded of the early barnstorming airplane pilots, rambling around the country in haywired crates so insecure none would be permitted to leave the ground to-day. Yet they were true airmen, with a feel for flying that is generally conceded to be conspicuously lacking in the modern school of “aircraft engineers.” So with ham operators.

Maybe we're guilty of looking backwards, yet it seems that a lot of that old spirit could well be restored in amateur radio. We have some good operators, to-day, true—but far too few. The great bulk of amateurs are—we blush to say it—less interested in *operating* their stations than they are in the mere unskilled *use* of them. We have the same condition on the highways. We call them “Sunday drivers.” Are you one of amateur radio's Sunday drivers? If so, take a leaf from the book of amateur radio's old timers and try a little real *operating* for a change. It will take practice, and experience, and even a little self-discipline—but you'll find it worth the effort.

C. B. D.

## Radio Course Starts

THE winter course in “Modern Radio Theory and Practice” starts Monday, October 4th, at 7:30 P.M. E.S.T. on 6040 kc. over Station WIXAL, Boston. Which is important news.

All too few of us are taking advantage of the remarkably valuable programs of instruction in radio and other scientific subjects made available by the World Wide Broadcasting Foundation under the direction of Mr. Walter S. Lemmon. This is an endowed non-profit organization devoted to educational work. Their courses in radio work the past several winters have been perfectly splendid and are well worth the attention of amateur workers. They provide the equivalent of college class-room instruction in radio. We suggest that amateurs interested in learning a bit more about how radio works take steps to enroll at once. Clubs may profitably arrange for group listening, possibly followed by ragchews on the evening's lesson. Newcomer students of the art will find the course particularly valuable.

There is an enrollment fee of \$1, which brings the enrollee a set of blueprints, enabling him to follow the lecturer at Boston who is using the master blueprint. The fee also covers the privilege of sending in questions. The instructor for the winter course is Mr. C. D. Belcher, formerly U. S. Radio Inspector at Boston.

The first section of the course, consisting of 8 regular lectures and 2 introductory lectures, covers the ground through vacuum tubes. The scope of the course is illustrated by the October schedule:

- Oct. 4—Introductory Lecture.
- Oct. 11—History of Radio—Life-saving at sea, the amateur, commercial operation, broadcasting.
- Oct. 18—Simple forms of D.C. Machinery.
- Oct. 25—Alternating Current—Theory and Uses.

For enrollment and particulars, address Station WIXAL, University Club, Boston, Mass. Several thousand amateurs profited by the course last winter, and we think it is emphatically worth any ham's time. Prompt action is necessary to get under the wire, so as to receive your instructions and blueprints for the beginning of the course. WIXAL has 20 kw. and lays down a nice signal over most of the country at that hour.

Incidentally, WIXAL broadcasts Ursigrams on 11.79 Mc. from 4:55 to 5 P.M. E.S.T. on weekdays from Monday through Friday. These are daily bulletins of ionosphere heights, magnetic storm data, etc., prepared by the U.R.S.I., invaluable to serious scientific workers in this field and a great aid to amateurs engaged in foretelling DX conditions, correlating observations with natural conditions, etc.

Better enroll for that course right away.

# Radio Control of Model Aircraft

## Details of a Simple System Adaptable to Any Unmanned Mobile Unit

By Ross A. Hull\* and R. B. Bourne\*\*, W1ANA

Here is another field in which the ham is destined to play a big part. At first glance the controlling of models by radio is not ham radio as we ordinarily understand it. On second glance, though, it becomes a perfect legitimate ham activity and one to which the amateur falls heir because he alone (aside from scientific institutions with experimental licenses) is privileged to do the transmission. The game is as chock full of problems as it is of thrills and it will be interesting to see just how far we can get in a year or two of activity. The work reported here was done exclusively with a model sailplane. It was simplified by the absence of ignition interference but enormously complicated by the absolute need for precise control from the first moment. The same technique applied to gas airplane models should serve to offset the present steady growth of legislation against their use in free and uncontrolled flight.—EDITOR

THE application of ham radio in the operation of controlled model boats, airplanes and autos has received relatively little attention to date. But it must be said that those individuals who have played with radio control of models invariably reveal a tremendous enthusiasm for their game. During the last few years, coinciding with the development of successful gasoline-engine-driven model airplanes, we have seen a steady climb in the interest in the subject and have been called upon quite frequently for details of a practical system.

Most hams are usually far from being one-hobby men and one discovers, almost invariably, an interest in the other sciences and the crafts. A common interest in ham radio, aeronautics, model building and photography, is almost the rule. We happen to be built that way and our interest in aircraft led us, this summer, to take an active interest in this problem of radio control. Fortunately, just as our interests really blossomed, we were able to take a brief trip to the soaring contest at Elmira, New York, and found (amongst the usual array of interesting things) a radio-controlled model sailplane, built by Carl W. Thompson, Jr., of Wilmington, and equipped with radio gear by H. M. Plummer,

W3DIA. The ship was arranged to fly ordinarily with right rudder and the armature of an old-time sounder operated from the receiver served to give an alternative left rudder. The ship made several successful hops with the control working but an untimely crackup ended the experiment. We were fortunate enough to be able to acquire the remains and so, on our return to Hartford, were able to go right ahead with an attempt at the control problem. Since that time we have had more than a hundred flights (with some fifteen severe crackups!) and the whole equipment has been rebuilt and rebuilt until substantially nothing is left of the original. But if anyone thinks that the program was tedious work, they're crazy! We have had our full share of thrills in this ham game but the business of controlling a dizzy airplane galloping across the sky has set a new all-time high for sheer fun.

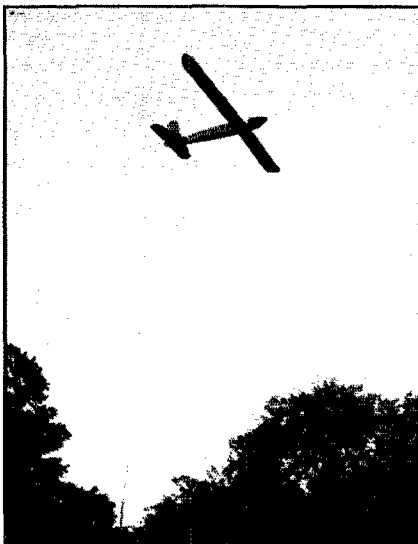

Photo Courtesy Hartford Courant

### THE EXPERIMENTAL RADIO-CONTROLLED SAILPLANE IN FULL FLIGHT

Flying an elongated figure-of-eight course above the soaring ridge presents few real difficulties once the ship is in the clear. Free-dodging is another business! The model is 13 feet span; weighs 10 pounds complete.

### THE PROBLEM

A casual glance at the problem would lead anyone to imagine that it is all a perfectly simple business.

All one needs is some sort of receiver that produces enough change in the plate current of an output tube to operate a relay of some kind, the relay then being connected to a control device which produces the necessary effect. Closer examination, however, reveals a host of problems which are juicy morsels for any

\* Associate Editor, QST.

\*\* Maxim Silencer Co., Hartford, Conn.



experimentally inclined ham. We have solved a few of them, temporarily at any rate, but it must be said emphatically that the scheme to be outlined is the result of a first try. Our only hope is to open the subject wide in the knowledge that a few hundred of us hammering at the same objective will have the problem really licked in short time.

The basic method which has been widely used for model control is that of a selector switch similar to the affair found in automatic telephone installations. It is a gadget which closes one of a series of circuits, depending on the number of pulses transmitted. The circuit so closed is then caused to operate a reversible electric motor or some such device for producing the movement of the control element. This type of equipment has not been used with any appreciable success in model airplane work due, we believe, to its inherent complexity and to the necessity of carrying considerable weight in the batteries for motive power.

A brief study of the subject showed at once that the results were prone to be in inverse proportion to the complexities of the equipment and it became obvious that some extremely simple system was called for. So we ruled out the selector switch and started from the bottom.

#### HITTING AT SIMPLICITY

Having had earlier experience with the effectiveness and efficiency of rubber band motors, we decided to use one to supply the power for control. With a motor four or five feet long we knew that we could "charge" the thing with at least 1000 turns and obviously this would serve for several thousand control motions. The only problem then was to provide some means of triggering off this rubber power and connecting it to the control surface. A further preliminary decision was to use a single control surface only and the logical decision was to use rudder. It was obvious that any reasonably stable plane could look after itself longitudinally. The only basic need was to keep the machine flying in any desired horizontal direction. Anyway, after much fiddling, we ended up with the device shown in Fig. 1—a simple escapement driven by the rubber motor and controlled by an electro-magnet operated in turn from the output tube of the receiver. As can be seen from the sketch, the transmission of a series of dots would result in step-by-step rotation of the escapement and swinging of the rudder from left to right. It was simply a matter of transmitting the desired number of pulses in order to acquire the correct rudder setting. The chief disadvantage of this simple scheme seemed to be that the rudder positions were all in a continuous sequence and that once the rudder had been in the left position and had then been centralized it was possible to get back to left rudder again only by passing through right and center rudder. In actual practice this weakness proved to be of little

consequence just as soon as we had equipped an appropriate ground control system. It then became possible to whip through the undesired but necessary positions in a fraction of a second without causing more than a slight flicker in the flight path. But there were more problems to come.

#### THE RECEIVER

We had left the receiver itself for the last feeling that it would certainly be a cinch. Actually it took about a week of evenings to get a two-tube receiver that would perform with any degree of satisfaction. Even then we had to break down and admit that three tubes were really called for if all the desirable features were to be had. We cannot help feeling that this part of the job is just started. Surely there must be some way of building a simple one-tube receiver capable of operating an inexpensive relay! Fortunately, even the three-tube receiver came well within our weight limit. This sailplane was capable of carrying at least five pounds. Without even trying hard we ended up with a complete receiver, power supply and control system that weighed slightly less than three pounds. With some refinements even the present setup could be pulled down to  $2\frac{1}{2}$  pounds—a figure within reason even for single-engine models.

Some of the earlier control systems made use of the beat produced by an autodyne receiver to actuate the control tube—the frequency usually being on the 3.5-Mc. band. This procedure we ruled out at once as a result of practical experience in attempting to obtain a sufficiently stable beat. Since it was futile to control the model without being able to see it and since we were aiming at the utmost simplicity we decided to use the 56-Mc. band. There were two alternatives available—to use a continuous carrier with pulses of tone to operate the relay or to permit the characteristic rush noise of a superregenerative detector to keep the relay open, then applying pulses of carrier to close it. It works out that the former scheme will allow a simpler receiver but that the latter method is infinitely preferable because of the negligible interference which its operation causes. Fig. 2 shows the two-tube receiver with which successful operation may be had if pulses of tone are used on a continuous transmitted carrier. The first part of this circuit is a simple superregenerative detector using a 30 tube and fitted with a simple filter for the quench voltage. The output tube is a 1F4—chosen because of its high mutual conductance. The grid condenser and leak in its grid circuit allow the tone voltage to develop a negative grid bias and so produce a plate current change from about 2 to 0.5 ma. This method of obtaining a plate current change has so far proved infinitely preferable to the use of fixed bias with the tube normally operating almost at cutoff. But the 1F4 is the only tube we have met so far that will do the job. The

total filament current of the set is 0.18 ampere and the plate current when idling about 3 milli-amperes. This should allow a B-battery life of at least a couple of hundred hours even with the very smallest batteries available. The life of a pair

plates bent until the capacity between them would seem to be zero. The placement of the antenna appears to be of very little consequence. We used a piece of No. 28 wire taped to the outer covering of the fuselage.

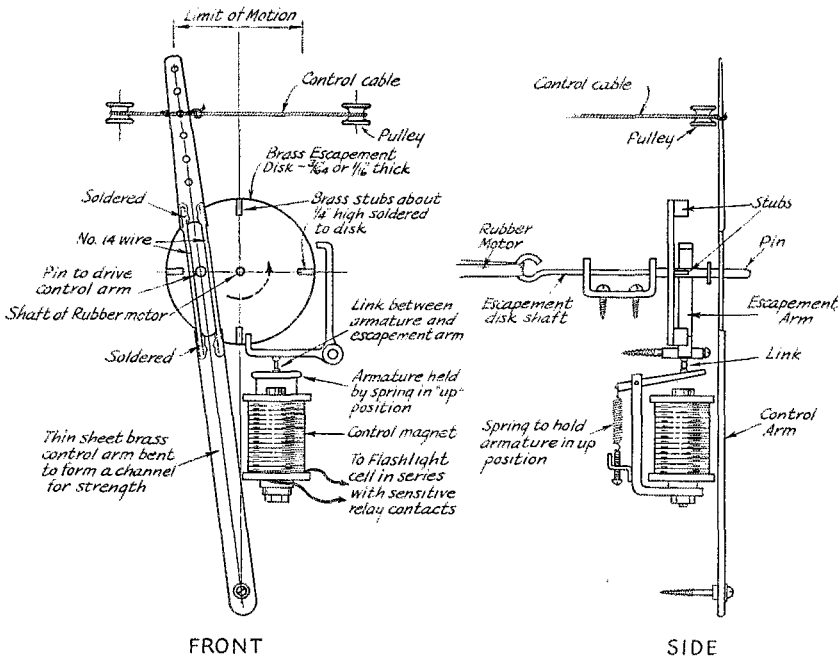

FIG. 1—THE EXPERIMENTAL ESCAPEMENT USED TO CONVERT THE RUBBER-BAND MOTOR TORQUE INTO RUDDER MOTIONS

The escapement disc, turning clockwise in this case, is driven by four strands of one-quarter-inch model airplane rubber. The rotation is limited to steps of a quarter turn by the escapement arm controlled by the electro-magnet connected in series with the sensitive relay in the output of the receiver. The crank pin on the escapement disc carries the control arm from left to center to right, in accordance with its position. No details of the mounting of these components to the bulkhead in the fuselage are given because they will be varied to suit each individual case.

of flashlight cells for the filaments will probably not be more than half a day of continuous operation but it will be 20¢ well spent.

The apparatus in such a receiver, as we will later indicate, should be mounted on a small piece of plywood. The gear may be packed on the base in almost any fashion, the only requirement being that everything be attached very sturdily and that tubes be placed where they cannot bump elbows with each other or with the audio transformer. A vernier dial was found unnecessary providing a 6-inch extension rod (a piece of balsa wood) was used for tuning. No particular difficulty should be had in adjusting the superregenerative detector though failure to superregenerate or a desire to howl may have to be cured by a change in the value of the grid leak or in the setting of the tap on  $L_1$ . The length of the antenna and the size of the coupling condenser  $C_5$  will also have some effect in these respects.

An antenna not more than two or three feet long should be adequate, while  $C_5$  can have its

#### THE THREE-TUBE MODEL

The business of leaving a carrier running did not appeal to us at all. It was decided to add three or four ounces to the receiver and include the third tube found to be necessary when the pulses were to be carrier only. Fig. 3 shows the complete circuit of this receiver. The detector tube is again a 30 in a superregenerative circuit of slightly different type from that shown in the two-tube receiver. The detector circuits are actually interchangeable in the two receivers. It just so happens that the arrangement shown in Fig. 3 gave us rather better freedom from howling than the previous ones when the extra tube was added. It will be noted that the grid leak runs to positive high voltage in both receivers. This connection seems to iron out some of the howling difficulties and results in smoother operation. The 1B5 was chosen because of its high amplification factor and is considerably better than the 30 as the intermediate amplifier. It will be seen that the diodes are not used though a very slight improvement in

the operation of the output tube is found if one of the diodes is connected to the grid of the 1F4. This receiver need occupy very little more space than the two-tube model and, as far as we can see, is the more practical rig of the two. In its operation, the rush from the superregenerative detector

the receiver with an antenna more than is absolutely essential. With this rig we are in the habit of operating without an antenna at all and still manage to get ample control signal at distances of a mile or so with a 30-watt transmitter. For our purposes this was sufficient.

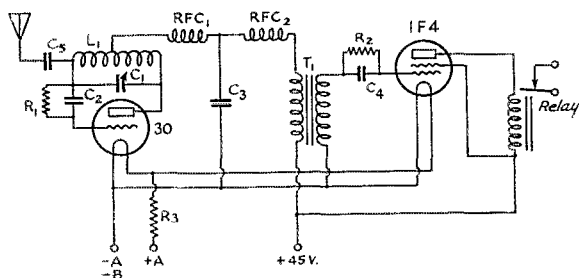

FIG. 2—THE TWO-TUBE CONTROL RECEIVER

C<sub>1</sub>—17.5- $\mu$ fd. midget variable (Hammarlund HF-15). (Some of the larger types can't take it in a rough landing.)

C<sub>2</sub>—100- $\mu$ fd. midget fixed condenser.

C<sub>3</sub>—0.01- $\mu$ fd. fixed mica condenser.

C<sub>4</sub>—0.002- $\mu$ fd. fixed mica condenser.

C<sub>5</sub>—M-30 National padding condenser adjusted to its minimum setting.

R<sub>1</sub>—1 to 5 megohm  $\frac{1}{2}$ -watt resistor; experiment usually necessary.

R<sub>2</sub>—2-megohm  $\frac{1}{2}$ -watt.

R<sub>3</sub>—5-ohm fixed resistor.

RFC<sub>1</sub>—Ohmite u.h.f. choke.

RFC<sub>2</sub>—Bud 125 millihenry choke.

L<sub>1</sub>—8 turns No. 14 wire  $\frac{1}{2}$  inch diameter, turns spaced the wire diameter.

T<sub>1</sub>—Any very small audio transformer. The one originally used is a push-pull affair with the whole secondary used.

The relay is an Eby Type ER12 with a 5000-ohm winding.

causes the plate current of the 1F4 to drop to about 0.6 ma. A transmitted pulse of carrier shuts off this rush noise, relieves the 1F4 from its negative grid bias and permits the plate current to rise to about 2 milliamperes. This change is ample to close the relay providing the tension spring is adjusted carefully. Naturally, the relay contacts are connected in opposite fashion in this receiver to those in the two-tube receiver. This model is almost as economical in operation as the simpler set. The plate current of the 1B5 is a small fraction of a milliampere, its filament drain 0.06 ampere. Because use is made of the rush noise from the detector it is important not to load

BATTERIES

It is most fortunate that the battery manufacturers have been weight conscious in recent years, the modern midget "B" battery being really the key to the whole situation. In this work we have used two types—the Burgess W30BPX and the Eveready X203. Both of these weigh approximately 10 ounces and are capable of operating even the three-tube receiver for much more than a hundred hours. For the experimenter who insists on the absolute minimum of weight there is the Burgess W30FL weighing 8½ ounces and still capable of almost a hundred hours of service.

For filament and control magnet batteries we have used ordinary flashlight batteries exclusively. They have the merit of low cost and reasonably light weight and are, of course, available anywhere. The very small sizes could be used in cases where every gram counts.

#### THE TRANSMITTER PROBLEM

Because model aircraft or even model boats will usually be operated at points unavailable to power lines it is very desirable that the transmitter should be operated either from a 6-volt storage battery in an automobile or from dry batteries. So far we have used only an automobile

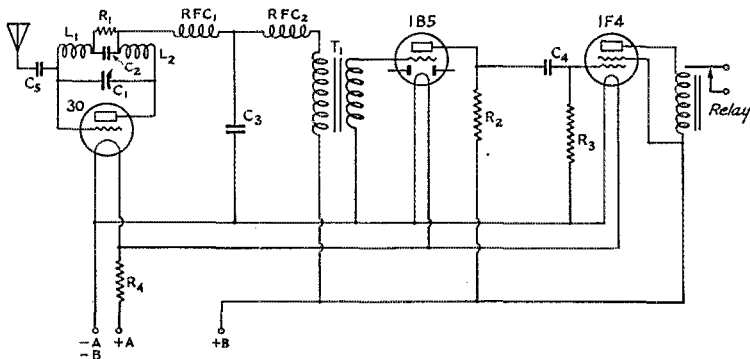

FIG. 3—THE CIRCUIT OF THE PREFERRED RECEIVER

C<sub>1</sub>—17.5- $\mu$ fd. midget variable (Hammarlund HF-15).

C<sub>2</sub>—100- $\mu$ fd. fixed condenser.

C<sub>3</sub>—0.01- $\mu$ fd. fixed mica.

C<sub>4</sub>—0.01- $\mu$ fd. fixed paper.

C<sub>5</sub>—M-30 National mica padding condenser, with the upper plate bent at right angles to the lower.

R<sub>1</sub>—1 or 2-megohm grid leak.

R<sub>2</sub>—150,000-ohm,  $\frac{1}{2}$ -watt fixed resistor.

R<sub>3</sub>—2-megohm,  $\frac{1}{2}$ -watt fixed resistor.

R<sub>4</sub>—5-ohm fixed resistor.

RFC<sub>1</sub>—Ohmite u.h.f. choke.

RFC<sub>2</sub>—Bud 125 millihenry choke.

L<sub>1</sub>, L<sub>2</sub>—Each 4 turns No. 14 wire,  $\frac{1}{2}$ -inch diameter.

The audio transformer and relay are the same as those described for Fig. 2.

transmitter. It consists of a pair of 45 tubes—with their filaments connected in series—in a simple fixed-tuned-grid tuned-plate circuit similar to that given on page 260 in the current *A.R.R.L. Amateur's Handbook*. A 6A6 or 6N7 tube would also serve the purpose admirably. We used the 45 tube simply because the rig was already available. We supplied plate voltage from a Mallory Vibropack giving 300 volts at 100 milliamperes but a pack of lower power or a set of B batteries would be quite satisfactory. When operating with carrier pulses alone the transmitter is, of course, a very simple affair. The use of tone pulses will require a modulator, the general nature of which can be decided very rapidly by anyone familiar with 56-Mc. work or anyone willing to glance through the *Handbook*. Personally, we are strong for the elimination of the tone business.

The transmitting antenna may be the usual fishpole affair or a half-wave antenna strung between bamboo poles. It may be fed either with a 72-ohm line to the center of the half-wave antenna or with a tuned line to one end. The problem of rigging this transmitter and adjusting the antenna until it is really doing some radiating will not be a problem at all to any present-day ham.

#### THE CONTROL STATION

First experiments were conducted with an ordinary key, the pulses being delivered in the

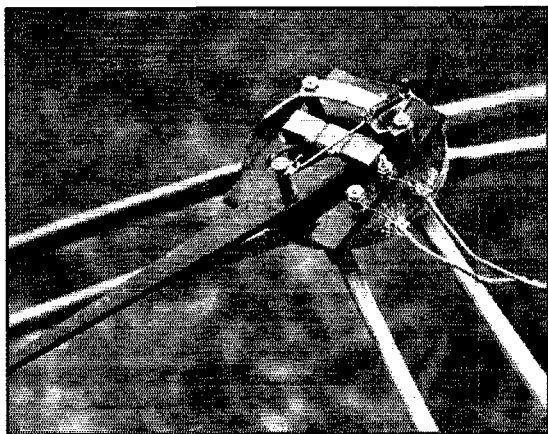

A CLOSE-UP OF THE BOURNE CONTROL STICK

The stick itself is pivoted at the post right in the center of the picture. Contacts are made between a brass screw-head on the stick and depressions on the brass strip crossing it. The curved strip in the rear has notches into which a half-moon shaped rocking ratchet runs. This ratchet, seen near the nut toward the right corner will permit, in its present position, moving the stick from left to right. Upon reaching the right position the ratchet rocks over to the opposite side, then preventing the stick from being backed off once it has been moved toward the center position.

necessary amounts in the usual fashion. This was a failure from the start. It was found almost impossible to remember in what position the rudder was supposed to be and several crackups resulting from a misunderstanding between the pilot and the plane caused us to develop some sort of control device. The first model was a 10-inch wooden con-

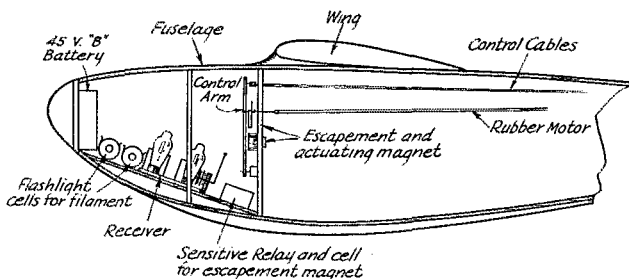

FIG. 4—SHOWING THE PLACEMENT OF THE EQUIPMENT IN THE FUSELAGE OF THE EXPERIMENTAL SAILPLANE

Having no engine to carry the center of gravity of the machine forward, the equipment is all placed ahead of the wing. With the gas-driven model, the gear would be grouped at the center of gravity and the actual arrangement would naturally be varied to suit the particular fuselage in which it is installed.

control wheel with a vertical handle mounted near its rim. Contacts were attached to its under surface so that as the disc was rotated a complete revolution four pulses would be transmitted. A simple ratchet was attached underneath so that the disc could be turned in one direction only. Rotating this disc in a clockwise direction, and starting from a position with the handle at the center rear, produced right, center, left and again center rudder positions. The device still remains a very practical one for this type of control. The Bourne control rig illustrated is, however, our current favorite. It is basically a control stick fitted with a ratchet of such design that it will move to left, right, left, right and not in the reverse direction. Contacts are made as the control arm passes from the center to either side position.

In practice these control gadgets are connected on the end of a few hundred feet of twisted pair and mounted on a tripod. In this fashion, the pilot is permitted to adjust his location to give the best possible view of the flight.

An alternative control scheme would be to use voice modulation at the transmitter in conjunction with a voice-controlled relay such as that described on page 348 of the current *Handbook* or in the November, 1936, issue of *QST*. With the time delay adjusted properly one could demand by voice "left" and the rudder would move to give that sort of turn. The words "now right"

(Continued on page 62)

# With European Amateurs on the Bucharest C.C.I.R. Trip

By James J. Lamb,\* W1AL, and John C. Stadler,\*\* VE2AP

**T**HERE is a great deal more to international amateur radio than DX contacts over the air; and the International Amateur Radio Union is of much greater significance than just a formal "paper" organization of national radio societies. The truth of this was emphatically brought home to us in personal visits with representative amateurs of European national societies in traveling to and from the Bucarest C.C.I.R. at which we represented the I.A.R.U. as reported in September *QST*.<sup>1</sup> From our first greeting by the German amateurs on landing in Hamburg to the last farewell to our hosts in England, there prevailed the same evidences of mutual respect, sincere will to cooperate, sympathetic understanding and true friendship—all of those things which go to make up that deep-founded thing we call "amateur spirit." It runs as the common strong thread through the lives of thousands of hams of different and even opposite political and

been officially delegated by the D.A.S.D. to meet us. Mr. Norman Guy, a former English amateur living in Hamburg, joined us in an early morning cup of coffee and a short rag-chew at the main railway station—all there was time for before our scheduled departure for Berlin. It was here we were first introduced to a method of identification for "blind" meetings which we were to encounter again—and which proved to be surprisingly effective. D4EWJ simply strolled about the large concourse of the Hamburg main railway station holding a copy of *QST* so that all he passed might see it. One glimpse of the familiar red cover, and we were meeting him with outstretched hand.

Upon our arrival in Berlin several hours later we were again cordially met and given a second introduction to German hospitality, this time by Werner Slawyk, D4BUF, and Otto Graff, D4BAF, regional traffic head and traffic manager of the D.A.S.D. We were immediately acquainted with the schedule which had been arranged for our four days in Berlin—which, with traditional German thoroughness, was presented to us in the form of a typewritten program in which every waking hour (and some that ordinarily should have been spent in sleep) was accounted for.

During the first afternoon we visited the fine new D.A.S.D. headquarters establishment in Dahlem, where we were conducted on an informal inspection tour through the various departments, including the central headquarters amateur station of the D.A.S.D. communication system and the radio parts store which the society operates for its membership. This novel feature of the organization is an especially interesting one, made necessary by the lack of commercial distribution facilities such as we take for granted in the U.S.A. The D.A.S.D. not only conducts the store for its members, but designs the components and has them made up by manufacturers suitably equipped to do the job at reasonable cost. The net result is that the German amateurs are able to buy essential parts at prices which are about the same we would pay for similar types. The variety is somewhat limited, of course, which tends to place restriction on the design of complete transmitter and receiver assemblies, and might seem to curtail possibilities



AT D.A.S.D. HEADQUARTERS IN BERLIN

Left to right, Von Bulow, Stadler, Slawyk, Admiral Gebhardt, Lamb and Graff.

religious faiths, surmounts the barriers of nationality and languages, and knows no frontiers. Because of it we felt ourselves to be at home wherever we were and knew we were never among strangers—because there were always radio amateurs.

Immediately after our arrival in Hamburg, we were met by Herr Rapcke, D4BWJ, who had

\* Technical Editor.

\*\* Canadian Broadcasting Corporation, Montreal, Canada.

<sup>1</sup> J. J. Lamb and J. C. Stadler, "The Fourth C.C.I.R. at Bucharest," *QST*, Sept., 1937.

of technical development. However, the D.A.S.D. has standardized transmitter and receiver designs which are generally followed, so what might seem like a handicap to us is actually turned into an asset for their practical purposes. Most of the receivers are of a simple regenerative type, while the transmitters are of progressive unit construction, starting off with a low-power electron-coupled oscillator. The tube business is a monopoly in Germany, and the high "bottle" cost necessarily imposes an economic limit on transmitter power—apart from power restrictions imposed by regulations.

Following the afternoon visit to the D.A.S.D. establishment and supper with D4BUF, we were introduced to German television at his home station. Here we witnessed reception of the regular television program service in which D4BUF is employed and which has been in operation under government auspices for some time. The receiver was of the cathode-ray type, of recent design, and the black-and-white picture reproduction was surprisingly good, considering that the transmission was only 180-line with mechanical ("flying-spot") scanning. This system, we were informed, was to be replaced shortly with the more modern type using electron-camera pick-up with a 441-line picture, following American practice. We also learned of the experimental work which was being done with pictures of 700 lines and more, and of

only for demonstration and test purposes. There is practically no "home" television as yet, although it is promised for the early future.

The next morning we were again taken to the D.A.S.D. headquarters (in the "official" motor



ON ARRIVAL IN BUCHAREST

Left to right, YR5VC, VE2AP, YR5AA, YR5NM, W1AL, YR5TY and YR5TI. Photo by D4XFV.

car furnished by our hosts for transportation throughout our visit) for the formal meeting with Vice-Admiral Gebhardt, president of the D.A.S.D., Vice-President and Treasurer Von Bulow, CQ Technical Editor Rolf Wigand and QSL Manager Bruno Garnatz. Following Admiral Gebhardt's gracious greeting and our response on behalf of I.A.R.U. President Woodruff, we began informal discussion of amateur problems and exchange of views, the conversation on amateur matters continuing through luncheon in the headquarters' handsomely appointed dining room.

That evening, after visiting the Berlin broadcasting transmitter at Steglitz in the afternoon, we were guests at the official dinner given by the D.A.S.D., with Admiral Gebhardt presiding. In addition to the D.A.S.D. officials, here we also met representatives of several government agencies and radio services with whom it was our pleasure to discuss amateur matters.

In the following days we inspected the Berlin long-wave and international short-wave broadcasting facilities, the Telefunken laboratories and the central receiving station at Beelitz. At the broadcasting studios interviews were recorded for subsequent transmission over the *Berlin-sender* and the short-wave service to America. Riding about between the various points gave us an opportunity to enjoy the beautiful German countryside, which we agree is all we had heard it described as being. This was especially true of Potsdam, where we were taken by Admiral Gebhardt, Werner Slawyk and Otto Graff for Sunday afternoon's outing. That evening we said



THE SUMMER HOME OF FSEF AT POMPONNE, WHERE HIS WELL-KNOWN STATION IS LOCATED

the projection-type cathode-ray reception which had been developed along lines similar to the projection technique which was demonstrated in America at about the same time. The prices of the available receivers in Germany are quite high (the one we saw demonstrated would cost about a thousand dollars) and the programs are received

'good-bye' to the Admiral with real regret, realizing that we had enjoyed the hospitality of a fine gentleman and a good friend. The same feeling of regret was ours at leaving our other friends—to the last handclasp from Bernard Vermehren as the Nord Express pulled out of the Berlin station for Bucharest.

#### BUCHAREST—AND THE YR'S

Following the pleasant but strenuous four days with the D4's, the tiring 36-hour railway trip



SNAPPED BY G2MI AT HIS HOME, WITH THE YF, JUNIOR OP AND JACK CLARRICATS

from Berlin to Bucharest, by way of Breslau (Germany) and through the mining regions of Poland, brought us to Bucharest in the late afternoon of the second day pretty well fagged out. But no sooner did we step out on the platform in the Bucharest station than fatigue was forgotten. A smiling chap with a copy of *May QST* in hand stepped around in front of us. "Mr. Lamb?" said he. Forthwith we were surrounded by no less than a dozen YR's and a visiting D4 who had come down to greet us. The *QST* identification was in this instance a jump ahead of that in Hamburg, because the *May* issue happened to have a cover illustration showing a southwest shot of J. J. L. by which Paul Popescu-Malaesti, YR5AA, made the identification from that quarter!

That evening we had the first scheduled contact with W1EH in West Hartford from YR5AA, and were able to report on our safe arrival and good health, and to receive the first news from home that we had had since leaving two weeks before. These schedules were kept twice weekly throughout the time of the conference, through the always-friendly coöperation of YR5AA, YR5EV and others of the gang, even when it must have caused considerable inconvenience to them. The YR gang also gave us valuable assistance in activities connected with the conference.

Except for the YR5AA schedules, there was little time available for ham contacts during the period of the conference and it was not until the last weekend that we were all able to get together again. On the evening of June 5th the Roumanian amateur society, the A.A.R.U.S., received us officially at their headquarters. Here we met Dr. Savapol, YR5AS, president of the A.A.R.U.S., and responded to his greeting by conveying to him the best wishes of Dr. Woodruff and the other officers of I.A.R.U. and A.R.R.L. With the formalities over, we all proceeded to dinner and an evening of informal discussion of amateur problems. The A.A.R.U.S. was at that time preparing to make application to the I.A.R.U., and this meeting gave the opportunity for discussion of the various details of the affiliation, as well as of other matters connected with the international amateur picture. Most of this discussion had to be in French, and accordingly was handled by J. C. S. As a consequence, the A.A.R.U.S. application for admission to I.A.R.U. was brought back to headquarters with our hearty recommendation for approval, and is now being voted on by the member societies of the Union. On the following day, Sunday, a ham party composed of Dr. Savapol, Messrs. Popescu-Malaesti, Andriescu, Nicolescu, Bentaud, Militaru, Ciocos and YF, and ourselves, visited Sinia and Brasov in the mountainous country north of Bucharest. This presented a splendid opportunity to exchange further ideas and to examine especially the possibilities of more effective government recognition of amateur radio in Roumania. One fruitful result of the tentative plans then discussed is that rapid progress already has been made by the A.A.R.U.S., and a new and greatly improved status for amateur radio in Roumania is promised for this fall.

Bright and early Wednesday morning, following the close of the conference on Tuesday, the 8th, 5AA, 5EV, 5PC and his YF were at the Bucharest station to see us off on the Simplon Orient Express for Paris. Our last thoughts on leaving them were as if we had said good-bye to American hams whom we knew well. Roumania or at home, the ham spirit was there. Except for the superficial differences of language and customs, we might have been among W or VE friends.

#### PARIS—THE R.E.F. AND R.B.

Exactly two days and nights of continuous travel in a stuffy compartment brought us to Paris and ground more familiar to both of us from previous visits and acquaintance with French hams. Hardly had we had time to round up our baggage and get settled when a delegation headed by F8EF called on us at our hotel. We were immediately taken to the Paris home of Mr. Auger, where we were joined by Mr. Lory, editor of the R.E.F. official journal. Following a delightful

(Continued on page 66)



# A Semi-Universal Exciter With Stage Switching and Plug-In Coils

A 40-watt Output Unit Suitable for Operation on Five Bands

By George Grammer\*

THE double-triode exciter, originally presented in *QST* some three years ago, has met with considerable favor in amateur circles and has since been subjected to a number of modifications by different constructors. Despite a wide variety of circuits, however, some fairly serious operating disadvantages seem to have been neglected by the designers, although not unobserved by the fellows who have built them.

First, the oscillator in the prevalent arrangement is not all that could be desired. Crystal heating is invariably greater with a triode than a tetrode or pentode, using the same plate voltage on both types. With X- and Y-cut crystals, this means greater creep, naturally, besides limiting the output obtainable with crystal safety from a triode. This objection is less serious with low-drift crystals. The second factor, however, may be more important with any type of crystal; it is the fact that in any triode crystal oscillator the oscillation frequency is considerably more dependent upon circuit constants than is the case with a tetrode or pentode. Furthermore, the triodes in a 53 or similar type of double tube are the worst kind from this standpoint because the amplification factor is high.

It can of course be argued that the importance of this feature can be overemphasized because the frequency changes occur only when the circuit is being tuned, and it isn't common practice to twiddle dials while a transmission is in progress. For work well inside a band it probably doesn't matter—except in some special cases—whether the frequency is 7075 or 7080, so long as the signal stays put on either one—and it generally will. But it's a different matter when the frequency is close enough to the edge of a band so that a few kilocycles make the difference between "in" or "out." Add to this the fact that many crystal manufac-

turers furnish calibrations on the basis of a pentode oscillator and you have a sum which may add up to the wrong answer. So much for the oscillator.

Turning now to the doubler stages, it seems to be customary to connect all the stages in a successively-doubling string, picking output from the one on the desired band. When this is done the idle tube sections usually draw considerable plate current because the plate tanks go out of reso-

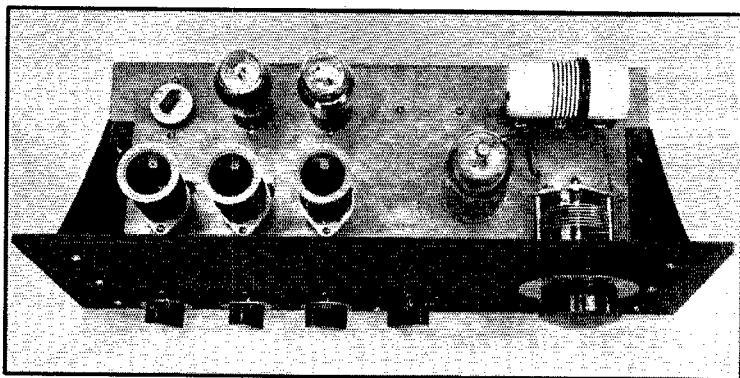

THE PANEL AND TOP-OF-CHASSIS LAYOUT OF THE 40-WATT EXCITER

The tubes are a 6V6G, 6N7G, and 807. Four bands can be covered with one crystal; plug-in coils make the unit adaptable to any band or crystal from 1.75 Mc. to 28 Mc.

nance, and while the active ones may be tuned "on the nose" for maximum output, the unused ones are neglected. This situation probably is at its worst where a switch is used to pick off the desired frequency, although it can be bad enough where separate links are used on each stage. Fixed tuning also aggravates the condition. When voltages as high as 400 are used on 53's or similar types, the plates often run red under this treatment, resulting in grid emission, creeping plate current, and eventually in unduly short tube life. Even at normal plate voltage the safe plate dissipation readily can be exceeded under off-resonance conditions, since the rating is only five watts per plate.

The attractive thing about the double-triode exciter is the readiness with which output can be secured on any desired band. Switching stages is so much simpler than switching in tuned circuits, both from the electrical and construction standpoints. This is especially so when a number of

\* Assistant Technical Editor.

bands are to be covered, since the combination oscillator-doublers and ditto doubler-quadruplers not only require about the same number of tuned circuits, but also leave one up against the problem of what to do with all of them on the lowest frequency—as well as to get enough output on the highest. Furthermore, stage switching can be done at a point where r.f. current is low and

circuit diagram is given in Fig. 1. This does not pretend to be a complete-switching unit, although it can be operated on any two adjacent bands without changing any coils, and on four bands with only two plug-in coils for the 807. Essentially, the circuit consists of a beam tetrode oscillator, two doubler stages (in one tube) and a screen-grid beam tetrode amplifier which can be

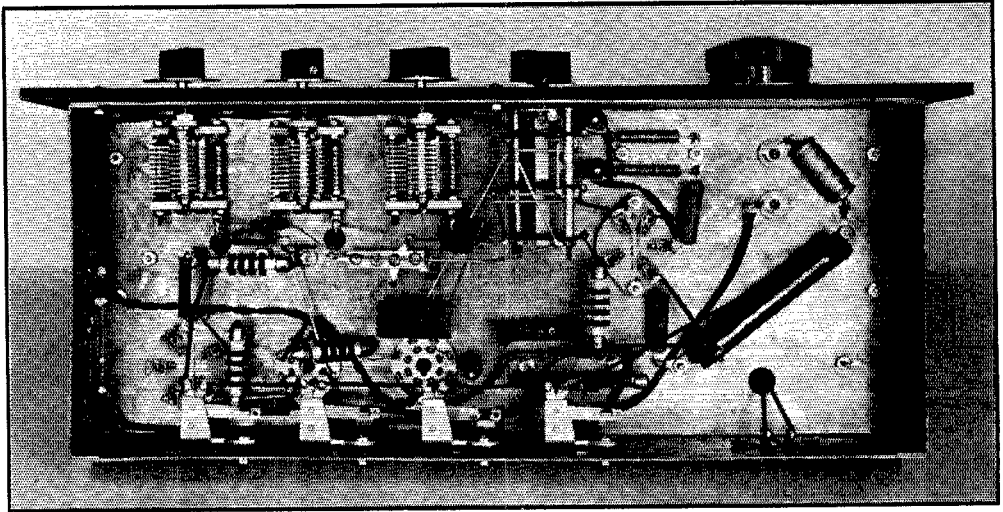

WIRING DETAILS ARE SHOWN BY THIS UNDER-CHASSIS VIEW  
*The layout is explained in the text*

where lead length is of less consequence than in the tuned circuit itself, so that losses and layout are not a major headache.

A combination of the stage-switching idea, with modifications, and the beam tetrode tube offer the opportunity to get an output of 40 watts (with the new ratings on the 807) on as many bands as necessary—without overloading anything. The exceptionally low excitation requirements of the 807 allow us to take liberties in the layout without worrying about having enough excitation, and at the same time permit conservative operation. The disadvantages of the "53" arrangement first cited can be eliminated by doing two things: first, using a tetrode or pentode oscillator instead of a triode; second, making provision in the switching so that unused triodes do not receive excitation. With the high- $\mu$  double triodes this means that the plate current will drop to a safe idling value so long as the rated plate voltage is not exceeded, since the tubes are intended to operate at zero bias. It is not necessary to go over the rated 300 volts to get more than enough excitation for the 807, even on 28 Mc.

#### A PRACTICAL EXCITER

A practical form of such an exciter or low-power transmitter is shown in the photographs. The

connected to either of the three preceding stages. The oscillator, first and second doubler plate coils,  $L_1$ ,  $L_2$  and  $L_3$  respectively, need not be changed for crystal ground for a given band. The switching circuit is so arranged that the grids of unused stages are automatically disconnected from the preceding stage and grounded. The idea readily could be carried out for five-band operation by adding another double triode and continuing the switching system, in which case all crystals could be on the 1.75-Mc. band. However, it seemed to us that the simpler unit here described would be of greater general utility, since comparatively few amateurs care to use 1.75-Mc. crystals exclusively.

In the 807 plate circuit, the tank condenser,  $C_4$ , has sufficient capacity range to permit covering two bands with a single coil. The lower-frequency band will be found toward maximum capacity and the higher-frequency toward minimum in each case. The 807 may be used as a doubler, if desired, for four-band operation from a single crystal; the output and plate efficiency are only slightly reduced from straight-amplifier operation.

The remaining circuit details require little explanation. Capacity coupling is used throughout. The plates of the first three stages are parallel-fed so that the plate tuning condensers can be

mounted directly on the metal chassis. This is convenient, but not essential; if the condensers can be insulated series feed can be used. Parallel-feed in the grid circuits is a practical necessity because with series feed not only the grids but also the biasing circuits would be switched. The 6V6G oscillator, 6N7G doubler-doubler and the 807 screen all operate at the same voltage; with the voltage divider specified the actual voltage at this point is slightly less than 300 volts, with 600 applied. The 6V6G screen runs at a little over 100 volts. A jack is provided for reading plate current to each tube. Series feed is used in the 807 plate circuit, the tank condenser being insulated from the chassis. The various gridleak values specified have been found in practice to give optimum results.

Condenser  $C_{15}$  is a homemade affair of very low capacity, its function being to provide a little feedback additional to that within the oscillator tube itself so that the less peppy crystals will be sure to "start". Even with the additional feedback it is impossible to light a neon bulb on the grid of the 6V6G, and the crystal does not heat in operation. Incidentally, the metal chassis very effectively conducts heat from the tubes, so that the crystal holder may warm up after a period of time. This kind of heat is not the same thing as that

caused by excessive crystal-vibration amplitude, however.

The above-chassis layout is quite simple, as the top-view photograph indicates. Along the back, from left to right, are the crystal, 6V6G, and 6N7G. Directly in front of them are the three low-level plate coils,  $L_1$ ,  $L_2$  and  $L_3$ . These are wound on ordinary receiving forms, and plug into sockets mounted above the chassis on the metal pillars furnished with the sockets. Next in line comes the 807, with part of a tube shield around its lower half for additional shielding, and finally the 807 tank circuit. The chassis is of electroalloy, measuring 7 by 17 by 3 inches.

Below chassis, things are less simple in appearance because of the necessity for running connections to the stage switch. The three tuning condensers,  $C_1$ ,  $C_2$  and  $C_3$ , are mounted directly underneath their associated coils, and are fastened directly to the under-side of the chassis. The "hot" leads from the coils come down through grommetted holes in the chassis; grounds to the coils are made direct to the chassis, on top.

In the oscillator section, at the left, the grid choke is just to the right of the crystal socket; the grid leak,  $R_1$ , connects between the low-potential end of the choke and ground. The plate choke is

(Continued on page 72)

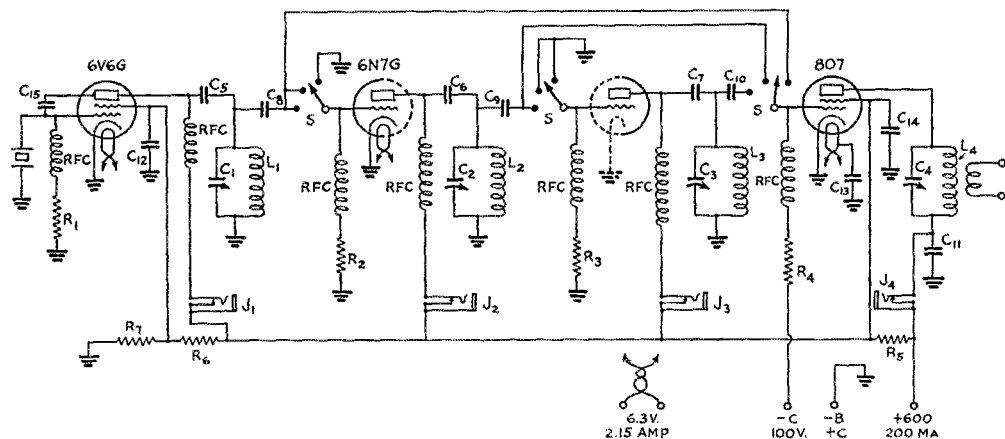

FIG. 1—CIRCUIT DIAGRAM OF THE EXCITER

To avoid complicating the diagram, the two sections of the 6N7G double triode are shown separately.

- $C_1, C_2, C_3$ —100- $\mu$ fd. variable, receiving type (National ST-100).
- $C_4$ —150- $\mu$ fd. variable, low-power transmitting type (National TMS-150).
- $C_5, C_6, C_7$ —0.001- $\mu$ fd. mica, 500-volt (Aerovox 1467).
- $C_8, C_9, C_{10}$ —100- $\mu$ fd. mica, 500-volt (Aerovox 1468).
- $C_{11}$ —0.0025- $\mu$ fd. oil-filled tubular condenser, 2000-volt (Malloy OT-458).
- $C_{12}, C_{13}, C_{14}$ —0.01- $\mu$ fd. paper, 600-volt (Aerovox 684).
- $C_{15}$ —Oscillator feedback condenser (see text).
- $R_1, R_2, R_3$ —25,000 ohms, 1-watt (I.R.C.)

- $R_4$ —50,000 ohms, 1-watt (I.R.C.).
- $R_5$ —3500 ohms, 50-watt (Ohmite).
- $R_6$ —10,000 ohms, 10-watt (I.R.C.).
- $R_7$ —10,000 ohms, 2-watt (I.R.C.).
- RFC—Sectional wound chokes (National R-100).
- $J_1, J_2, J_3, J_4$ —Closed-circuit jacks (Yaxley).
- S—Three-gang switch (Yaxley 1336), see text.
- $L_1, L_2, L_3$ —1.75 Mc.: 50 turns No. 22 d.s.c., close wound.
- 3.5 Mc.: 26 turns No. 18 enamelled, length 1 1/2 inches.
- 7 Mc.: 17 turns No. 18 enamelled, length 1 1/2 inches.
- 14 Mc.: 8 turns No. 18 enamelled, length 1 1/2 inches.

- 28 Mc.: 4 turns No. 18 enamelled, length 1 1/2 inches.
- All wound on Hammarlund SWF-4 coil forms (diameter 1 1/2 inches). On all except the 1.75-Mc. coil the turns are spaced evenly to fill the specified length.
- $L_4$ —1.75 to 3.5 Mc.: 36 turns No. 18 enamelled, close-wound.
- 3.5 to 7 Mc.: 16 turns No. 18 enamelled, length 1 inch.
- 7 to 14 Mc.: 8 turns No. 18 enamelled, length 1 inch.
- 14 to 28 Mc.: 4 turns No. 18 enamelled, length 1 inch.
- Links (number of turns to be determined by experiment) are wound over the plate coils at the cold end.

# What the League Is Doing

League Activities, Washington Notes, Board Actions—For Your Information

**Election Notice** To all members of the American Radio Relay League residing in the Dominion of Canada, Atlantic Division, Dakota Division, Delta Division, Midwest Division, Pacific Division, and Southeastern Division:

(Place and date)

*Executive Committee  
The American Radio Relay League  
West Hartford, Conn.*

Gentlemen:

*We, the undersigned members of the A.R.R.L. residing in the ..... Division (or in the Dominion of Canada), hereby nominate ..... of ..... as a candidate for director (or for alternate director, or for Canadian General Manager, or for alternate Canadian General Manager, as the case may be) from this region for the 1938-1939 term.*

(Signatures and addresses)

You are hereby notified that, in accordance with the constitution, an election is about to be held in each of the above-mentioned regions to elect both a member of the A.R.R.L. Board of Directors and an alternate thereto. In the case of the Dominion of Canada the election is to choose a Canadian General Manager and an alternate Canadian General Manager, for the 1938-1939 term. In the case of the United States divisions, the election is to choose a division director and an alternate division director for the 1938-1939 term. Your attention is invited to Sec. 1 of Article IV of the constitution, providing for the government of the A.R.R.L. by a Board of Directors; Sec. 2 of Article IV, and By-Law 12, defining their eligibility; By-Laws 13 to 23, providing for the nomination and election of division directors, and By-Law 14 providing for the simultaneous election of alternate division directors; By-Laws 27 to 34 providing for the nomination and election of a Canadian General Manager, and By-Law 28 providing for the simultaneous election of an alternate Canadian General Manager. Copy of the Constitution & By-Laws will be mailed any member upon request.

Voting will take place between November 1 and December 20, 1937, on ballots that will be mailed from the headquarters office in the first week of November. The ballots for each election will list, in one column, the names of all eligible candidates nominated for the office of director by A.R.R.L. members residing in that region; and, in another column, all those similarly named for the office of alternate. Each member will indicate his choice for each office.

Nomination is by petition. Nominating petitions are hereby solicited. Ten or more A.R.R.L. members residing in any one of the above-named regions may join in nominating any eligible member of the League residing in that region as a candidate for director therefrom, or as a candidate for alternate director therefrom. No person may simultaneously be a candidate for the offices of both director and alternate. A separate petition must be filed for the nomination of each candidate, whether for director or for alternate director. The following form for nomination is suggested:

The signers must be League members in good standing. The nominee must have been both a member of the League and a licensed radio amateur operator for a continuous term of at least four years preceding the receipt by the Secretary of his petition of nomination. He must be without commercial radio connections: he may not be commercially engaged in the manufacture, selling or renting of radio apparatus normally capable of being used in radio communication or experimentation, nor commercially engaged in the publication of radio literature intended, in whole or in part, for consumption by licensed radio amateurs. Further details concerning eligibility are given in By-Law 12. His complete name and address should be stated. All such petitions must be filed at the headquarters office of the League in West Hartford, Conn., by noon E.S.T. of the 1st day of November, 1937. There is no limit to the number of petitions that may be filed, but no member shall append his signature to more than one petition for the office of director and one petition for the office of alternate director. To be valid, a petition must have the signatures of at least ten members in good standing; that is to say, ten or more members must join in executing a single document; a candidate is not nominated by one petition bearing six signatures and another bearing four signatures. Petitioners are urged to have an ample number of signatures, since nominators are frequently found not to be members in good standing.

Present directors and alternates for these regions are as follows: Dominion of Canada, Canadian General Manager, Mr. Alex Reid, VE2BE, St. Lambert, P. Q.; alternate, none. Atlantic Division, Director, Mr. Walter Bradley Martin, W3QV, Roslyn, Pa.; alternate, none. Dakota Division, Director, Mr. Carl L. Jabs, W9BVH, St. Paul, Minn.; alternate, Mr. Fred

W. Young, W9MZN, Mankato, Minn. Delta Division, Director, Mr. E. Ray Arledge, W5SI, Pine Bluff, Ark.; alternate, none. Midwest Division, Director, Mr. Floyd E. Norwine, jr., W9EFC, St. Louis, Mo.; alternate, Mr. O. J. Spetter, W9FLG, Topeka, Kan. Pacific Division, Director, Mr. S. G. Culver, W6AN, Berkeley, Calif.; alternate, Mr. J. L. McCargar, W6EY, Oakland, Calif.; Southeastern Division, Director, Mr. Bennett R. Adams, jr., W4APU, Homewood, Ala.; alternate, Mr. S. J. Bayne, W4AAQ, Birmingham, Ala.

These elections constitute an important part of the machinery of self-government in A.R.R.L. They provide the constitutional opportunity for members to put the direction of their association in the hands of representatives of their own choice. Members are urged to take the initiative and file nominating petitions immediately.

For the Board of Directors:

K. B. WARNER,  
Secretary

July 31, 1937.

**30-Mc. 'Phone** Effective September 17th, the F.C.C. has widened and changed our 30-Mc. telephony assignment as requested by the A.R.R.L. Board of Directors, so that it is now 28,500 to 30,000 kc. instead of the former 28,000 to 29,000. The change was made by amending the figures in Rule 376 and a similar change is understood to have been made in Rule 403. Those of you who keep your copies of the Rules up-to-date should make these alterations.

And now to change over our 30-mc. rigs! Let all amateurs take note that there is to be no more telephony in this band between 28,000 and 28,500 kc. but that they may now go all the way to the 30-Mc. end of the band with voice. All of the band remains open to telegraphy.

**Financial Statement**

The League had a loss of a little over three thousand dollars in the second quarter of this year, before disbursements against special appropriations—an amount which is normal for that season of the year. By order of the Board, the operating statement is here published for the information of the membership:

**STATEMENT OF REVENUES AND EXPENSES, EXCLUSIVE OF EXPENDITURES CHARGED TO APPROPRIATIONS, FOR THE THREE MONTHS ENDED JUNE 30, 1937**

REVENUES	
Membership dues . . . . .	\$ 9,627.80
Advertising sales, <i>QST</i> . . . . .	23,004.53
Newsdealer sales, <i>QST</i> . . . . .	11,189.04
Handbook sales . . . . .	6,162.23
Booklet sales . . . . .	2,272.00
Calculator sales . . . . .	329.59
Membership supplies sales . . . . .	2,238.61
Interest earned . . . . .	408.86
Cash discounts received . . . . .	390.98
Bad debts recovered . . . . .	25.43
	<hr/>
	\$55,649.07

Deduct:	
Returns and allowances . . . . .	\$ 4,367.71
Collection and exchange . . . . .	6.11
Cash discounts allowed . . . . .	415.95
	<hr/>
	\$ 4,789.77
Less decrease in provision for newsdealer returns of <i>QST</i> . . . . .	348.47
	<hr/>
Net Revenues . . . . .	\$51,207.77
EXPENSES	
Publication expenses, <i>QST</i> . . . . .	\$15,982.32
Publication expenses, Handbook . . . . .	3,686.35
Publication expenses, booklets . . . . .	771.76
Publication expenses, calculators . . . . .	194.30
Membership supplies expenses . . . . .	1,246.89
Salaries . . . . .	22,642.89
<i>QST</i> forwarding expenses . . . . .	1,051.37
Office supplies and printing . . . . .	1,739.81
Postage . . . . .	1,903.27
Telephone and telegraph . . . . .	529.08
General expenses . . . . .	871.78
General Counsel expenses . . . . .	269.06
Insurance . . . . .	92.25
Rent, light and heat . . . . .	839.87
Travel expenses, business . . . . .	1,607.54
Travel expenses, contact . . . . .	577.20
Provision for depreciation of furniture and equipment . . . . .	325.55
Communications Dept. field expenses . . . . .	83.32
Headquarters station expenses . . . . .	7.48
Bad debts charged off . . . . .	11.15
	<hr/>
Total Expenses . . . . .	54,433.24
Net Loss before Expenditures against Appropriations . . . . .	\$ 3,225.47

**New Commissioners** Just before it adjourned in August, the Senate confirmed the appointment of two new commissioners to the F.C.C.:

Mr. Frank R. McNinch, chairman of the Federal Power Commission, is becoming the temporary chairman of the F.C.C. in the place left vacant by the recent death of Mr. Prall. Rated an exceptional executive, Mr. McNinch is simply taking a leave of absence from the F.P.C. to help straighten out the F.C.C. in some of its recent difficulties and is thereafter expected to return to his permanent post.

Lieutenant-Commander T. A. M. Craven, the past two years the chief engineer of F.C.C., was elevated to a commissionership to fill the vacancy left by the recent resignation of Dr. Stewart. Thoroughly qualified both as a radio engineer and as an administrator, this appointment has very general approval. Commander Craven has attended almost every radio conference in which the United States has participated since the war. He will be the logical choice to head the U. S. delegations to Habana and Cairo. As was reported in *QST* at the time, he was the chief negotiator of the high-frequency allocation system worked out at Washington in 1927 and which has since remained the basis for world allocation. "Tam" has A.R.R.L.'s hearty congratulations; he has been pretty thoroughly "exposed" to amateur radio.

(Continued on page 35)

# Modernizing the Simple Regenerative Receiver

## A Two-Tube Band-Switching Model of Proved Performance

By Vernon Chambers,\* W1JEQ

**A**N ATTEMPT to improve the operating convenience of the simple regenerative receiver has brought about the layout pictured and described. The main feature, band-switching, has neither greatly increased the cost nor complicated the construction. The simplicity of the circuit makes worthwhile the building of such a set even if it is to be used only as a spare or as the receiving section of an emergency or portable station. Indeed, even the budding ham's technical knowledge might well profit from the

that an attempt be made to follow the original set-up as closely as possible.

Before going into the actual description of the receiver may we have one more thought, addressed particularly to the beginner. The circuit, except for the band-switching details and the values of some of the components, is practically the same as the one described in the fifth edition of the A.R.R.L. booklet, *How to Become a Radio Amateur*. A splendid idea for anyone not too familiar with the practical fundamentals of radio is to study and understand the operation, both mechanically and electrically, of the mentioned receiver thoroughly. This done, he will find himself with a great deal of worthwhile information, useful when the construction of this modernized set is attempted.

The first step is to procure a panel and base. At the same time, since we have now entered the aluminum cutting end of the job, we may as well manufacture the two and only brackets needed.

The panel, measuring  $9\frac{3}{4}$  by  $\frac{1}{2}$  inches, is cut from a sheet of  $\frac{1}{16}$ -inch aluminum, as is also the base and one of the brackets. The base is started from a piece of stock 9 by 6 inches. A line, parallel and  $1\frac{1}{2}$  inches in from one of the 9-inch sides, is scratched with a sharp-pointed tool. With the  $1\frac{1}{2}$ -inch section bent down until it is at right angles with the  $4\frac{1}{2}$ -inch piece, we have a chassis 9 by  $\frac{1}{2}$  by  $1\frac{1}{2}$  inches. A 9-inch length of  $\frac{1}{2}$ -inch aluminum angle serves to fasten the base and panel together.

Next come the two brackets, one to support the band-setting condenser shaft and the other for the coil switch. These also may be made from  $\frac{1}{16}$ -inch aluminum; however, in the original job  $\frac{1}{8}$ -inch stock was used for the switch mount to assure extreme rigidity. If the condenser is mounted on one of the small pillars provided, its bracket will measure  $1\frac{1}{2}$  by  $1\frac{3}{4}$  inches in the upright position with an added  $\frac{1}{2}$ -inch lip for fastening to the base. A  $\frac{1}{4}$ -inch hole is then drilled in line with the condenser shaft to allow the passing through of the extension rod. The switch bracket measures 2 by 2 inches, with a  $\frac{3}{4}$ -inch lip which allows the use of four mounting screws to make a firm attachment to the base.

Compactness will require that the parts be set up as shown in the picture. A survey of the picture is also the easiest way to determine their

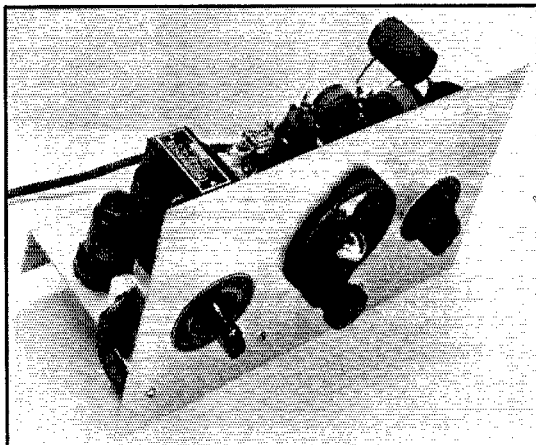

**IN THE MODERNIZED VERSION OF THE SIMPLE REGENERATIVE RECEIVER COIL SWITCHING ELIMINATES THE INCONVENIENCE OF PLUGGING IN COILS FOR CHANGING BANDS**

*On the front panel, the coil switch is to the right of the band-spread tuning dial in the center and the regeneration control is to the left. The band-set condenser control projects from the left side of the chassis.*

setting up of such a receiver, not only as a simple piece of equipment with which to experiment but also as a working model to demonstrate fundamental radio circuits.

The pentode detector and audio amplifier circuit employed is the same as that of many regenerative receivers with the exception of the coverage of four bands, 1.7 Mc. to 14 Mc., by means of the band-switching arrangement instead of by plug-in coils. Many days of considerable building and rebuilding were spent before the suitable tube line-up and switching system was found for even so simple a circuit, and for that very reason the recommendation is passed along

\* Laboratory Assistant.

location. But special care should be taken with the following items.

With the band-setting condenser mounted as shown, a considerable decrease in stray capacities results from the use of short leads. Elevating the 6K7 tube base above the chassis provides a much

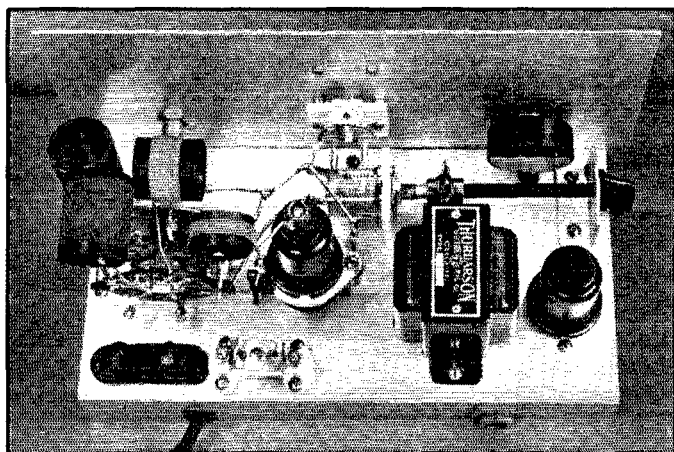

DETAILS OF THE COIL ASSEMBLY ARE SHOWN IN THIS REAR VIEW

shorter cathode connection—something of no small importance in this set. The switch is of the six-position type and, since there are only four coils, two sets of contacts are left unoccupied. To allow spacing of the 14- and 7-Mc. coils, the two with which coupling effects are most likely to cause trouble, one or even two of the spare contacts may well be left between their points. We then have the 14-Mc. coil at the left end of the switch, next to the tube, the extra contacts, and then the 7-, 3.5- and 1.7-Mc. coils mounted on the remaining three sets of points. A word of warning: Don't attempt to mount the coils at anything other than right angles with each other. Also try to separate them as much as possible, still keeping in mind the necessity of short leads. If these

precautions are taken, little or no trouble should arise to impair the proper functioning of the circuit.

The circuit, shown in Fig. 1, is of the pentode detector and one-stage audio amplifier type, employing two tubes, the 6K7 and the 6C5, both of which operate at a low current drain, making feasible battery operation. Coupling of the antenna to the cathode of the detector through the small variable condenser,  $C_1$ , proved to be the most satisfactory method. Although operation on any band with maximum capacity is permitted, adjustment of the condenser to match various antennas allows the circuit to be brought up to its most sensitive operating point. Screen voltage is varied by means of the potentiometer  $R_5$  to control regeneration, which is obtained by tapping of the cathode near the ground end of each detector coil. This tap should be placed so as to allow the tube to go into oscillation with about 30 volts applied to the screen grid. A second way to determine the correct placement of the tap is to select a position for the tap that will cause oscillation to occur when the control,  $R_5$ , is half turned on. These hints are given in case the coils are wound with wire different from that specified.

The r.f. choke in the plate output lead protects

(Continued on page 76)

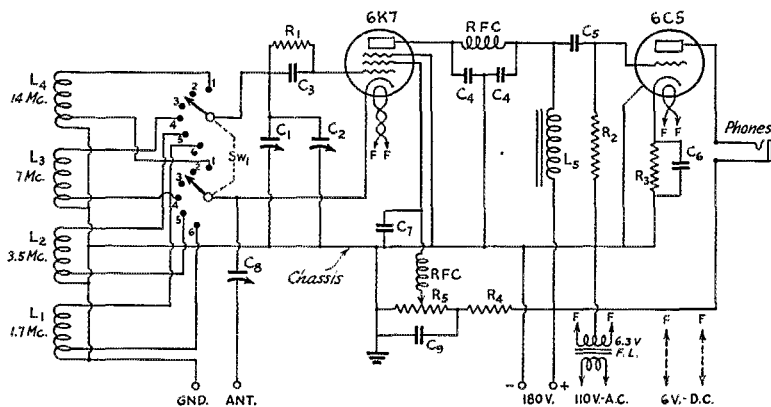

FIG. 1—CIRCUIT DIAGRAM OF THE COIL-SWITCHING RECEIVER

- $C_1$ —100- $\mu$ fd. variable (Hammarlund HF-100).
- $C_2$ —15- $\mu$ fd. variable (Hammarlund HF-15).
- $C_3$ ,  $C_4$ —100- $\mu$ fd. midget mica (receiving).
- $C_5$ —0.1- $\mu$ fd. 600-volt paper.
- $C_6$ —25- $\mu$ fd. 50-volt electrolytic.
- $C_7$ —0.001- $\mu$ fd. midget mica.
- $C_8$ —30- $\mu$ fd. padding condenser (National Type M 30).
- $C_9$ —2- $\mu$ fd. 200-volt electrolytic.

- $R_1$ —5-megohm  $\frac{1}{2}$ -watt resistor.
- $R_2$ —0.25-megohm 1-watt resistor.
- $R_3$ —5000-ohm 1-watt resistor.
- $R_4$ —50,000-ohm 20-watt.
- $R_5$ —50,000-ohm potentiometer (Electrad).
- SW1—6-position coil switch (Vaxley 152L).
- $L_5$ —A. f. choke (Thordarson No. 3736).
- RFC—2.5-millihenry r.f. chokes (National Type 100).



# Results, 1937 DX Competition

By E. L. Battey,\* WIUE

**T**HE final tally of scores in A.R.R.L.'s Ninth International DX Competition at long last completed, Tom York, W1JBJ, and Yours Truly are once more beginning to act like ordinary human beings. It's a relief not to dream of numbers every night!

What a contest it was! Unanimously voted the "best yet," the results bear out this fact. This year the contest was in two sections, the first (March 6th-14th) for C.W. participants, the second (March 20th-28th) for Voice operators. In the 1936 DX Contest Results we said of



© Signal Corps U. S. A.

**JAMES A. WILSON, EX-W2BXU, K5AY, WHO TOPPED THE WORLD WITH 253,635 POINTS—1618 QSO'S!**

*Receiver is rebuilt FBXA; Transmitter—59-'47-'46's-211, with 200 watts input.*

XE2N's score of 189,081 (1370 QSO's), "We believe XE2N has made a record that will stand for some time." Brothers, we spoke out of turn. Never again will we make predictions concerning DX contests! Read on.

That DX contests are fun all participants agree, but it sometimes seems that the real fun comes *after* the contest when you get together with the gang to compare notes. "Did you hear . . ."—"Say, where was . . . I heard you calling him"—"Just wait until next year!"—"What score did you make?"—and all the other questions (and answers that go with them) that follow a contest bring enjoyment equal to actual participation. We hope that the report here presented will bring back memories of your contest operation.

The official score list gives the accomplishments of 1391 C.W. operators (1024 W/VE, 367 in 61

\* Assistant Communications Manager.

outside localities) and 376 'Phone operators (241 W/VE, 135 in 45 outside localities). The results of the C.W. and 'Phone portions are tabulated separately since they were actually separate contests.

## THE WINNERS

The winners in the contest are the first-listed in each A.R.R.L. Section, and in each outside locality, both for the C.W. and 'Phone Section; 64 C.W. certificate awards and 59 'Phone awards are being made in the United States and Canada; 61 C.W. awards, 45 'Phone awards go to countries outside W/VE. Hearty congratulations to all winners!

Although, competitively speaking, there is no "national high" and no "world high," keen interest is always displayed in just which operators made the highest scores, which made the most QSO's, who worked the greatest number of countries, etc. Some of the "double-dyed-in-the-wool" DX-ers actually compete for highest place rather than for honors within their own Section or country. With these points in mind we have dug out some real eye-opening facts.

## The C.W. Section

**A**LTHOUGH an old name in DX circles, Ralph Thomas, W2UK, pulled sort of a "dark horse" stunt on us when he very quietly and

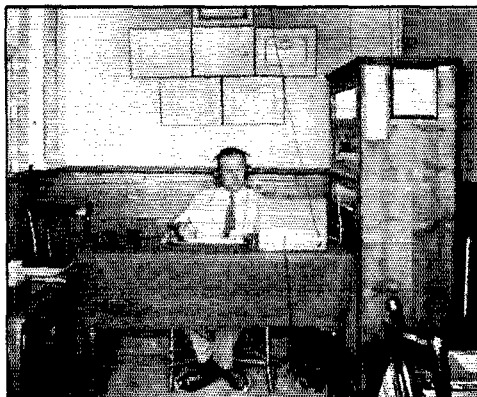

**FRANK H. PETTITT, SUISG, AT HIS OPERATING POSITION; TRANSMITTER IS BUILT IN LARGE CABINET AT HIS LEFT**

unassumingly, after we thought we knew the leading scores, came through with the highest score among W/VE's—119,796 points representing

268 QSO's, a multiplier of 149. Not content with breaking all DX Contest score records, W2UK worked 71 different countries, thereby establishing a new "countries worked" record for contests. He ran 1 KW. to a pair of '52's on 3.5, 7, 14 and 28 Mc., operating 87 hours, 52 minutes. Hamdom congratulates you, W2UK, on a real "hamfeat"!!

A healthy second is Clark Rodimon, W1SZ, with 116,070—265 QSO's, 68 different countries, a multiplier of 146. W1SZ ran about 650 watts input to a pair of 805's on 3.5, 7, 14 and 28 Mc. A veteran of DX Contests, "Roddy" says he "never had so much fun since . . ." It must be fun to be able to run up a score like that!

Rolling up the best DX contest record the West Coast has yet seen, Henry Sasaki, W6CXW, is right up at the top. . . . 266 QSO's, 67 different countries, multiplier 139, and a grand total that is GRAND—110,544! Your grandchildren should be proud of you, Henry! We salute you! W6CXW operated on 3.5, 7, 14 and 28 Mc. with 1 KW. input to P.P. 150T's.

Other outstanding scores that demand special attention follow. Good work, all: W2AIW 98,445; W6GRL 90,750; W4CBY 89,838; W9TB 76,160; W6FZL 72,189; W9ARL 71,008; W1TW 70,560 (2 oprs.; W1TW 50,000); W8FJN 69,328; W6JBO 69,300; W6GRX 64,746; W2JME 62,434; W8LEC 57,120; W4AH 57,018; VE2AX 56,341; W3PC 56,304; W2CBO 51,264; W1ME 51,156; W1DHE 51,102; W2GRG 50,934; W1TS 50,796.

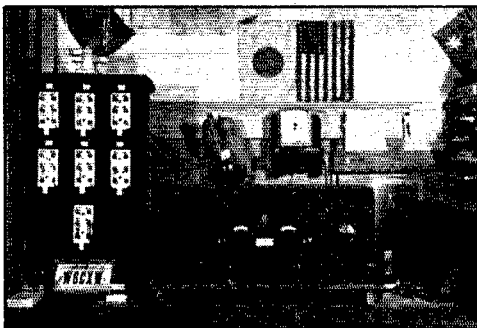

W6CXW OPERATING TABLE; CONTROL SWITCH AT RIGHT OF RECEIVER; FINGER-TIP SELECTION OF SIX DIFFERENT ANTENNAS IS POSSIBLE BY MEANS OF THE SWITCHBOARD AT THE LEFT

The highest scorer in each W district: W1SZ 116,070, W2UK 119,796, W3PC 56,304, W4CBY 89,838, W5VV 29,032, W6CXW 110,544, W7AMX 28,875; W8FJN 69,328; W9TB 76,160. The highest Canadian: VE2AX 56,341.

Leaders in number of QSO's are: W2UK 263; W6CXW 266; W1SZ 265; W2AIW 246; W6GRL 242; W4CBY 217; W9TB 216; W9ARL 212; W6JBO, W1TW (2 oprs.) 210; W6FZL, W8FJN 207; W2JME, W6GRX 198; W4AH 187; W3PC 184, VE2AX, W8LEC 182 and W1DHE 181. For a permissible 90 hours of operating (and some of these lads operated less than 90 hours!) these figures sure represent some fast work!

Those having the highest multipliers (total of different countries worked on each band used): W2UK 149; W1SZ 146; W6CXW 139; W4CBY 138; W2AIW 135; W6GRL 125; W9TB 119; W6FZL 117; W8FJN, W9ARL, W1TW (2 oprs.) 112; W6JBO 110; W6GRX 109; W2JME 106; W8LEC 105, VE2AX 103 and W1DHE, W1TS, W3PC, W4AH 102.

#### HIGH FOREIGN SCORES

The W/VE contingent extends sincere thanks to the operators in localities outside the U. S. and Canada for making contest enjoyment possible. Were it not for the whole-hearted cooperation of you fellows in getting into the fracas and working us W's and VE's we wouldn't have any contest.

The chap who dispelled our illusions that XE2N in the 1936 contest had reached the top in scores was James Wilson, K5AY, who made 1618 QSO's (about 18 QSO's per hour!), a multiplier of 53 and a final score of 253,635!! Dwell on that a while. It's an example of top operating performance, if ever there was one. Mister Wilson, take a bow! Four bands (3.5, 7, 14, 28) were utilized, good antennas and 200 watts input. An interesting sidelight is that K5AY is located in the jungles at Chiva Chiva, C. Z.

A good second high world scorer is Juan Lobo y Lobo, XE2N, who smashed his '36 record by totalling 206,415 points. Highest scorer in the '36 contest (189,081), use of an additional frequency band and a higher multiplier (55) brought him more points this year. In 84 hours, 15 minutes of operating, XE2N made 1270 QSO's on the 1.7-,

3.5-, 7-, 14- and 28-Mc. bands using an input of 150 watts.

In third and fourth places respectively we find K6CGK 163,600, and K7PQ, 162,968. K6CGK made 1110 QSO's and a multiplier of 50, K7PQ made 1058 QSO's, a multiplier of 52. K7PQ used 5 bands, 350/600 watts, K6CGK 4 bands, 90 watts. It was a close race between these fellows.

Next in line, and excellent scores too, come:

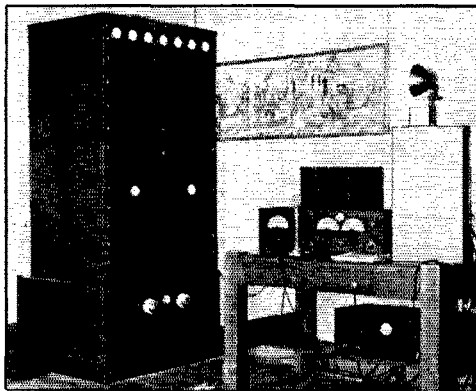

THE LAYOUT AT W9ARA, HIGHEST W/VE SCORER IN THE 'PHONE SECTION OF THE CONTEST—A SMOOTH-LOOKING STATION THAT REALLY PERFORMS

F8EO 151,650; K5AC 129,792; ZL4AO 103,800; K6ILT 102,949; FM8AD 94,176; D4XCG 92,389; PA0AZ 90,235; G6NF 79,289; G16TK 78,081; YM4AA 75,600; VK3MR 74,702; G2PL 73,968; OA4J 72,590; K6JPD 71,586; OE3AH 71,552 and YR5AA 70,584.

The highest scorer on each continent: Africa—ZS2A 57,240; Asia—J4CT 8352; Europe—F8EO 151,650; North America—K5AY 253,635; Oceania—K6CGK 163,600; South America—OA4J 72,590.

QSO champions are: K5AY 1618 contacts; XE2N 1270; K6CGK 1110; K7PQ 1058; F8EO 1021; K5AC 905; ZL4AO 876; D4XCG 836; PA0AZ 774; OA4J 727; K6ILT 711; YR5AA 707; YM4AA 700; FM8AD 654; PA0UN 648; VK3MR 642; PAOPN 613; VK3CP 603; YR5CF 590; OK2OP 571, G6NF 565, and OE3AH 558.

The highest multiplier was made by XE2N, who worked 13 W/VE districts on 7 Mc., 13 on 14 Mc., 12 on 3.5 Mc., 10 on 28 Mc., and 7 on 1.7 Mc. for a total of 55. K5AY made a multiplier of 53, followed by K7PQ 52, G16TK 51, K6CGK F8EO 50, K6ILT 49, FM8AD K5AC 48, G6NF 47, G2PL 46, EI8B K6JPD GM5YG 45, G6LK OE3AH 43, PA0QQ 42, EI4J G6WY 41, G2ZQ SM7UC ZL4AO 40.

#### GENERAL ITEMS

W1BB, W6GRX, VE1EA, G2PL, K7PQ and XE2N were the only operators to make use of 5

frequency bands . . . 4-band operation was commonplace. . . . These contests provide excellent memory training in trying to keep track of the stations already worked. . . . K6CGK made 21 contacts the first hour of the battle. . . . Incidentally, CGK claims the longest contest log in the world; his C.W. log measured 21 feet, his 'phone log 5 feet, making a total of 26 feet, all in one piece! . . . Typical success story: After trying off and on since 1910, W3BEN completed W.A.C. in 4 hours, 19 minutes during the contest. . . . The "Sunday Drivers" of amateur radio, the inveterate "testers," came in for their share of cussing. . . . One out of every five stations worked by G6RB was a W9. . . . W2AIW guesses the guy with the eighteen pencils on the cover of March QST must have run up a whopping score—he used but one pencil and a sharpener and got 98,445! . . . W9AFN heard 84 different countries. . . . It was amusing to hear some operators bemoan the lack of DX while their own signals were QRMing more DX than could be worked in a week. . . . W5OXO's first QSO was with G6RB—a nice job of following the sample log in February QST. . . . W8FJN made W.A.C. six times, once in 4½ hours. . . . W5CPT was right there with his low power—with 8 watts input he made W.A.C. twice during the contest. . . . W9DGL in Nebraska heard and called 67 different countries. . . . W3GEA's sunshine was turned to rain when after calling SUICH for nearly an hour he came back to



W9TB, ILLINOIS WINNER AND SEVENTH HIGH AMONG W/VE PARTICIPANTS IN THE C.W. PORTION OF THE CONTEST

Transmitter line-up: 59-three '47 doublers-302-P.P. RK-20's-four 860's P.P.-Par. final, 1-KW. input, 'phone or C.W., all bands, 3.5 through 28 Mc. Interesting features of the station are temperature-controlled crystal oven with eleven 3.5-Mc. crystals with selector switch, elaborate standard frequency apparatus consisting of 100-ke. crystal in temperature-controlled oven, buffer and multiplier with harmonic selector on the panel, and seven separate antennas, one for 3.5, two each for 7, 14 and 28 Mc.

W3G-E—B! . . . K7PQ worked W6GRX on 5 bands. . . . VE1EA worked G2PL on 5 bands in a little over 16 hours. . . . XE2N QSO'd W4AUU on 5 bands in one day. . . . W8EMW heard about 80 different countries on 7 and 14

(Continued on page 80)

# Concentrated Directional Antennas for Transmission and Reception

## Rotatable Loops and Antenna-Reflector Systems of Reduced Dimensions

ALL the "angles" pertaining to directional antenna systems are not just those we usually talk about. Besides angle of concentration in the vertical or horizontal plane, angle of rotation, angle of the wires, there is also the all-important "angle" of, "how much space?" Rhombics and multiple arrays of conventional form give high gains—but even for the 14-Mc. band they take considerably more yardage than most of us have available. Therefore, concentrated directional systems which are more readily fitted into the usual back yard have a distinct appeal from the space "angle". While they may not give such tremendous power gains, as compared to a simple half-wave dipole, they can give front-to-back ratios which noticeably improve the signal-interference ratio for the owner in reception and for the other fellow in transmission. By forming half-wave units into different shapes, thereby reducing the over-all dimensions, John Reinartz has achieved several different types of compact directional systems. In the following articles, W1QP outlines the electrical design and performance of half-wave loops, and Dr. Simpson describes the folded-end antenna-reflector system constructed for his station on suggestions from W1QP.

### Half-Wave Loop Antennas

By John L. Reinartz,\* W1QP

AN UNUSUAL type of loop antenna for both transmitting and receiving has been in use at W1QP for some time and has been found particularly useful on the higher frequencies. At  $2\frac{1}{2}$ , 5, 10 and 20 meters, this antenna has shown itself well suited for amateur use, especially where room is at a premium. Even attic space is sufficient for its erection. When mounted out of doors, it compares very favorably with the usual type of half-wave "straight" antenna in all respects and has the advantages of a high degree of directivity and polarization sensibility. An additional advantage is that this antenna can be used for direction finding. Feeding the antenna is no

problem because feeder radiation or pickup is negligibly small and because symmetrical loading of the feeder line is accomplished as a matter of

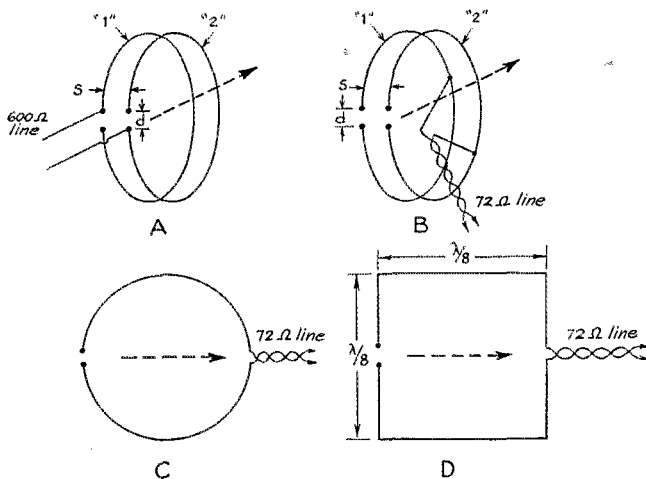

FIG. 1—DOUBLE-CIRCLE, SINGLE-CIRCLE AND SQUARE HALF-WAVE LOOPS WITH DIFFERENT FEEDER CONNECTIONS

The spacings "d" and "s" are described in the text. The arrows indicate the direction of maximum concentration in transmission.

course. Because the antenna is simple, construction difficulties do not present themselves in any marked degree and are not beyond the facilities of the amateur. In its simplest form, the antenna can be erected in less than 30 minutes.

The basic idea of the antenna centers about a half-wave length antenna conductor, preferably of aluminum or copper tubing, bent into a circle. In its preferred form, as shown in Fig. 1A, the antenna is made up of two such circles spaced a few inches apart by means of supports of insulating material (which may be wood that has been soaked in oil or paraffin). Of course the circles do not quite close since that would short-circuit the antenna and render it useless. The recommended opening in the circle,  $d$ , is 0.2 inch per meter; thus for 20 meters, the opening is 4 inches. The recommended spacing between the two circles,  $s$ , is 1 inch per meter; for 20 meters, the spacing is 20 inches. The circles are so mounted that the openings coincide. Because the antenna has a directional front-to-back ratio which in practice

\* 176 Wadsworth St., South Manchester, Conn.

amounts to a power ratio of 4 or approximately 6 db, it is important to be able to change the direction in which the antenna points. A gain in signal is obtained in the direction of the current loop side of the antenna; a reduction in signal is

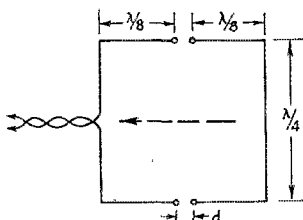

FIG. 2—THE SQUARE RADIATOR-REFLECTOR SYSTEM IS MADE COMPACT BY BENDING THE END EIGHTH-WAVE SECTIONS OF THE WIRES, MAKING THE DIMENSIONS A QUARTER-WAVE ON EACH SIDE

experienced in the direction of the voltage loop or open ends. This statement holds good for both reception and transmission. Therefore, when the antenna is mounted in a vertical plane, for rotation about a line in the plane of the loop, the open end is placed at "3 o'clock" or at "9 o'clock". When the antenna is mounted in a horizontal plane, the direction of transmission and reception is given by an arrow starting from the open end and drawn across the middle or current loop. The field strength gain in the forward direction, it should be mentioned, is about 28% as compared to a straight half-wave dipole.

The feeders can be connected to the antenna in a number of ways, the best way depending on the type of feeder. The spaced type of feeder is recommended for 28 Mc. and higher frequencies in order that the transmission losses may be kept at a minimum. For 14 Mc. it is perfectly feasible to use any of the good low-impedance or 72-ohm lines that are on the market. When a tuned, spaced line is used, the connections are to opposite ends of the circles,

one on the Number 1 and the other on Number 2 circle, across the diagonal. This means that each feeder is symmetrically loaded to the antenna, a condition which is hard to obtain with a normal end-fed half-wave antenna, such as a Zepp.

When a low-impedance, or 72-ohm, feeder line is used, it is connected in a similar manner but at the current loop, one feeder wire going to one circle a little off from the middle of the antenna and the other feeder going to the other circle a little off from the middle of the antenna in the opposite direction. The optimum distance between the connection of the feeders and halfway point on the antenna depends on the impedance value of the feeders and may be from 0.1 inch per meter to 0.5 inch per meter of the fundamental wavelength. The optimum distance can be determined by the fact that the load drawn by the antenna is greatest when the feeders are connected at the optimum distance. Another indication of proper adjustment is that, with this adjustment, no change in tuning results when the antenna coupling is removed.

A modification of the double-circle loop antenna consists of but one circle or one square, mounted either vertically or horizontally, as shown in Figs. 1C and 1D. Again, a half-wave length of wire is formed into a square, and is left open by the amount,  $d$ , previously mentioned.

Then the point opposite the opening is cut and a 72-ohm feeder line is connected into this cut, exactly as would be done in the case of a center-fed half-wave antenna. The difference between the square or circular antenna and the center-fed half-wave straight antenna is that the square or circular antenna is unidirectional rather than bidirectional. Both the square and circular antenna will give remarkable results, even when mounted in an attic. Both of them are easily made steerable. The circular antenna can be mounted in a horizontal plane and suspended with waxed string from the attic rafters. With this arrangement, the

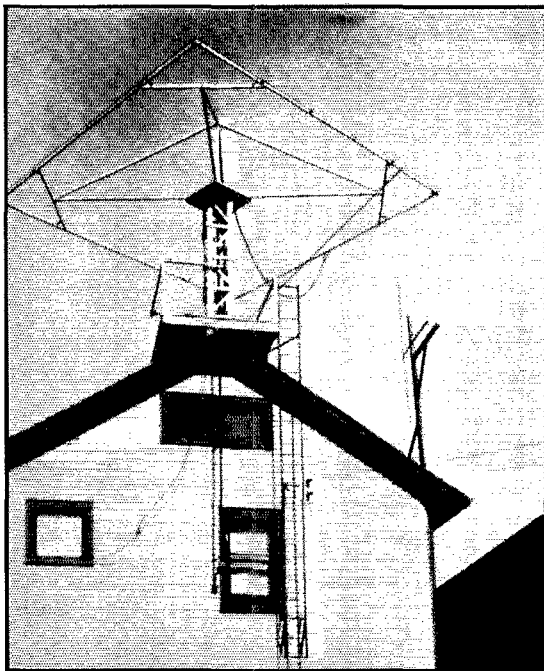

THE QUARTER-WAVE SQUARE "SIGNAL SQUIRTER" AT W8CPC

It is rotatable to all points of the compass by gearing to a directionally calibrated control wheel in the operating room.

antenna can be pointed in any desired direction. The square antenna can be constructed with an insulator inserted in the middle of each side of the square. With this arrangement, the antenna can be aimed, electrically, in any one of four directions by shorting out two opposite insulators.

The feeder also may be a single wire connected half-way between the open end and the current loop. This feeder gives the same general results as those obtained with the spaced feeders and the 72-ohm line.

Some confusion may result when it is found that the receiving station obtains the best signal from the direction opposite to that in which the antenna is pointing. This is one of the phenomena apparently due to the polarization effects of the antenna. When mounted in a vertical position the antenna transmits a vertically polarized wave, and receives best a wave which is vertically polarized. When the antenna is mounted in a horizontal plane, the transmitted signal is horizontally polarized and a signal horizontally polarized is received with maximum strength. When the directivity of the antenna appears to be changed 180 degrees from the normal position, it is found that the transmitting station antenna is radiating a vertically polarized wave. The question of whether the antenna should be mounted with the plane of the loop vertical or horizontal is determined by the transmission requirements and the frequency to be used.

## A Square "Signal Squirrel" for 14 Mc.

By Burton T. Simpson,\*\* W8PCP

THE idea for this antenna was suggested by John Reinartz. Upon the theory that the radiation from a half-wave antenna comes largely from the middle quarter-wave portion, it is argued that not much energy should be wasted by turning back each end. By doing this much space would be saved. To make the radiation unidirectional, a reflector was constructed on the same principle, thus forming a square. The schematic of this antenna system is given

\*\*108 Homer Ave., Buffalo, N. Y.

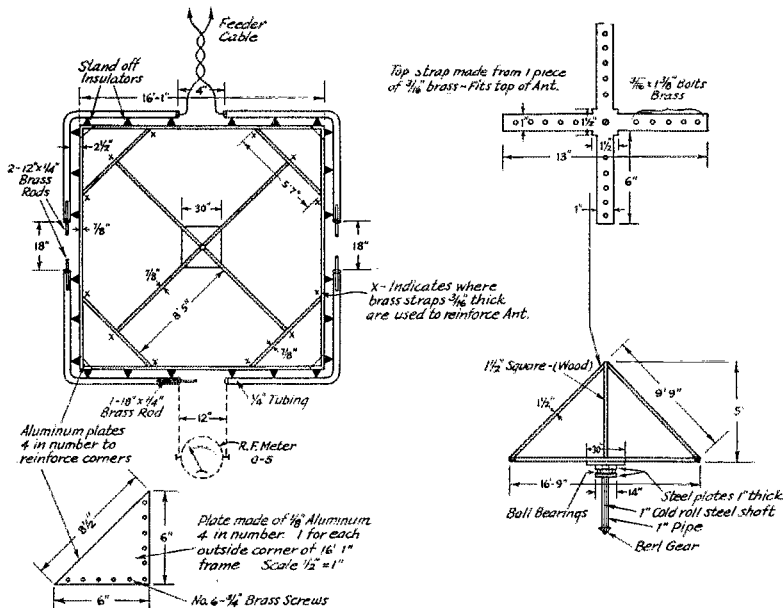

FIG. 3—CONSTRUCTIONAL DETAILS OF THE ANTENNA ASSEMBLY AT W8PCP

The diameter of the copper tubing is drawn to enlarged scale for clarity.

in Fig. 2, while constructional details are suggested in Figs. 3 and 4.

To form the frame, four lengths of fir wood, the type of wood used in making ladders, 16 feet 1 inch long by 1 1/2 by 1 1/8 inches, were formed into a square. A center block 30 inches square by 1 1/8 inches thick is placed in the center. Across the corners are braces of the same material. From the corner braces to the center block are four more braces from the same material. In the center of the block a post 5 feet long by 1 1/2 inches square is erected and four braces from the top of this to the corner braces are placed. You now have the main structure for the antenna which is 16 feet 1 inch square.

Four lengths of copper tubing 15 feet by 1/4 inch are used for the antenna radiator and reflector. Starting at the radiator side, two stand off insulators 2 1/2 inches long are placed exactly 4 inches apart. The ends of the 2 pieces of copper tubing are flattened and a hole placed in them to fit over the 2 insulators. From these ends Bassett cable is fastened and runs to the tank coil of the transmitter where it is link-coupled. Insulators are placed at intervals along the front and sides to accommodate the rest of the copper tubing. However, at the side ends the copper tubing must not be flattened because the final tuning is done by the insertion of brass rods in the open ends. It will be found that about 7 feet will be turned on each end. Turning the ends of the tubing

shortens the calculated length of the antenna. This one happens to be 31 feet long.

Beginning at the reflector side of the antenna, two stand-off insulators are placed about 12 inches apart and the other two lengths of copper

is connected by short leads, and the Bassett cable link is inserted in the center of the tank coil of the transmitter. The transmitter is now turned on and the brass rods in the ends of the copper tubing are pushed in or out until the highest reading of final amplifier plate current is obtained. Then the brass rods in the ends of the reflector are manipulated for the highest reading in the r.f. meter. This will cause the final amplifier milliammeter to read lower. Again tune the antenna for highest final input, which will cause a decrease in the reflector r.f. reading. Retune the reflector in the same manner for maximum reading of the r.f. meter. This is repeated until both meters give the highest reading. Now tape the brass rods at the sides, remove the r.f. meter and close the reflector gap with its brass rod, tape it—and the job is completed.

At W8CPC this antenna works very well. In a typical instance, with the "squitter" pointed toward England, G5ML gave an "S9 +" report. With the antenna pointed in the opposite direction, he gave "S2". By using a relay in the cable circuit this antenna also acts as an excellent receiving antenna with quick change-over.

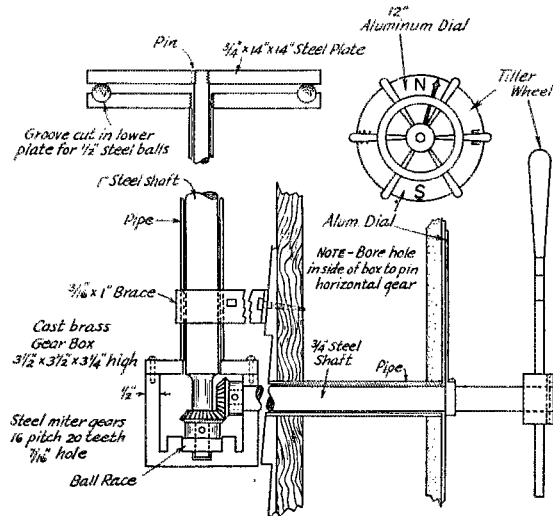

FIG. 4—DETAILS OF THE MECHANICAL SYSTEM USED TO ROTATE THE W8CPC ANTENNA

tubing are fastened to these by a strap. Then, with the required number of stand-off insulators, this is extended the length of the back and bent forward at the corners. With the exception of the 2 front portions which constitute the center of the antenna, the rest of the copper tubing must be fastened to the stand-off insulators by straps. It is important to have the distance between the antenna and reflector exactly 16 feet 6 inches.

It is necessary to have 5 lengths of brass rod to fit snugly into the copper tubing for tuning purposes. Four are inserted in the tubing on the sides; the fifth must be longer than the others to close the gap in the reflector after the meter inserted for tuning is removed.

Underneath the center square wooden block is a steel plate 14 inches square by 1 inch thick. This is bolted to the block of wood and has a groove for ball bearings. At the center of this is screwed a 1-inch steel rod to rotate the antenna. The steel plate fits exactly on the top of a similar steel block fastened to a 7-foot tower which rests on a platform built on the top of the house. The bottom of the steel rod fits in a gear box which is connected to a similar steel rod entering the radio room. On the end of this is a wheel backed by a brass plate showing the points of the compass. Details of the mechanism are given in Fig. 4.

#### TUNING UP PROCEDURE

In the open space in the reflector the r.f. meter

### More on PITC

ABOUT the only thing that will stop a landslide is another landslide. We have reference to the announcement on page 56 of the September issue of *QST* wherein it was stated that steps were being taken by A.R.R.L. to arrange a fund for providing modern radio gear for remote Pitcairn Island. This resulted from the considerable number of unsolicited contributions received from readers of the original PITC article in the August issue.

But it seems that not only did individual readers have this idea—a group of manufacturers did, likewise. These manufacturers went ahead and lined up a complete station layout, including a Wincharger for charging the storage battery which was to serve as the primary power basis. In view of this effort, which by the time we learned of it had already progressed to a point where it could not readily be recalled, A.R.R.L. is abandoning its plans, has returned the contributions.

Right now we don't know just what the outcome will be. The islanders have as yet had no opportunity to express themselves on the subject. We don't know what their desires are; it may be that they want only 600-meter stuff, or it may be that Andrew Young can be persuaded to turn ham. We don't even know what the British government will have to say about it. But these things will be determined, and the story will, we hope, eventually be told in *QST*. Until then, thanks, gang! Your hearts are in the right place!



# Negative-Peak Automatic Modulation Control for Plate-Modulated 'Phone Transmitters

IF EVERY one of our 'phone transmitters could be made over-modulation proof, that greatest affliction to amateur 'phone communication would be remedied forthwith. For, despite the constant campaign against over-modulation and the government regulations against it, there is still altogether too much "side-band splatter" and other evidence of the spurious resulting from pushing the modulation level beyond the permissible limit. It is realized that instances of exceeding the transmitter's modulation capability are mostly unintentional. Voice level and speaker's position with reference to the microphone can't be kept rigidly fixed. What is needed is automatic "means to insure," built right into the transmitter, which is practically fool-proof. Such means we now have at hand. Previous articles<sup>1</sup> have described speech-amplifier compression circuits. The contributions of Messrs. Plummer and Waller presented here-with describe how to employ the modulator itself as the control agency. Although similar, the systems described were worked out independently by the two authors and are printed in the order received, W2CMI's first and W2BRO's second. Since these systems not only give automatic over-modulation insurance but also provide volume compression, higher average percentage modulation increases the effective signal and gives the operator a considerable extra dividend on his investment.

## Over-Modulation Control and Volume Compression with Variable-Mu Speech Amplifier

By W. Bradley Plummer,\* W2CMI

IN KEEPING with the rapid advances that have been taking place recently in the design and control of amateur equipment, it seems fitting that automatic volume control circuits

\* Department of Electrical Engineering, Iowa State College, Ames, Iowa.

<sup>1</sup> W. B. Smith "Volume-Compressing Method," *QST*, Sept., 1936; R. E. Bullock and H. N. Jacobs, "Electronic Volume Compressor," *QST*, Sept., 1937; J. Hanson, "A.V.C.-Controlled Pre-Amplifier," *QST*, Sept., 1937.

should be incorporated in modern 'phone transmitters. The advantages to be obtained include the maintenance of high modulation level, the elimination of obnoxious overmodulation and relief from the troublesome necessity of adjusting the voice to the microphone or the amplifier gain

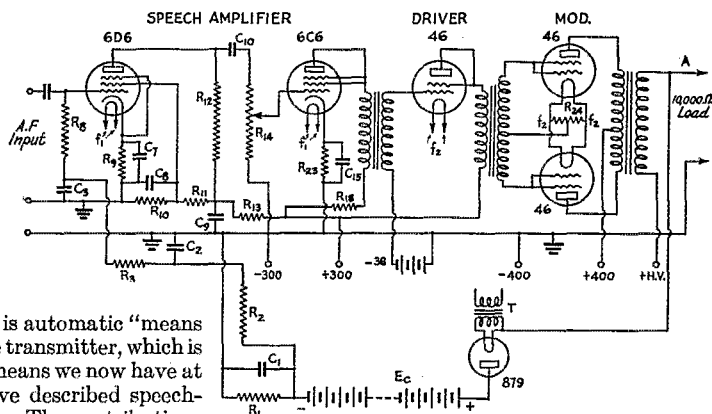

FIG. 1—CIRCUIT ILLUSTRATING THE OPERATION OF THE AUTOMATIC CONTROL  
Component values are given with Fig. 2.

to the voice as must now be done in order to obtain uniform performance. Volume compressing methods<sup>1</sup> which have been described previously are capable of accomplishing these objectives, but the circuit arrangement treated here has the advantages of requiring no audio coupling transformers, of being largely self-adjusting and, in addition, of providing attenuation to the amplification of the audio signal only after a high modulation level has been reached. A high audio surge will cause the a.v.c. action to take effect almost immediately, and this effect will then persist for as long as several seconds, if desired, permitting the speaker time to take a breath without a great change in amplifier gain.

The control voltage is applied to the grid of a variable-mu screen-grid tube in exactly the way that it is done conventionally in receivers; when the grid bias is increased negatively, the overall gain of the stage is decreased, accomplishing the desired control. The novel feature of the circuit is the method used to obtain this controlling voltage. Fig. 1 shows the experimental circuit which was used, while Fig. 2 shows a practical circuit incorporating the same features applied to a typical higher-power line-up.

The functioning of this circuit is based upon

the fact that the instantaneous potential applied to the plate circuit of the modulated stage of a transmitter should never become negative, for if it does the sudden interruption of plate current sets up transient signals which largely account for the "splashing over" which is characteristic of over-modulation. It is desired, then, to have the a.v.c. take control before the potential at point

obtained as soon as the potential at "A" becomes some pre-determined low value. This is accomplished by connecting a source of d.c. voltage to the plate of the control rectifier making its plate positive relative to ground. Now as soon as the potential at "A" becomes less positive than the rectifier plate, current will begin to flow in the tube, since its filament is negative relative to its

plate. This current causes a voltage drop in  $R_1$  which is carried to the control grid of the variable-mu amplifier tube, the 6D6 in this case, causing a reduction in gain of the amplifier.

In order to avoid audio feedback, this control voltage must be adequately filtered, which is done in the usual manner by use of resistances and condensers, as shown. The main filter condenser  $C_1$  must be large, for it must smooth out the sudden voltage surges to which it is sub-

jected by virtue of the fact that current flows through the rectifier only during a very small part of any audio cycle. It will be noted that the a.v.c. voltage is available only after sufficient time has passed for  $C_1$  to charge through the rectifier. Since the circuit through which this charging current flows has low resistance, only a fraction of a second is required. But the discharge of  $C_1$  occurs slowly, the current flowing entirely through  $R_1$  or through the condenser itself as normal leakage. Thus, a delay of a few seconds or more may be obtained by choosing the proper value for  $R_1$ .

It was found desirable to operate the controlled tube at a relatively high audio level—not as the first tube following a low-level microphone, for example. The reason for this is that less trouble from audio feedback through the control circuit is then experienced, so that  $R_2$  and  $R_3$  may be made smaller, reducing the time required for the a.v.c. to take effect. It was also found that the 6D6 was unusually sensitive to stray electromagnetic fields, but this undesirable pick-up is negligible when the tube operates at high signal levels.

The performance of this circuit is entirely satisfactory not only from the consideration of the constancy of output voltage with varying input signal voltages, but also when its freedom from distortion is considered. By use of an oscilloscope, with constant input wave form the output wave form was seen

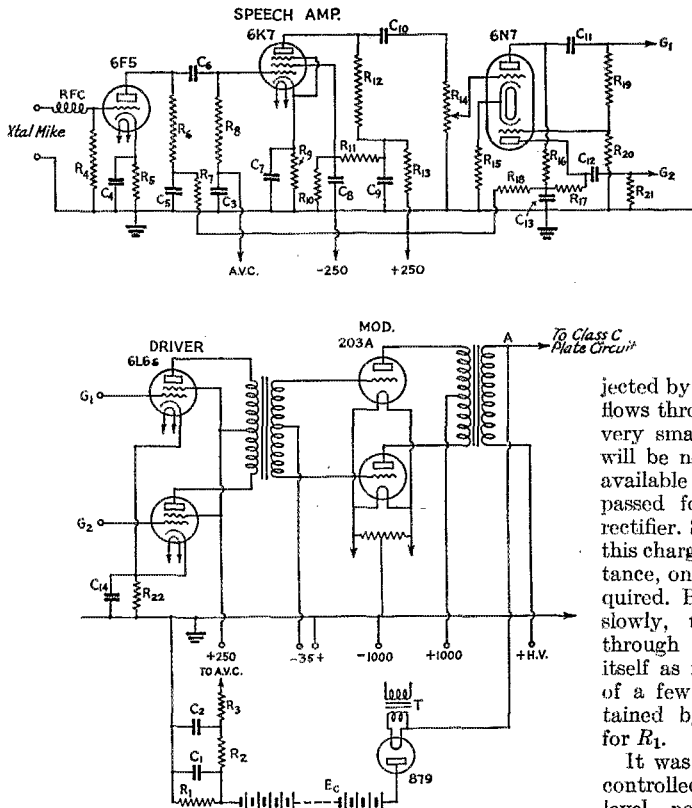

FIG. 2—THE AUTOMATIC CONTROL CIRCUIT APPLIED TO A HIGHER-POWERED MODULATOR UNIT

Values given also apply to the circuit of Fig. 1.  
 $C_1, C_5$ —8- $\mu$ fd. electrolytic.  
 $C_2$ —0.01- $\mu$ fd.  
 $C_3$ —0.05- $\mu$ fd.  
 $C_4, C_7, C_{15}$ —10- $\mu$ fd. 25-v. electrolytic.  
 $C_6, C_8, C_{10}, C_{11}, C_{12}$ —0.1- $\mu$ fd.  
 $C_9, C_{13}$ —0.5- $\mu$ fd.  
 $C_{14}$ —10- $\mu$ fd. 50-v. (optional).  
 $R_1$ —500,000 ohms (or less).  
 $R_2$ —2-megohm or less (sometimes zero).  
 $R_3, R_{11}, R_{12}$ —100,000-ohm.  
 $R_4$ —5-megohm.  
 $R_5$ —2600-ohm.

$R_6, R_{16}, R_{17}$ —250,000-ohm.  
 $R_7, R_{10}$ —50,000-ohm.  
 $R_8, R_{21}$ —500,000-ohm.  
 $R_9$ —2000-ohm.  
 $R_{12}$ —20,000-ohm.  
 $R_{14}$ —500,000-ohm variable.  
 $R_{15}$ —3000-ohm.  
 $R_{18}$ —10,000-ohm.  
 $R_{19}$ —481,500-ohm.  
 $R_{20}$ —18,500-ohm.  
 $R_{22}$ —125-ohm.  
 $R_{23}$ —1000-ohm.  
 $R_{24}$ —20-ohm.  
 $T$ —2.5-v. filament transformer, high-voltage insulation.  
 $Ec$ —90 v. (when h.v. = 700).

"A", Fig. 1, can become zero at the instant during an audio cycle when the audio voltage opposes the applied voltage most strongly. In practice it is necessary that control voltage be

to remain unaltered when the input voltage was varied throughout a range of 20 to 1. During this variation the output voltage varied only about ten percent. A variation of 40 to 1 in input voltage varied the output voltage about twenty per cent. This represents a change in amplifier gain of more than 30 db, which should be adequate for ordinary amateur uses. Fig. 3 gives a graphical picture of the relation of output voltage to input voltage.

Another characteristic of the circuit which

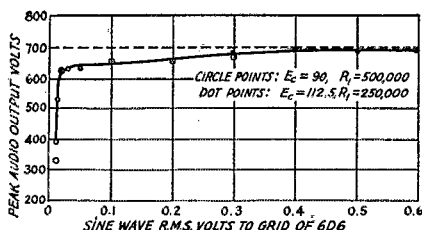

FIG. 3—ILLUSTRATING THE CONTROL CHARACTERISTICS OF THE SYSTEM

would be of particular value in case it were desired to operate with reduced power is illustrated in Fig. 3. In consequence of the means by which the control voltage is obtained, the audio output of the modulator automatically adjusts itself to variations in d.c. voltage applied to the modulated stage.

Extensive laboratory tests of this circuit have been made using both microphone and phonograph pickup as well as the test signals used to obtain data for the curves. The quality of both speech and music was found to be unimpaired when the input signal level was varied over a wide range. That instantaneous overmodulation can occur if a sudden loud impulse is applied to the amplifier is recognized, but it can exist only during a fraction of a second, reducing the resulting interference to a minimum. The values given for  $E_c$ ,  $C_1$ ,  $R_1$ ,  $R_2$  and  $R_3$  are not at all critical, and may well be modified to suit individual situations. An alteration in the detail of the audio rectifier circuit could adapt this scheme readily to public address systems.

## Negative-Peak Control with 6L7 Speech Amplifier and All-A.C. Operation

By L. C. Waller,\*\* W2BRO

EVERY experienced 'phone operator knows how much disturbance an over-modulated carrier can cause in our over-crowded 'phone bands. Such a signal frequently renders an entire 'phone band practically useless to those unfortunate amateurs who happen to be located near the

offending station. It may even cause bad interference to stations at a great distance, under certain conditions. Of course, it is illegal to over-modulate a 'phone transmitter, or to modulate one "in excess of its modulation capability"; but nevertheless many stations do not have modulation-monitoring apparatus which is adequate for the purpose.

It is difficult, by ordinary means, to prevent some over-modulation, even when a cathode-ray oscilloscope is available for monitoring purposes. If the gain control is set so that practically no modulation peaks "overshoot," then the average modulation is certain to be quite low. In addition, two persons seldom speak at exactly the same sound level, and one person does not always speak at the same level. The distance of the speaker from the microphone is still another important variable factor.

With these thoughts in mind, the writer set about to see what could be done along the line of automatic modulation control, or modulation limiting. With a.v.c. circuits as applied to r.f. stages as a guide, it seemed natural to consider some sort of audio a.v.c. wherein the over-all gain of the speech amplifier is automatically controlled. Of equal importance is the source of controlling voltage.

The control voltage should preferably come from the modulator itself or from the modulated r.f. carrier, rather than from the speech amplifier. Such things as carrier shift due to d.c. plate voltage changes and audio voltage variations due to modulation transformer frequency characteristics should have no effect on the modulation-control system. In addition, the system should operate on the *negative* modulation peaks, rather than on the positive peaks, because it is excessive negative peaks which cause carrier cut-off and a broad, side-splattering signal.

A basic system which seems to meet all these requirements is shown in Fig. 4. A 6L7 is used as the control tube in the familiar volume-expander circuit (circuit No. 10 in the RC-13 Receiving-Tube Manual), working "backward" as a volume contractor. The No. 3 grid normally operates at  $-2\frac{1}{2}$  volts, at which bias the gain of the stage is quite high, the mutual conductance of the 6L7 being in the order of 1200 micromhos. When the negative bias on the No. 3 grid is increased to about  $-10$  volts, the mutual conductance and gain of the tube are reduced to very low values.

The negative automatic-modulation-control (a.m.c.) voltage is obtained from the output of modulation transformer  $T_1$  through a half-wave, *high-vacuum* rectifier. A Type 836 is shown in the diagram, although almost any high-vacuum tube can be used provided it has a rating high enough to withstand the peak inverse voltage applied. When the *negative* a.f. peaks at point "X" on  $T_1$  exceed  $-1160$  volts (that is,  $1250-90$ , the 90 volts being an "advance" bias from  $B_1$ ), the rec-

\*\* RCA Radiotron Div., RCA Mfg. Co., Harrison, N. J.

tifier passes current, developing a d.c. voltage drop across  $R_1$ . The rectifier arrangement is similar to the negative-peak over-modulation indicator described previously in *QST*.<sup>2</sup> The d.c. voltage from  $R_1$  is fed through an r.f. and a.f. filter to the No. 3 grid of the 6L7 as an a.m.c. bias. In the example shown, whenever the negative modulation peaks exceed 93 per cent modulation (1160/

volts on the voltage divider. This would place a no-signal bias of  $-10$  volts on the No. 3 grid also, except that  $7\frac{1}{2}$  volts are bucked out by battery  $B_2$ . Thus, the desired no-signal bias of  $-2\frac{1}{2}$  volts is actually applied to the No. 3 grid. The a.f. signal applied to the No. 1 grid, from microphone transformer  $T_2$ , should have a peak value not exceeding one volt; larger values may cause a.f. distortion.

No wave-form distortion is caused by the action of the a.m.c. voltage, because it serves only to reduce the over-all gain of the entire speech system. The excessive a.f. peaks are not merely lopped off, but are suitably reduced, along with peaks of lesser amplitude. The volume control  $R_4$  can be adjusted over a fairly

wide range and the modulation still be kept within proper limits. If the operator speaks very low, or at a considerable distance from the microphone, the carrier can still be completely modulated if  $R_4$  is properly set initially.

The writer tested this a.m.c. circuit with a cathode-ray oscilloscope, using a modulated-envelope type of pattern. Control  $R_4$  was set so that, without a.m.c., a low whistle caused heavy over-modulation and carrier cut-off on the negative peaks. With the a.m.c. connected, and  $R_4$  in the same position, a loud whistle produced no over-modulation—just a perfect pattern. The loud signal, if made very suddenly, allowed a few peaks to over-shoot; however, the oscilloscopic pattern “sprang”

back to a perfect picture so rapidly that the eye could hardly detect the flaw, and the ear (with a receiving monitor) not at all.

Tests made with a number of other stations on 14-Mc. 'phone showed the modulated carrier to be very clean and sharp, without a trace of “side-splatter.” In addition, the signal seemed to have an unusual tendency to penetrate QRM. This was not expected originally, but on analysis it apparently results from the fact that the average modulation percentage is held at a considerably higher level with a.m.c. than without it. Low-level sounds and syllables that ordinarily would cause little modulation of the carrier can be boosted considerably because of the higher-than-normal setting of the main gain control. Then, when the higher-amplitude signals come along, they are automatically limited in their effect on the carrier.

#### AN “ALL-A.C.” CIRCUIT

The battery circuit of Fig. 4 has one serious disadvantage. The advance-bias battery  $B_1$

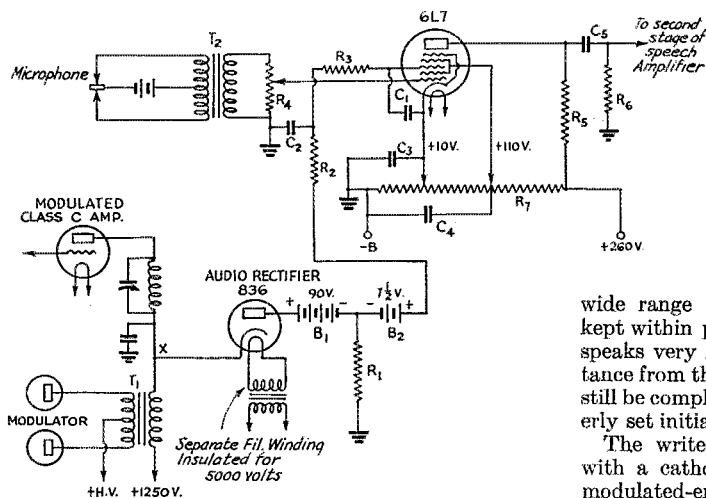

FIG. 4—SIMPLE AUTOMATIC MODULATION CONTROL CIRCUIT

Transmitter ground and a.f. amplifier ground must be connected together.

- |  |                                    |
|--|------------------------------------|
| $C_1$ —2.0- $\mu$ fd. 250-volt paper.      | $R_2$ —0.1-megohm 1-watt.          |
| $C_2$ —0.01- $\mu$ fd. mica.               | $R_3$ —1.0-megohm 1-watt.          |
| $C_3$ —25- $\mu$ fd. 25-volt electrolytic. | $R_4$ —0.5-megohm potentiometer.   |
| $C_4$ —8- $\mu$ fd. 250-volt electrolytic. | $R_5$ —0.1-megohm 1-watt.          |
| $C_5$ —0.05- $\mu$ fd. tubular.            | $R_6$ —0.5-megohm 1-watt.          |
| $R_1$ —0.5-megohm 1-watt.                  | $R_7$ —25-watt 20,000-ohm bleeder. |

1250), the gain of the 6L7 is reduced rapidly, the speed depending on the time constant of  $R_2$ ,  $R_3$  and  $C_1$ , the latter being an a.f. by-pass condenser. Thus, the a.m.c. bias starts to “take hold” a little before the carrier is over-modulated. If the time constant of the circuit is made too long, quite a few a.f. peaks may cause over-modulation before the gain is reduced, especially on a loud, sudden signal. If the constant is too short, trouble from “motor-boating” may be experienced, due to phase shift in the a.f. amplifier. The percentage of modulation at which the a.m.c. begins to act can be controlled by changing the value of the “advance” bias from  $B_1$ . It is very important that r.f. voltage be kept out of the 6L7 stage. The a.m.c. bias lead from the audio rectifier should be carefully shielded, and should include adequate r.f. filters.

The No. 1 grid of the 6L7 is biased to about  $-10$  volts, the cathode being tapped at  $+10$

<sup>2</sup> H. E. Seyse, “Over-modulation Indicator,” p. 49, *QST*, March, 1933; L. C. Waller, “Applications of the ‘Magic Eye,’” *QST*, Nov., 1936.

causes the a.f. by-pass condenser  $C_1$  to charge up to almost the full voltage of  $B_1$ , as the result of the rectifying action of the 836 and the Class-C amplifier tube when the plate voltage is removed from the latter during stand-by periods. Thus, when the carrier is placed on the air after a stand-by, either  $C_1$  must be shorted temporarily to dissipate the charge, or the speech system is effectively cut off until the charge leaks off through  $R_1$ ,  $R_2$ , and  $R_3$ . To avoid this trouble and to eliminate the batteries, the circuit of Fig. 5 is suggested.

In Fig. 5, the proper voltages for the 6L7 and the advance bias for the rectifier are all obtained from the voltage divider which supplies the d.c. voltages for the speech amplifier. With this arrangement, it is necessary that the power pack deliver 250 volts for the 6L7 plus 90 volts for the advance bias, because the cathode of the 6L7 is tapped in at +90 volts above ground. Thus, the advance bias for the a.m.c. rectifier is supplied by the bleeder, and the charging of  $C_1$  is eliminated. In the example shown, the power pack voltage is 340 volts, or 250 + 90. If the modulated Class-C amplifier happens to be operating at 2500 volts, an advance bias of about 180 volts may be required, and a power pack voltage of 430 volts. In general, an advance bias of about 7 per cent of the final amplifier's d.c. plate voltage will be found suitable. This circuit, being all-a.c. operated, is the one recommended for general use.

The use of a.m.c. on amateur 'phone transmitters, with a properly-designed and adjusted circuit, should effectively remove all the problems which have for so long been caused by over-modulated carriers. If put to general use, the practical effect of a.m.c. will be effectively to widen our 'phone bands. In due time, no doubt the use of some such automatic modulation control may even become mandatory. In any event, the operator of a 'phone transmitter employing a.m.c. will not have to watch continually his modulation monitor or be forever adjusting the speech gain control.

## Southwestern Division Convention

Tempe, Arizona, October 23rd and 24th

YES, the Southwestern Division Convention for 1937 is to be held in Arizona under the auspices of the Tempe Amateur Radio Associa-

tion. All the activities will take place at the State Theatre, which is owned and operated by "Red" Harkins, W6BUQ, and who is also the Chairman of the Convention Committee. Put the dates down—Saturday and Sunday, October 23rd and

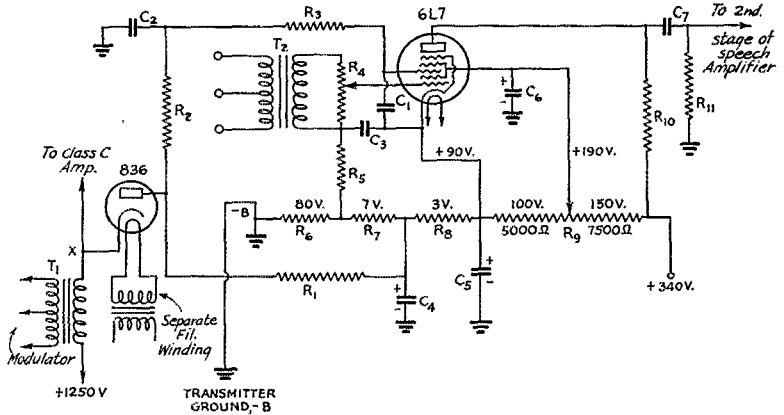

FIG. 5—THE ALL A.C.-OPERATED A.M.C. CIRCUIT

$C_1$ ,  $C_2$ —Same as in Fig. 1.

$C_3$ —0.5- $\mu$ f. paper.

$C_4$ ,  $C_5$ ,  $C_6$ —8- $\mu$ f. electrolytics.

$C_7$ —0.05- $\mu$ f.

$R_1$ ,  $R_2$ ,  $R_3$ ,  $R_4$ —Same as in Fig. 1.

$R_5$ —0.5-megohm  $\frac{1}{2}$ -watt.

$R_6$ —4000-ohm 5-watt.

$R_7$ —350-ohm 1-watt.

$R_8$ —150-ohm 1-watt.

$R_9$ —12,500-ohm 25-watt bleeder, tapped as shown.

$R_{10}$ —0.1-megohm 1-watt.

$R_{11}$ —0.5-megohm 1-watt.

24th, respectively. A good program is in progress of preparation at the time of writing this announcement and further information may be obtained from "Red" Harkins, W6BUQ, care of State Theatre, Tempe, Arizona.

## What the League Is Doing

(Continued from page 21)

Further important promotions in the Engineering Department are now to be expected, which we shall duly report.

### Membership Committee

It will be remembered that the Board appointed a committee to work for increased A.R.R.L. membership and for methods of making membership more attractive, etc. This Board's Committee, consisting of Messrs. Martin (chairman), Blalack and Norwine, has been actively at work. They are approaching the S.C.M.'s and clubs for suggestions, they are running some advertisements in *QST*, and they have prepared a large circular on the advantages of A.R.R.L. membership which is being handed out at the door at conventions and hamfests this autumn. Watch for it and read it. It of course will probably be winter before the Committee is really down to bedrock in the intricacies of its studies.

# A Versatile Emergency Transmitter

By Walter J. Stiles, Jr.,\* W8DPY

**A**S YOU may have gathered from the title, this transmitter is a bit of emergency apparatus. It had its birth shortly after the flood emergency in northern Pennsylvania in March, 1936, and has now passed its first year of service with very satisfactory results.

Now let us assume that during a period of operation in the field we should have the misfortune to drop and break one of our 6L6G tubes. Under such circumstances we merely have to throw switch  $SW_1$  to position "A", place one of the remaining good tubes in the oscillator socket

and we are again on the air with a good 25-watt signal. Now assume our crystal feels in the mood to leave and divides itself into several parts for one reason or another; we merely reach into a pocket and produce grid-coil  $L_1$ , place same in crystal socket, load oscillator tube to approximately 15 watts output—and there we are back again in the fight. There are many other ways in which we could get output, but it is very seldom that more trouble than that just mentioned would be experienced.

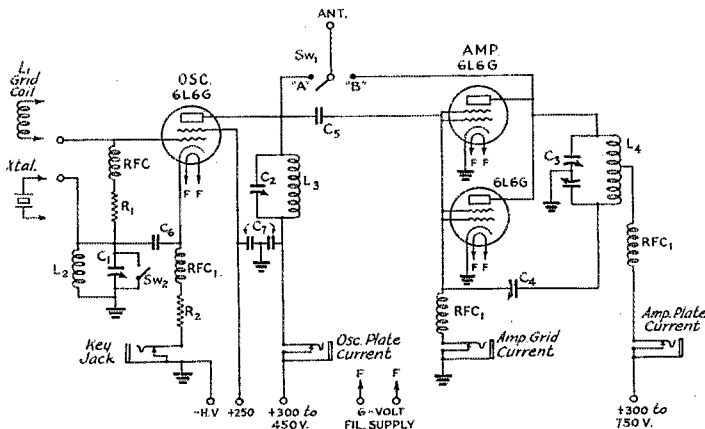

FIG. 1—CIRCUIT OF THE EMERGENCY TRANSMITTER WHICH CAN MAINTAIN SERVICE AS LONG AS A SINGLE TUBE REMAINS

$L_1, L_2, L_3$ —Grid, cathode and plate coils of conventional sizes to suit frequency of operation. See A.R.R.L. Handbook.  
 $C_1$ —150- $\mu$ fd. midget variable (Tri-tet cathode tuning condenser).  
 $C_2$ —150- $\mu$ fd. midget variable (Oscillator plate tank condenser).  
 $C_3$ —200- $\mu$ fd. per section double midget variable (Amp. plate tank).

$C_4$ —50- $\mu$ fd. midget variable (Amp. neutralizing).  
 $C_5$ —50- $\mu$ fd. fixed mica (Amp. coupling condenser).  
 $C_6$ —0.01- $\mu$ d. paper by-pass.  
 $C_7$ —0.002- $\mu$ d. paper or mica by-passes.  
 $R_1$ —3000-ohm 1-watt grid leak.  
 $R_2$ —500-ohm 10-watt cathode resistor.  
 RFC $_1$ —2.5-millihenry r.f. chokes.

The circuit is designed to function in any one of three different manners. This allows for certain pieces of equipment to become inoperative during an emergency when no replacements are available and still operation can continue. To clarify this further let us look at Fig. 1. We find here a 6L6G tube used as a cathode-biased oscillator working either straight through ( $SW_2$  closed), or as a Tri-tet with its output on the second harmonic ( $SW_2$  open). This is followed by a pair of 6L6G tubes in a Class-C amplifier. The latter is so designed, by tying the grids together, that it operates with zero bias. This allows the oscillator to be keyed and perfect break-in operation is had even with spot-frequency work. If you have ever sat before a transmitter in a real emergency you can readily appreciate good break-in operation.

In this emergency set, inputs with all apparatus in the circuit runs about 40 watts with a 300-volt motor-generator and about 110 watts with 750 volts on the plates. The voltage on the oscillator runs about 300 in the first and 450 in the latter case. Outputs are approximately 30 and 75 watts respectively.

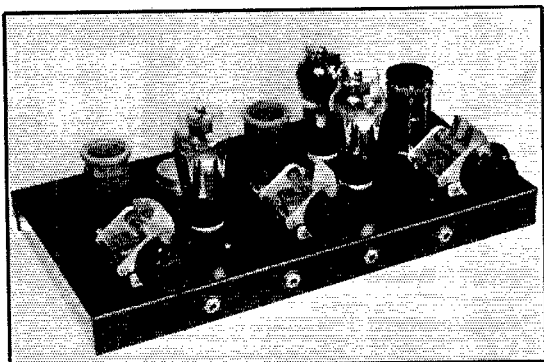

R.F. SUB-PANEL COMPLETE WITH THE OSCILLATOR GRID COIL IN PLACE

Jacks shown are oscillator current, keying, amplifier grid current and amplifier plate current.

\* Room 501, Pennsylvania Station, Pennsylvania Railroad, Philadelphia, Pa.

The construction of this transmitter in the metal case shown in the picture should not be considered the ultimate ideal for a perfect set-up. It was built in this manner merely because the case was on hand and because it fits very nicely into the water-proof box I have for my emergency gear. However, it does make a solid set-up and with a heavy power pack mounted in the bottom it just won't bound off the table every time you hit the key. Further, the metal type construction adds to the ease with which the 6L6G tubes can be neutralized. As a matter of interest, it is not possible to make the amplifier "sing" regardless of the setting of the neutralizing condenser.

#### TUNING

Tuning the rig up is really a pleasure. The use of cathode bias and zero bias tubes takes all the quick motions out of the procedure. You never have to jump from control to control to save a tube or two because they just won't draw excessive current. The mils on the oscillator hang around 40 when not oscillating and only go to 55 or 65 when in proper tune. The amplifier plate current drops to a mil or two with no excitation and only  $4\frac{1}{2}$  volts of "C" are necessary to effect complete cut-off. Crystal current does not make the filament of a 60-ma. bulb red, even when the full 750 volts are applied to the plate. As a matter of fact a test was made to see just how much a 6L6G will put out before it goes out, and at a plate voltage of 750 with 80 mils (60 watts) the tube keyed perfectly with a bug running at 40 w.p.m.

The old story of short leads and good connections is, as always, a very important one. It seems that about half of the trouble amateurs have with their equipment is the result of one or both of these defects.

### Strays

Those to whom the matter of base losses is of some concern will be interested to know that the 6L6G type tube is available from Raytheon with a standard 6-prong Isolantite base. Except for the base, the tube is interchangeable with other 6L6G types. The tube is designated the RK-49.

— — — —

The offices of F.C.C.'s 10th Inspection District at Dallas, Texas, are now located in Room 302, United States Terminal Annex Building, Houston and Jackson streets.

— — — —

1st Ham: "I understand you have an X license."

2d Ham: "Yeah!"

1st ditto: "Peachy, how'd you wangle it?"

2d ditto: "Easy. Out of the band 3 times, 3 pink slips and one EX call."

## A.R.R.L. QSL Bureau

FOR the convenience of its members, the League maintains a QSL-card forwarding system which operates through volunteer "District QSL Managers" in each of the nine United States and five Canadian districts. In order to secure such foreign cards as may be received for you, send your district manager a standard No. 8 stamped envelope. If you have reason to expect a considerable number of cards, put on an extra stamp so that it has a total of six-cents postage. Your own name and address go in the customary place on the face, and *your station call should be printed prominently in the upper left-hand corner.*

W1—J. T. Steiger, W1BGY, 35 Call Street, Willimansett, Mass.

W2—H. W. Yahnel, W2SN, Lake Ave., Helmetta, N. J.

W3—R. E. Macomber, W3CZE, 418 10th St., N. W., Washington, D. C.

W4—B. W. Benning, W4CBY, 520 Whiteford Ave., Atlanta, Ga.

W5—E. H. Treadaway, W5DKR, 2749 Myrtle St., New Orleans, La.

W6—D. Cason Mast, W6KHV, 423 East E St., Ontario, Calif.

W7—Frank E. Pratt, W7DXZ, 5023 So. Ferry St., Tacoma, Wash.

W8—F. W. Allen, W8GER, 324 Richmond Ave., Dayton, Ohio.

W9—Roy W. McCarty, W9KA, 11 South Michigan Ave., Villa Park, Ill.

VE1—J. E. Roue, VE1FB, 84 Spring Garden Rd., Halifax, N. S.

VE2—C. W. Skarstedt, VE2DR, 236 Elm Ave., Westmount, P. Q.

VE3—Bert Knowles, VE3QB, Lanark, Ont.

VE4—George Behrends, VE4RO, 186 Oakdean Blvd., St. James, Winnipeg, Manitoba.

VE5—E. H. Cooper, VE5EC, 2024 Carnarvon St., Victoria, B. C.

K4—F. McCown, K4RJ, Family Court 7, San-turce, Puerto Rico.

K5—John J. Carr, K5AV, 78th Pursuit Squadron, Albrook Field, Canal Zone.

K6—James F. Pa., K6LBH, 1416D Lunalilo St., Honolulu, T. H.

K7—Leo E. Osterman, K7ENA, Customhouse, Wrangell, Alaska.

KA—George L. Rickard, KA1GR, P. O. Box 849, Manila, P. I.

## Schedules for WWV

FOR transmissions and schedules of standard time intervals and ionosphere bulletins see "WWV Services Again Expanded," June, 1937, QST.

Each Tuesday, Wednesday and Friday (except legal holidays), the National Bureau of Standards station WWV will transmit on three frequencies as follows: 10:00 to 11:30 A.M., E.S.T., 500 kc., noon to 1:30 P.M., E.S.T., 10,000 kc., 2:00 to 3:30 P.M., E.S.T., 20,000 kc.

# How Would You Do It?

## Keeping Relays Quiet: Announcing the New Problem

**O**UR Hero is not very happy about the solutions to the 8th problem. It seems that the problem is actually a very tough one. Many of the solutions received are solutions in one sense of the word, but they are all either a bit weak in the knees or so close an approach to impracticability as not to matter much.

Anyway, first prize goes to W8OMM for a swell drawing and description of a double-box of sound-proofing material all dolled up with no less than 12 feed-through insulators. It is undeniable that some such sound-proof box is a perfectly good solution. The only snag is that it makes the whole affair rather cumbersome and makes it very difficult to perform adjustments on the relay. But it is the most sensible approach to date. We do not reproduce W8OMM's drawing because the idea can be conveyed very simply in words. There is just a small box in which the relay reposes and through the walls of which three pairs of feed-through insulators are inserted. The outer box, somewhat larger than the inner one, has its lower portion filled with absorbent cotton and it is on this that the inner box rests. Fairly flexible wires connect the terminals of the inner box to the terminals of feed-through insulators on the outer box. In the original design, one pair of insulators is on each side of the box, the other on top. There are fifty dozen different sets of sound-proofing "boards" available. Choose one that is tough enough to be sawn fairly clean and suitable for a quick assembly with nailed joints.

W1ALJ gets second prize for his excellent description and sketch of a sponge-rubber mounting for the relay. He suggests purchasing at the 5 & 10 store a sponge-rubber kneeling pad  $\frac{3}{8}$  or  $\frac{3}{4}$  inch thick (depending upon the weight of the relay). The relay is then mounted in the center of a strip of this rubber and a strip is stretched between two blocks at the end of a small baseboard. W1ALJ suggests that holes should be pushed through the rubber with an ice pick, this being preferable to screwing the screws through the rubber. He also suggests that any clanking due to a movable pole piece striking a stationary member of the core may be silenced by connecting a thin piece of felt or rubber to one of the metal faces concerned. He further suggests that should the rubber business fail to effect a complete cure the whole affair could be put in a box built of Celotex.

Other suggestions included the use of pools of mercury for the contacts—a scheme that we have tried on many occasions but have turned down because of the difficulty in getting metal for the contacts which does not soon amalgamate with the mercury. Others suggested the elimina-

tion of the relay and the connection of the receiving antenna to a node on the transmitter antenna coil. This scheme is not effective if the transmitter frequency is juggled much and, furthermore, makes a very poor receiving antenna out of a good transmitting antenna because the receiver is hitched at a point where minimum signals always should be available.

We still need the design of a quiet relay.

And again the contest rules:

1. Solutions must be mailed to reach West Hartford before the 20th of the publication month of the issue in which the problem has appeared. (For instance, solutions of problem given in the March issue must arrive at *QST* before March 20th.) They must be addressed to the Problem Contest Editor, *QST*, West Hartford, Conn.

2. Manuscripts must not be longer than 1000 words, written in ink or typewritten, with double spacing, on one side of the sheet. Diagrams and sketches may be in pencil, must be neat.

3. All solutions submitted become the property of *QST*, available for publication in the magazine.

4. The editors of *QST* will serve as judges. Their decision will be final.

(Continued on page 116)

### Problem No. 10

**O**UR Hero is still in difficulties. He is determined to make a thoroughgoing job of the lead-ins to the station (which, by the way, is getting pretty fancy these days). At the moment, he has a board under the lower sash of the window but the joints leak and some very chill breezes will be blowing through the gaps and through the space between the sashes unless something is done about it before the winter. Some sort of packing could be provided, but this introduces difficulties when the window has to be opened to get at the grounding switch. O. H. feels that there must be some refreshingly new angle on this lead-in business and needs a complete description of something really snooty. It has to provide him with some sort of grounding arrangement—something that will keep the underwriters happy. He is in hopes that the new scheme will eliminate the complication of installing a storm window, but if the worst comes to the worst, he will leave the storm window off and let the family continue to complain. (He pays the oil bill.)





# Amateur Radio STATIONS



## W2CSY, Riverhead, N. Y.

ANOTHER case of the motorman going out for a trolley ride is that of Murray G. Crosby, who spends his working time researching and designing in the Receiver Laboratories of R.C.A. Communications, Inc., at Riverhead, Long Island, and operates amateur radio station W2CSY as his hobby.

Murray's amateur experience dates back to the 200-meter days and his first station license

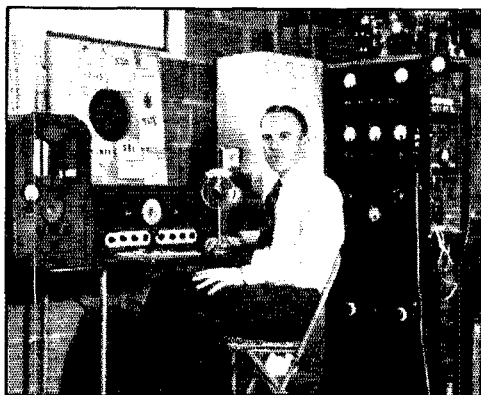

W2CSY

was 9AOX. This early experience was all with the key, but the present major use of W2CSY is with 'phone operation, although brass is pounded occasionally. The main reason for the 'phone is the fact that Murray's brother, Harry, operates 'phone station W9FDI out in the home town, Elroy, Wisconsin. This allows Murray to keep in constant touch with his folks and to talk with any member of the family. To do this, schedules are kept two or three times a week and it is only under severe conditions that contact is lost.

The transmitter at W2CSY is entirely home-made. RK-28's in push-pull are used in the final stage and are modulated at low-level with about 300 watts input. All types of low-level modulation have been tried including suppressor-grid, control-grid and linear-amplifier, and at present the final stage is acting as a linear to amplify

the suppressor-grid modulated output of an 802 doubler acting as an exciter. Inverse feedback is applied to improve the linearity and a cathode-ray oscilloscope (home-made) is employed to observe the quality of the transmitter output. A 59 crystal oscillator excites the 802 exciter through a 46 frequency doubler.

Two types of receivers are in use at present, a Radiola AVR-1 all-wave receiver which is shown to the left in the photo and an ACR-175 which is in the middle of the receiving table. To the right of the ACR-175 is the cathode-ray oscilloscope. The loud speaker is mounted in a baffle which is decorated with QSL cards. The "stand-by" position of the switch on the ACR-175 is arranged to operate a relay which turns on the transmitter while simultaneously turning off the receiver so that fast break-in operation may be accomplished.

The transmitting antenna is a one-wavelength "V" for 14,175 kilocycles, which is the most-used frequency. The receiving antenna is an inverted "V." Both antennas have their main directivity lobe aimed at Elroy, Wisconsin.

## W8QAN, Pittsburgh, Pa.

CONCRETE evidence of one most positive fact — "once a ham always a ham."

Amateur radio activities of W. K. Thomas, W8QAN, started in 1908 with self-assigned "DGM." In late 1912 he held the call 8DE and was the proud possessor of the station shown in one of the photographs—the button-top shoe and

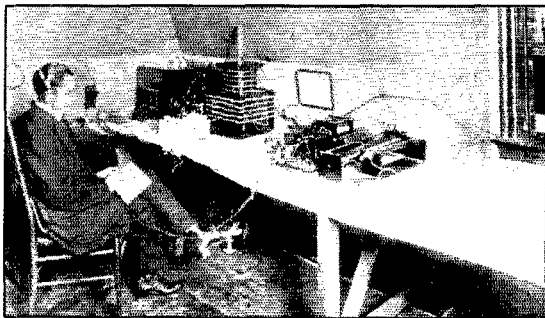

BEFORE . . .

and linseed oil-splattered wall affair. Any old timer will recognize the equipment used in those days.

Enlistment during the World War stopped his amateur activities but immediately upon return home the call 8LF was assigned and was in active service up to about five years ago. At that time Thomas *thought* he was through—sold out and allowed his call to expire.

The other photograph proves the original statement to be true.

Since the late photograph was taken a few changes have been made but the three racks are still in service. The left-hand rig is used exclusively for ORS work at 600 watts input and for

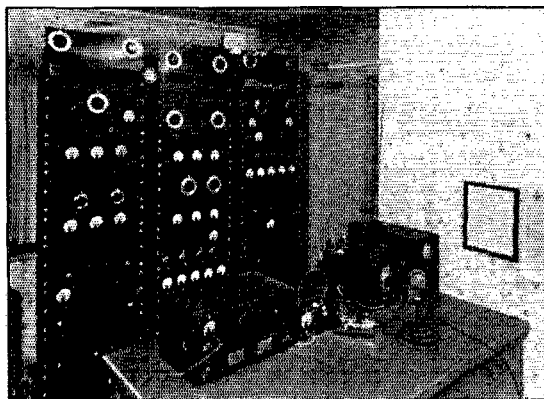

... AFTER, W8QAN

OPS work at 450 watts input. It consists of an 89 keyed oscillator, RK-25, RK-20 and a pair of 805's in the final. The center rack is used on 20 and 10 meters, both c.w. and 'phone, and consists of an 89 oscillator, RK-25 buffer-doubler, RK-20 second buffer, and a pair of 100TH's, with 1 kw. available for c.w. Separate power supplies are used for both rigs.

The right-hand panel now holds complete audio-frequency equipment, speech-amplifier and modulators (838's). An RCA cathode-ray oscilloscope has taken the place of the old exciter-final.

The antenna change-over switch mounted on the horizontal wood bar is simply the mechanical contacts of a d.p.s.t. relay mounted in an open-ended Vietron box. To keep a.c. away from the antenna leads the magnet part of the relay is behind the desk with "string" control attached to the magnet arm and guided to the movable contacts by round wooden knobs.

Desk layout: HRO receiver, field meter and 'phone monitor, frequency meter-monitor and crystal mike.

The equipment just described is a far cry from 1912 yet both most completely accomplished the purpose for which they were designed. And the operator still contends, "once a ham, always a ham."

## The Cover

A GOODLY percentage of the Headquarters gang have been spending their Sunday mornings recently trying their hand at flying Ross Hull's radio-controlled sailplane. The cover picture was taken at one such session. The fellow holding the control stick (the one that looks like a movie actor) is Arthur L. Lawrence, Secretary of the Soaring Society of America—and chief instructor to the Hartford group. Adjusting the gadgets inside the plane is C. C. Rodimon, W1SZ, while Byron Goodman, W1JPE, does a strenuous bit of observing.

## Massachusetts State Convention

(New England Division)

Boston, Mass. October 2nd.

THE Eastern Massachusetts Amateur Radio Association and the South Shore Radio Club are the sponsors for this year's Mass. State Convention and Boston Hamfest to be held at the Hotel Bradford, Boston, Mass., October 2nd.

As usual a program worthy of the efforts of the committee has been prepared and everyone who attends will be fully repaid in enjoyment.

If further information is desired drop a line to Don Meserve, 140 Forest Ave., Hudson, Mass.

## Midwest Division Convention

Kansas City, October 9th and 10th

Get all set for an unusually good convention of the Midwest in Kansas City's new municipal auditorium the second week-end in October. Sponsored by the Heart of America Radio Club and the O.B.P., an unusually interesting and full program has been arranged.

Getting acquainted starts Saturday morning at the auditorium, during which session there are also Class A and B exams by the local inspector and a code speed contest under the direction of Tex McElroy. In the afternoon the Mayor welcomes the gang and meetings start. Speakers include George Bailey, Vice-President of the League; Floyd Norwine, Director of the Midwest; and by Goodman from Headquarters. Round tables for A.A.R.S. and N.C.R., for phone and C.W. gangs each under competent leadership. Technical speakers include representatives from R.C.A., Jefferson, Raytheon, G.E., T.W.A., and Bell-Labs. A television demonstration, a 5-meter contest, and a Wouff Hong initiation Saturday midnight. Some inspection trips. Herb Hollister presides over the banquet Sunday afternoon. Yep, prizes—lots.

Pretty good, wot? Swell time assured.

# HINTS and KINKS for the Experimenter



## Power Supply for Battery or A. C. Use

FROM time to time various experimenters have suggested the use of a b.c. type transformer in conjunction with Ford coils to secure 350 volts or

practical one now comes from James McBride, W4BAF, whose supply can be used either on 6 volts d.c. or 110 volts a.c., whichever may be available. In the interests of reliability, W4BAF's rig uses a standard vibrator of the type universally incorporated in auto radios.

The circuit diagram of the power supply is given in Fig. 1. The transformer is a standard b.c. job with a 6.3-volt winding, this winding being used as the primary with 6-volt battery supply. This winding should have fairly heavy current-carrying capacity, since the battery current runs as high as 12 amperes under load. The vibrator used by W4BAF is of the synchronous type with the contacts strapped together to use it non-synchronous. The rectifier is an OZ4, a gas tube without a hot cathode. A conventional filter is used.

The diagram shows the various switches necessary to change from battery to a.c. supply. All switches are shown in the battery-supply position. When operating on a.c. the vibrator is cut out of the circuit and the 6.3-volt winding resumes its normal function of furnishing filament power for the tubes.

The coils  $L_2$  and  $L_3$  are part of a filter intended to cut out "hash" from the vibrator. They are probably subject to some experimenting to obtain best suppression of noise, but coils consisting of 20 or so turns of No. 12 wire, wound to 1-inch diameter, are suggested.

W4BAF's power supply delivers 90 milliamperes at 350 volts with either a.c. or battery supply. It has proved to be highly effective in operating a 6C6-41 receiver and 6L6 transmitter both portable and at home.

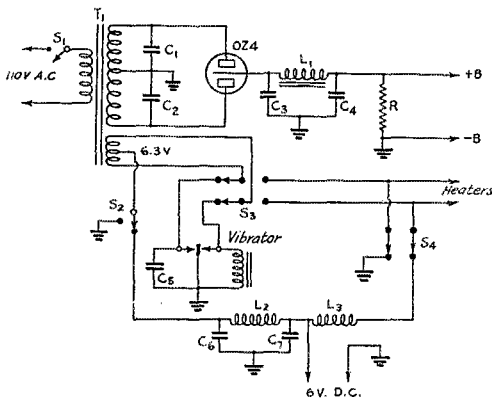

FIG. 1—POWER SUPPLY FOR RECEIVER OR LOW-POWER TRANSMITTER WHICH WILL OPERATE EITHER FROM THE A.C. LINE OR A 6-VOLT STORAGE BATTERY

- T—B.c. type power transformer with 6.3-volt winding.
- $C_1, C_2$ —0.002- $\mu$ f.d., 1000-volt.
- $C_3, C_4$ —8- $\mu$ f.d. electrolytics, 450-volt.
- $C_5, C_7$ —0.002- $\mu$ f.d., 1000-volt.
- $C_6, C_7$ —0.5- $\mu$ f.d. paper.
- $L_1$ —30-henry filter choke.
- $L_2, L_3$ —Hash-filter chokes (see text).
- $S_1$ —S.p.s.t. switch.
- $S_2$ —S.p.d.t. switch.
- $S_3$ —D.p.d.t. switch.
- $S_4$ —D.p.s.t. switch.
- R—Bleeder resistor, 25,000–50,000 ohms.

so for the operation of a receiver or portable transmitter from a 6-volt storage battery. An arrangement which strikes us as being a highly

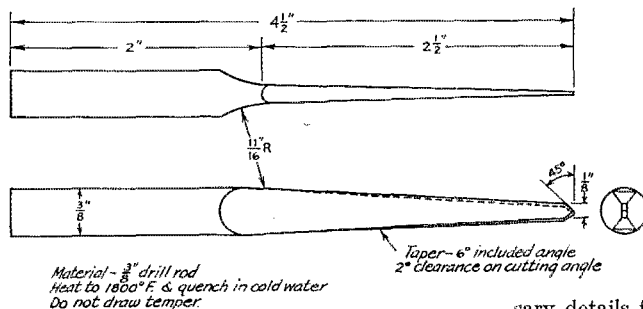

FIG. 2—DRILL FOR CUTTING GLASS

## Drilling Glass, Porcelain and Pyrex

THE perennial problem of drilling holes in glass has had many solutions; we present here another, successfully used by H. W. Loney, ex-9DHO, and J. P. Gilliam, W9SVH. The special tool depicted in Fig. 2 is an important part of the process.

The drawing gives all the necessary details for its construction. For the actual drilling, the authors write:

"Place the drill as shown on the attached blueprint in a hand brace, engine lathe or slow speed drill press. If the material to be drilled is flat, such as plate glass, make sure that the supporting

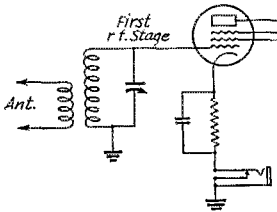

FIG. 3—FIRST R.F. TUBE IN RECEIVER AS A 'PHONE MONITOR

surface is flat. Apply turpentine to the point of the drill and press firmly against the work in the desired location. Then turn the drill slowly and apply sufficient turpentine to keep the drill wet at all times. Use care when breaking the point through the work so as to avoid chipping. After the point has broken through, turn the work over and drill from the opposite side, repeating this operation as often as is necessary to keep the edges of the hole nearly parallel.

"This has been the most successful method of drilling these materials that we have been able to find. We find it quite possible and practical to drill narrow strips of glass where the holes are close to the edge. Repeated tests have proved that when using a hand brace it is possible to drill 1/4-inch diameter holes through 7/32-inch plate glass in 35 seconds.

"Pyrex is somewhat tougher than ordinary glass and will cut considerably slower. Four Pyrex custard cups were drilled in approximately four minutes. Ordinary porcelain such as is used for antenna insulators may be drilled with the same speed as plate glass."

— . . . —

### 'Phone Monitoring Kink

FROM Caldwell Smith, W5FKW, comes a suggestion for making use of the grid current that usually flows in the first r.f. stage of a receiver during transmitting periods, even though the "B" supply is switched off. W5FKW simply inserts a headset in series with the grid return so that the quality of 'phone transmissions can be checked. One method of doing it is shown in Fig. 3. The 'phones should be removed from the jack or short-circuited during reception.

This arrangement is nothing more than the familiar diode detector, the grid of the first r.f. tube acting as the diode plate. Makes a good 'phone monitor, and requires nothing more than a jack.

### Yet Another Use for the Magic Eye

THE resistance-coupled push-pull and phase-inverting types of audio amplifier are essentially made up of the same parts and are open to the same troublesome objection: There is in the absence of frequent testing no assurance that good symmetry exists, and without it maximum power and minimum distortion cannot be realized. The 6E5 electron-ray indicator provides an inexpensive and convenient means of assuring that both power tubes receive the same signal in such an amplifier.

In Fig. 4,  $R_1$  and  $R_2$  are identical input volume controls, of resistance depending on the service;  $R_3$  and  $R_4$  are determined by the tubes used.  $R_5$ , depending on the service, is high enough so that in phase-inverter connection the setting of  $R_2$  will not be too critical.  $R_6$  is 1 megohm,  $R_7$  a 1-megohm volume control,  $R_8$  0.1 to 1/4 megohm,  $C_1$  is 0.01  $\mu$ fd. The 6E5 functions as a grid de-

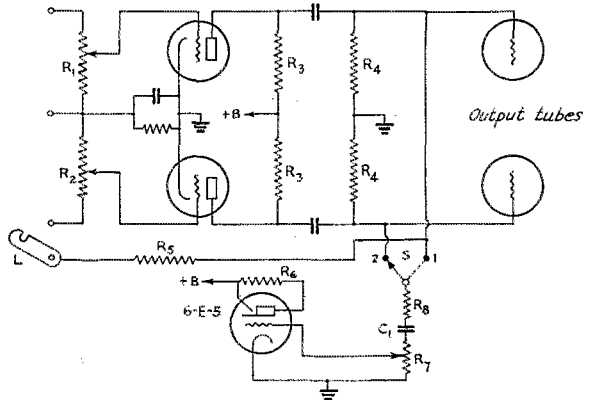

FIG. 4—USING A 6E5 AS A BALANCE INDICATOR IN RESISTANCE-COUPLED PUSH-PULL OR PHASE-INVERTING AMPLIFIERS

See text for constants.

tector and its pattern closes at some certain signal, determined by the setting of  $R_7$ .

Push-pull operation: Apply signal across  $R_1$  plus  $R_2$ , leaving link  $L$  open. Give (for example)  $R_1$  an arbitrary scale. Then for each setting of  $R_1$ , with the s.p.d.t. switch  $S$  in Position 1, set  $R_7$  for exact closing of the pattern, and without changing setting of  $R_7$  flip  $S$  to Position 2 and mark the setting of  $R_2$  which gives exact closing. Repeat at various levels. This method gives balance independent of the whims of irregular carbon volume controls: once calibrated, these are set to like readings; the calibration is checked as often as necessary.

Phase inverter operation: Apply signal across  $R_1$ . Close link  $L$ . At any convenient level, set  $R_7$  for exact closing and adjust  $R_2$  so that  $S$  may be flipped back and forth without change in

(Continued on page 116)

# • I. A. R. U. NEWS •

Devoted to the interests and activities of the

## INTERNATIONAL AMATEUR RADIO UNION

Headquarters Society: THE AMERICAN RADIO RELAY LEAGUE, West Hartford, Conn.

### MEMBER SOCIETIES

American Radio Relay League  
 Associazione Radiotecnica Italiana  
 Canadian Section A.R.R.L.  
 Ceskoslovenski Amatérí Vysílací  
 Deutscher Amateur Sende-und-Empfangs  
 Dienst  
 Experimenterende Danske Radioamatører  
 Irish Radio Transmitters Society  
 日本アマチュア無線聯盟 Japan  
 Liga Colombiana de Radio Aficionados  
 Liga Mexicana de Radio Experimentadores

Magyar Rövidhullámú Amatőrök Országos  
 Egyesülete  
 Nederlandsche Vereeniging voor Internationaal Radioamateurisme  
 Nederlandsch-Indische Vereeniging voor Internationaal Radioamateurisme  
 Newfoundland Amateur Radio Association  
 New Zealand Association of Radio Transmitters  
 Norsk Radio Relæ Liga  
 Oesterreichischer Versuchssenderverband  
 Polski Związek Krotkofalowcow

Radio Club Venezolano  
 Radio Society of Great Britain  
 Rede dos Emissores Portugueses  
 Réseau Belge  
 Réseau des Emetteurs Français  
 South African Radio Relay League  
 Suomen Radioamatöörlitto r.y.  
 Sveriges Sandareamatörer  
 Unión de Radioemisoros Españoles  
 Union-Schweiz Kurzwellen Amateur  
 Wireless Institute of Australia

## Conducted by Byron Goodman

### Denmark:

On August 15, 1937, the *Experimenterende Danske Radioamatører* celebrated its tenth anniversary as the Danish National Amateur Society. During its ten years the E.D.R. has grown, under the capable management of its officers, from a small body of 70 members to one of over 550, with 29 licensed amateurs in 1927 and 306 in 1937. Throughout this time their patron and *protektor* has been famous Professor P. O. Pedersen, Director of the Royal Technical College of Copenhagen. The E.D.R. has been a member-society of the Union for eight years.

During the past three years the growth of the society has been quite rapid, under the leadership of presidents Paul Heinemann, OZ4H; James Steffensen, OZ2Q; and Ahrent Flensburg, OZ1D, who also served as secretary from 1932 until his election to the presidency in 1936. Much credit is also due Helmer Fogedgaard, OZ7F, editor of "OZ," the society's official monthly publication, for his work in building up the periodical to the point where it is now one of the finest European amateur magazines. Their anniversary issue of 64 pages is a splendid tribute to the society and the men responsible for its success.

Although the E.D.R. has not sponsored any world-wide contests, they have conducted, in conjunction with the other Scandinavian countries, several small contests. One of the big events of the year, somewhat in the nature of a convention, is their summer-camp activity, when OZ7EDR is set up as a portable in some suitable spot and everyone takes a turn at operating, with plenty of swimming and that good Danish cooking for those not operating the rigs. This year the camp was located at Genner, was visited by D's and LA's.

The headquarters society joins with the other member-societies in offering hearty congratulations and best wishes to the E.D.R. on their tenth anniversary.

### WAC:

The past few years have seen a tremendous growth in the number of WAC certificates issued, due presumably to better conditions and greater DX activity. It is interesting to see just how many certificates have been issued to the various districts and countries, and we therefore list below the number of WAC certificates issued up to July, 1937:

W1	135 c.w.,	6 'phone	EA	44 c.w.,	1 'phone
W2	124 c.w.,	4 'phone	EI	4 c.w.	
W3	107 c.w.,	6 'phone	ES	3 c.w.	
W4	68 c.w.,	4 'phone	F	59 c.w.,	5 'phone
W5	102 c.w.,	2 'phone	FBS	2 c.w.,	1 'phone
W6	253 c.w.,	10 'phone	G	252 c.w.,	11 'phone
W7	59 c.w.,	3 'phone	GI	7 c.w.,	1 'phone
W8	166 c.w.,	4 'phone	HA	16 c.w.	
W9	226 c.w.,	5 'phone	HB	22 c.w.,	2 'phone
K4	6 c.w.		HC	1 c.w.	
K5	5 c.w.		HI		1 'phone
K6	20 c.w.,	1 'phone	HK	1 c.w.,	1 'phone
K6 (Guam)	3 c.w.		I	10 c.w.,	2 'phone
KA	13 c.w.,	1 'phone	J	57 c.w.,	1 'phone
VE1	10 c.w.,	1 'phone	J8	2 c.w.	
VE2	10 c.w.,	1 'phone	LA	23 c.w.,	1 'phone
VE3	13 c.w.		LU	8 c.w.,	1 'phone
VE4	13 c.w.		LY	3 c.w.,	1 'phone
VE5	10 c.w.,	1 'phone	MX	1 c.w.	
CE	9 c.w.		OA		1 'phone
CM	3 c.w.,	1 'phone	OE	19 c.w.	
CN8	1 c.w.		OH	1 c.w.	
CR7	2 c.w.		OK	51 c.w.,	1 'phone
CR9	1 c.w.		ON	77 c.w.,	11 'phone
CT	22 c.w.		OQ	1 c.w.	
CT2	2 c.w.		OZ	23 c.w.	
CT3	1 c.w.		PA	67 c.w.,	1 'phone
CX	14 c.w.		PK	12 c.w.,	3 'phone
D	127 c.w.		PY	19 c.w.	

SM	29 c.w.	VS5	1 c.w.
SP	28 c.w.	VS6	4 c.w.
ST	1 c.w.	VS7	5 c.w., 1 'phone
SU	1 c.w., 2 'phone	VU	11 c.w., 1 'phone
TI	1 'phone	XE	11 c.w., 2 'phone
VK	148 c.w., 5 'phone	XU	19 c.w.
VK7	3 c.w.	YI	2 c.w.
VO	1 c.w.	YL	2 c.w.
VP2	2 c.w.	YM	1 c.w.
VP5	2 c.w.	YR	2 c.w.
VP6	1 'phone	YT	5 c.w.
VP9	1 c.w.	ZB1	1 c.w.
VQ2	2 c.w.	ZC6	1 c.w.
VQ3	1 c.w.	ZD2	1 c.w.
VQ4	5 c.w.	ZEI	9 c.w., 2 'phone
VQ8	3 c.w.	ZL	71 c.w.
VS1	1 c.w.	ZP	1 c.w.
VS2	2 c.w.	ZS	92 c.w., 8 'phone

The California kilowatts seem to speak for themselves, except that the G's have them topped.

To get an idea of the number of certificates issued during the past 18 months, compare the above figures with those given in the July and November, 1936, issues of QST.

#### QSL Bureaus:

Following is a list of the foreign QSL Bureaus to which QSL cards may be sent for distribution. Remember that many of these bureaus now refuse to handle SWL cards and reports, and therefore listener reports should be sent directly to the station heard.

Alaska: Leo E. Osterman, Customhouse, Wrangell.  
 Antigua: R. V. Tibbits, High Street, St. Johns, Antigua, B. W. I.  
 Argentine: Radio Club del Argentina, Rividavia 2170, Buenos Aires.  
 Australia: Willy Blaschek, O.V.S.V., Bahngasse 29, Klosterneuberg.  
 Barbados: see Antigua.  
 Belgium: Baron Bonaert de la Roche, ON4HM, Chateau de Marchiennes, Harverngt nr. Mons.  
 Bermuda: Alfred E. Redman, "Elsing," Middle Road, Devonshire.  
 Bolivia: Henry E. J. Smith, c/o Standard Oil Co. of Bolivia, La Paz.  
 Borneo: see Malaya.  
 Brazil: L.A.B.R.E.L., Caixa Postal 26, São Paulo.  
 British Guiana: see Antigua.  
 British Honduras: D. Hunter, Box 178, Belize.  
 Canal Zone: John J. Carr, 78th Pursuit Squadron, Albrook Field.  
 Ceylon: Radio Club of Ceylon and South India, P. O. Box 232, Colombo.  
 Chile: Luis M. Desmaris, Casilla 761, Santiago.  
 China: I.A.R.A.C., Box 685, Shanghai.  
 Colombia: L.C.R.A., Apartado 330, Bogota.

Costa Rica: Federico Gonzales, Box 384, San José.  
 Cuba: Adolfo Dominguez, Milagros 37, Vibora, Habana.  
 Czechoslovakia: C.A.V., Post Box 69, Praha 1.  
 Denmark: E.D.R., Postbox 79, Copenhagen K.  
 Dominican Republic: H. H. Gosling, Calle Cesar Nicolas Penson, Ciudad, Trujillo.  
 Ecuador: Carlos Cordover, Box 30, Rio Bamba.  
 Egypt: F. H. Pettitt, Catholic Club, Mustapha Barracks, Alexandria.  
 England: R.S.G.B., 53 Victoria St., London, S. W. 1.  
 Estonia: E.R.A.U., Box 220, Tallin.  
 Federated Malay States: Reginald J. Bee, Malayan Public Works Service, Kuala Kangsar, Perak.  
 Finland: S.R.A.L., Pohjola, Box 42, Helsinki.  
 France (and any country with prefix beginning with "F"): Reseau des Emetteurs Français, 6 Square de la Dordogne, Paris, 17.  
 Germany: D.A.S.D., Schweinfurthstr. 78, Berlin-Dahlem.  
 Greece: C. Tavaniotis, 17-a Bucharest St., Athens.  
 Guam: C. R. Spicer, Naval Communication Office, Agana.  
 Haiti: Via A.R.R.L.  
 Hawaii: James F. Pa, K6LBH, 1416D Lunalilo St., Honolulu.  
 Hong Kong: H.A.R.T.S., Box 651.

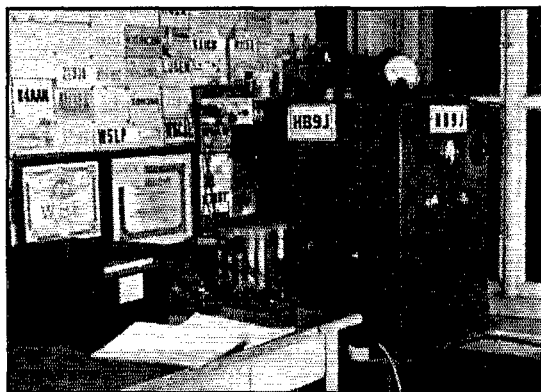

#### THE WELL-KNOWN SWISS STATION HB9J

Jean Lips has built up an enviable record as an operator through his splendid work in many international contests. The rig is 59-RK23-RK20 running at 50 watts input, and the antenna is a full-wave end-fed on 7 Mc. All bands from 160 to 5 meters are used. HB9J is WAC and WBE, 'phone and c.w., on two bands, and has worked 108 countries.

Hungary: National Union of Hungarian Short Wave Amateurs, VIII, Maytaster 6, Budapest.  
 India: B. M. Tanna, Satya Sadan, Santa Cruz.  
 Irish Free State: I.R.T.S. 23, Sth. William St., Dublin.  
 Italy: Dr. Ing. Robeter Ognibene, via S. Nicolao N. 1, Milan.  
 Jamaica: Cyril M. Lyons, 2-B North St., Kingston.  
 Japan: J.A.R.L., P. O. Box 377, Tokyo.  
 Java: see Netherland East Indies.  
 Jugoslavia: Stephen Liebermann, Meduluceva 9, Zagreb.  
 Kenya: R.S.E.A., Box 570, Nairobi.  
 Latvia: L.R.B., Post Box 201, Riga.  
 Lithuania: L.R.M., Post Box 100, Kaunas.  
 Luxembourg: J. Wolff, Rue Pierre D'Aspelt 8, Luxembourg.  
 Madeira: see Portugal.  
 Malaya (and Borneo): J. MacIntosh, c/o Posts & Telegraphs Dept., Penang, Straits Settlements.  
 Mexico: L.M.R.E., Sinaloa 33, Mexico City.  
 Morocco: A.A.E.M., BP 50, Casablanca.  
 Netherlands: N.V.I.R., Post Box 400, Rotterdam.  
 Netherlands East Indies: Ir. J. M. van Heusden, N.I.V.I.R.A., Palmenlaan 1, Bandoeng.  
 Newfoundland: Newfoundland Amateur Radio Assn., c/o E. S. Holden, P. O. Box 650, St. John's.  
 New Zealand: N.Z.A.R.T., P. O. Box 374, Dunedin.  
 Nicaragua: Ernest Andreas, YN1OP, Estacion Radio-difusora Bayer YNOP, Managua.  
 Norway: N.R.R.L., P. O. Box 2253, Oslo.  
 Republic of Panama: R. D. Prescott, Box 32, Panama.  
 Palestine: Frank H. Pettitt, Catholic Club, Mustapha Barracks, Alexandria, Egypt.  
 Peru: Radio Club of Peruano, Apartado 538, Lima.  
 Philippine Islands: George L. Rickard, P. O. 849, Manila.  
 Poland: P.Z.K., Bielowskiego 6, Lwow.  
 Puerto Rico: Francis M. McCown, Family Court No. 7, Santurce.  
 Portugal: R.E.P., Rua Dos Sabarteiros 159-3, Lisbon.  
 (Continued on page 118)



# OPERATING NEWS



Conducted by the Communications Department

F. E. Handy, Communications Manager

E. L. Battey, Asst. Communications Manager

A NEW SEASON of amateur radio operating is with us, a fresh page on which to record our ability to communicate. There will be all the usual A.R.R.L. activities, and we are studying the possibilities of a Red Cross Relay, and a special QSO Party for "all A.R.R.L. members" as 1938 additions to the usual program. Besides bigger and better operating fun, the new year in amateur radio will provide fresh opportunity for each of us to study technique and prepare ourselves in operating and organization methods that will add to our public service record, so long outstanding in emergencies. To have equipment is one thing; to be able to use it well with organized skill and effectiveness is another. The tried and tested way to operating progress and individual progress as well is to get lined up with S.C.M.'s for appointments along the lines of natural interest and qualification. Along with fun for those amateurs in special organization posts there will be serious study given our emergency service with local tests to further coordination, effect contacts with agencies to be served, and to make possible the registration of all amateurs at local centers so that the actual facilities will be known and frequency-band organizations in each amateur group can be worked out. Come flood, hurricane or earthquake, each amateur should have planned emergency power facilities, and be able to render good account of himself. As the Field Day and Low Power Contest have suggested, "organization preparedness" is our aim. We suggest "individual preparedness" as your responsibility.

Of course you want to get in on all activities. If your station is not at present active in the League's field organization drop a postal to your SCM (address page 5), give him the lineup of your equipment, and tell him your main operating frequency and special interest. Ask about appointments and he will send information or have us send it to you. League Trunk Lines, O.R.S. and O.P.S. nets will be made up of the best qualified member-operators expressing interest.

We want every active operator to be part of the League's field organization—to register his facilities as part of A.R.R.L.'s Emergency Corps so he can receive the special plans and information on QRR work.

A new A.R.R.L. appointment, that of A.R.R.L. Emergency Coördinator, will be added to the list of organization posts this year. One will be appointed after a thorough survey of the field with recommendations of prominent amateurs and clubs, in each large community (over 25,000 citizens or over 20 active amateurs) as soon as Section Communications Managers have completed their studies. More information on the responsibilities and functioning of an A.R.R.L. Coördinator, and how each of us individual amateurs should cooperate with him in local-community planning, and registering of facilities, in next QST.

"Shack walls." We recently received a letter containing informal expression of what many an amateur has sought to put in words concerning the fraternalism and constructive values in our ham work. It speaks for itself, so without further explanation we quote: "My shack is plastered with all the cards the walls can hold. I like to spot W5CEZ's card on the wall. This expression is not for vanity's sake, for I have few ham visitors. It's done for the comradeship these cards give—they each represent a QSO; maybe a short, snappy contest QSO or maybe a nice ragchew but one way or the other they are a memory—of a QSO. By the same token I have tacked up on the wall all my certificates, my ORS appointment, my AARS certification, my OBS appointment, my TL appointments, an award from an A.R.R.L. 'SS' Contest, and of course my League membership certificate and licenses. These certificates, along with my QSL cards, represent a great piece of my amateur radio experience. I treasure them all. Happy experiences are really two-fold in their joys for, in addition to the actual experiences, we have the pleasure of the memories they bestow upon us. That's what the walls of my shack mean to me."

—W9IYA.

The A.R.R.L. Sweepstakes dates? November 13th-14th, November 20th-21st. Full details of this time honored activity next month. Polish up the stations for new QSO-opportunity. All set for the "SS"!

—F.E.H.

## Cincinnati Get-Together

Amateurs of Southern Ohio and Northern Kentucky gathered on Sunday, August 15th, to enjoy the annual picnic and get-together held under the joint auspices of the Greater Cincinnati Amateur Radio Assn. and the N.C.R. Units of that Section; 169 attended the all-day affair in the fair grounds outside of Florence, Ky., a few miles south of Cincinnati. The program, which was entirely informal, consisted of a lot of very enthusiastic picnic activities, such as a tug-o'-war with prizes of lollipops to the winners and consolation prizes, also lollipops, to the losers and an egg-throwing contest. Both lunch and dinner were served. A.R.R.L. Director Mathews, W9ZN, organized a baseball team consisting of old-timers of the Spark days, and another team composed of both c.w. and 'phone operators. The two teams, with substitutes, included: Sparks—W8DWS W8AMT K6BAZ W8NK W9ZN W8BFB W8DQC W8QAA W9FS W8FN W8BAE W8BOS W8BTI W8DSW. C.W. & 'Phone—W8LW W9WLX W9VVR W8EFS W8PPK W9LXB W8WLK W8QAD W8NMS W8PNW W8EDX W9RBQ and three S.W.L.'s, J. Rieg, Bukle, Vic Adam. The Sparks won by a score of 19 to 6 and the old cheer "Spark forever" rang out anew.

-----  
**73 and 88!**

W9PTU finds in the book "Mathematics for the Million" by L. Hogben, in the chapter on the beginnings of arithmetic, "The idealistic teaching which brought large audiences to hear Pythagoras (582-507 B.C.) is illustrated by the way he invested numbers and figures with moral qualities." The author then lists some of the qualities given to figures. Those in question: "3—potency, 7—health, 8—love." From this 73 can be interpreted "strength and health" and 88 as "love," or as they are given in the list of abbreviations! See April 1934 QST (page 45) and April 1935 QST (page 60) for two interesting items on the "origin of 73."

## Los Angeles Radio Program

The program under the auspices of Los Angeles Section amateurs over broadcast station KMTR has been resumed. The period 12:00 midnight to 12:30 A.M. PST each Saturday night (Sunday morning) is set aside for these broadcasts. The program is informal and suggestions are requested. Clubs are invited to put on skits and to provide talent for the broadcasts. Contributions of talent and suggestions may be made through Jimmy Guest, W6HCN, operator at KMTR, or to Don Draper, W6GXM, S.O.M. for the L.A. Section. KMTR operates on 570 kc. with 1000 watts of power; reports on reception and quality of program are always appreciated.

On July 21 W6CDA handled a nice bit of QRR traffic for the U.S.S. *Mallard* in the Caribbean Sea. The ship's transmitter was out of order and NY2AC used portable to contact the sub-base at Coco Solo via W6CDA-NPG.

W7FIB, Cheyenne, Wyo., called CQ on the evening of August 14th and was answered by W4DRK, Alachua, Fla., with a message for Aubrey Fincher, an Alachua boy who had been in the Memorial Hospital in Cheyenne for two weeks. W7FIB delivered the message personally August 15th and received a reply that he relayed to W4DRK on schedule the following morning. Just three hours after W7FIB left the hospital, Aubrey died. The message was his last and it, with details about his death, was relayed to his folks in Alachua. Another ham service, deeply appreciated.

W8JVN, Cleveland, Ohio, has been active in organizing a Portable Amateurs Club in that city. The idea back of the organization is that all members have portable equipment available at all times for possible emergencies. The group operates on 'phone on the 1.75 and 56-Mc. bands. The P.A.C. has done some good work assisting various game and fish conservation clubs.

Coincidence: GI6TK QSO'd W7EUY, Everett, Wash.: his next QSO was with W1FID, Everett, Mass.

## New Guinea Expedition

The American Museum of Natural History Expedition's advance party to New Guinea left October 5th, and another ship of the same type will follow in January. The scientists expect to be there for a full year from January 1st. The Museum plans are made in cooperation with Mr. Richard Archibald, research backer. Personnel includes three scientists, two radio men, a pilot and a flight engineer—some of the same men recently busied in searching for the Soviet fliers. Of greatest interest to U. S. amateurs will be the fact that the radio men are both amateurs—Harold Ramm of W2FEF, and Raymond Booth, W3—, who will man the base and advance stations, respectively.

Contact from the base (Hollandria) will be maintained on frequencies assigned by the Dutch government in the next few weeks. There will be ample radio equipment for all needs. A 500-watt transmitter, crystal 837, RK46 doublet and 805s output (mod. 805s) will be the base station; 26 amateur band crystals are being taken along. Tests with W10XRA have been completed on regular aircraft frequencies, 500 kc., 3105, 6210 and 12,420 kcs. 'Phone will be used as much as possible with shift to c.w. as necessary to get through tropical QRN and interference. After flying the plane down the Pacific, radio will also be used for contact with advance parties and when flying in food to be dropped to those parties. Two HRO receivers will be used, two portable transmitters also, and the planes will be equipped with direction finder and additional 26-watt portables using 837's. The large ship transmitter is a 100-watt job (210-865-RK46s) and receivers are Bendix made.

W2FEF promises more radio news from the expedition from time to time. New Guinea is near Java and while there will be but a modest traffic load for the U. S. A. amateur contacts for the expedition personnel from this country will be valued.

Do you report your activities to the Section Communications Manager for your Section each month on the 16th? He would welcome a word from you regarding your doings. See page 5, this issue QST, for his address.

It won't be so hard for the YL's to drag the lads to the movies, if the producers continue to include the ham touch noted by W7EPC in a recent cartoon entitled "Porky's Train." In this comic a train dispatcher transmitted the following in about 500 cycle i.e.w.: "QST QSL Leon Schlesinger to Hollywood for picture of Porky." It was sent at about 15 w.p.m.

## VE2KI

A Science Service release dated August 10th tells of Pere Arthème Dutilly, Canadian scientist-priest, who is exploring the Arctic on a one-man botanical expedition. In his tiny boat, built in Holland, Pere Dutilly expected to pass the coast of Labrador about July 20th and be near Chidley on August 1st. Between that date and August 15th he expected to enter the Straits leading to Hudson's Bay and arrive at Churchill on August 15th. His itinerary takes him northward to Cape Eskimo, Chesterfield Inlet, Baker Lake, Southampton, Repulse Bay and Igloolik. He will return to Quebec about October 1st.

Pere Dutilly has radio gear aboard, operating in the 14- and 28-Mc. amateur bands under the call VE2KI (his own call). Transmissions are scheduled on 14 Mc. Saturdays at 2:30 P.M. EST and Sundays at 2:00 and 3:00 P.M. On 28 Mc. look for him Sundays at 9:00 A.M. EST. Broadcasts are also made under the call CYNT on 23, 36, 87.72, and 160 meters.

W2KAK reports taking much traffic for New York from VE2KI/VE5KI on the Arctic ice breaker *St. Therese*. Please report contacts VE2KI/5KI to A.R.R.L.

Beginners in Cleveland, Ohio, note: The Delta Y Radio Club, located at the West Side Y.M.C.A. on Franklin Blvd., has regular beginners' classes in radio every Monday and Friday from 7:30 to 10:00 P.M. There is no charge of any sort. W8LWZ, W8QLB, W8LBJ and W8MWS, club members, are willing to instruct anyone who wishes to get a license.



## PRIZES FOR BEST ARTICLES

The article by Mr. Eric Ledín, W6MUF wins the C.D. article contest prize this month. Each month we print the most interesting and valuable article received marked "for the C.D. contest." Contributions may be on any phase of amateur operating or communication activity (DX, 'phone, traffic, rag-chewing, clubs, fraternalism, etc.) which adds constructively to amateur organization work. Prize winners may select a 1937 bound *Handbook*, QST Binder and League Emblem, six logs, eight pads radiogram blanks, DX Map and three pads, or any other combination of A.R.R.L. supplies of equivalent value. Try your luck. Send your contribution to-day!

## Club QSO's By Eric Ledín, W6MUF\*

A HAM club, no matter how embryonic, has more potentialities for real QSO's than a KW. on 14 Mc., or any other band when that band is hot. Why it should be more difficult to start a chat with the stranger sitting next to you than to raise him on the air for an hour of rag-chewing is one for Ripley.

One other tell-tale Zepp feeder shares the blame in our town for everything from power leaks to noisy tubes. It is natural that there should be a well-worn path between our shacks. When the new super bowed out in favor of a battered Model A, plans were speedily made to join the county ham club holding forth once a month in a neighboring town.

Neither of us had ever attended a formal club meeting, and our anticipations were high as we went dutch on three gallons of gas. We were anxious to meet that snappy 7-Mc. op. who always snared the ones we called, with only 40 watts to his 6L6. We were looking for the chap with a ¼ KW. on 56 Mc. The call of that beautiful 'phone was as familiar to us as a name, but whether he was tall, short, or forty, — that was something else.

We pictured a cosy hall with everyone chatting comfortably and hashing things over in a new way. The same old things we had spent hours gassing over together but with new slants. Perhaps a new side-kick for that fishing trip, or perhaps I could swap that standby receiver for a Transceiver. Probably visit some stations after the meeting. Maybe there would be some one with an XYL so the girls could get together while we tinkered.

The meeting was scheduled for 8 o'clock, but until 8:45 no one made a move for the door of the club house. We stood with frozen grins, lighting one fag after another, and trying to edge up in turn to each of the five groups loitering apart from each other. Once we were looked over casually by a late arrival but clearing my throat was a signal for him to fade.

The meeting was finally under way and, in justice to all, they may have been handicapped by the fact that it was a business meeting. The chairman furnished plenty of comic relief by his unique talent at slaughtering parliamentary law but, aside from that, an hour passed in tedious haggling with the ultimate accomplishment of a general re-election. Before the final ballot a delegate had been sent to order hamburgers in advance, and the meeting was dismissed. The original groups dashed out together for the restaurant, and our lights pointed homeward without having met a single ham. Our chat was no longer of radio, but of personalities.

Since this disappointing experience we have sought other clubs. Our disillusionment is not complete. We have found many excellent features here and there which convince us that by an intelligent program, an ideal amateur club can be evolved.

Perhaps the fault was greatly ours at that first meeting. Deliberately breaking into one of these cliques and demanding attention through the sheer desire for it may have

\*244 Excelsior Lane, Sausalito, Calif.

turned the trick; however, in our attitude we were representative, I am sure, of all strangers among strange groups and the advantage is completely with the old timers.

The necessity of new blood and the acquisition of every new ham in the neighborhood is, I am certain, obvious to every officer of such organizations. Sending an announcement, however, is not enough. A little genuine "glad-handing" and a little more attention towards the actual mechanics of the meetings will go a long way.

One club immediately made the rounds of all those present, calling on each one to rise and give his name and call letters, if any. Being visitors, we were accorded a "hand" which at once made us feel at home. This club, incidentally, raised funds entirely by raffling a few prizes at each meeting, and I saw no one hesitate at buying cheap chances on good tubes, a call book, or a condenser.

Another simple stunt, never failing to offer entertainment when the speaker fails to show up, is that of drawing call letters from a hat, the goats being required in order, to speak 10 minutes on subjects similarly drawn. Offhand we can remember two speeches which were highly amusing. "Why I stick to my present antenna" was drawn by a chap who was in the throes of wrestling with an obstinate new rhombic, and "The best DX I have ever worked" was drawn by a painfully honest and embarrassed ham who somehow hadn't been able to get out of the district.

We are forming a small radio club, but we intend that it shall be a replica of our first mental picture that night we set out in the now deceased flivver. By attending the limited number of clubs within range we have gleaned much and discarded more. One simple idea may save the evening, but a dozen would save the club.

## Briefs

Word just received from S.C.M. Treadaway, W5DKR, is that Louisiana hams will have their get-together meeting Oct. 23d-24th instead of Oct. 30th-31st.

The Royal City Amateur Radio Association would like to get in touch with all Canadian radio clubs. Every club in the Dominion is asked to write to the secretary giving address so that R.C.A.R.A. may communicate with you. Address F. B. Hughes, 221 Eleventh Street, New Westminster, British Columbia.

## Three Days at the Races

The 1937 World's Championship Mothboat Races were held at Atlantic City, N. J., August 12th-14th-15th. Owing to the peculiar dog-leg course followed by the contestants it was impossible for the boats to be seen constantly from the docks. Because of this and satisfactory activity along the same lines in the 1936 Regatta, W3DOD and W4BRB were asked to report the races via 56-Mc. 'phone. With the aid of the local Coast Guard this was accomplished.

W3DOD/3 was installed in the elevated judges' stand. 110 juice was available at this point as well as the mike leading to the P.A. system in the clubhouse of the Evening Star Yacht Club, sponsors of the affair. W4BRB/3, using a transceiver, was located in the bow of a Coast Guard surfboat which followed the contestants around the course. On the long runs between each buoy the surfboat ran abreast of the leaders, allowing a close description back to the judges' stand, from where it was fed into the P.A. system.

In one of the YL races, one of the gals capsized her boat. This was seen from the judges' stand, from where the C.G. boat was directed to the rescue! All in all we had a lot of fun. We have been invited to return in 1938, and the local club is making plans to equip several launches with the necessary gear to cover the entire course with two-way radiophone. As W3DOD said, "It was all very nautical but nice!"

—W4BRB

At 10:23 P.M. MST on August 24th, W7CPY signed with K6NZQ on 14-Mc. 'phone, having taken a message for K6LKN. At 10:31 P.M. he raised K6NTV, in the same city as K6LKN, gave him the message and it was immediately phoned to K6LKN. Total elapsed time—less than 15 minutes!

# How's DX?

## How:

Although 14- and 28-Mc. DX is probably going to be great stuff this winter season, we would like to see some of the gang get up on 7 Mc. for a sort of a revival. The band isn't used an awful lot for DX except on the west coast where the old reliables still hold down their trans-Pacific traffic schedules. It's true, of course, that many Europeans have become discouraged from using it simply because of the splashy European 7-Mc. 'phones that take up so much of the band, but some determined effort might bring things around to a happier condition.

On the other hand, we stand prepared to promote a gigantic campaign to raise a large sum of money to buy the band and give it back to the DX gang. Make all checks payable to this column and don't mention it to a soul.

But seriously, how about cranking up the rig down there this winter and seeing if you can't scare up some of the old gang?

## Where:

And still these new places crop up! Just when we thought the limit had been reached by some of the big guns, fellows like W8CRA crop up with information like VQ8AS (14,130 kc., T9c) is at Solomon Island in the Chagos Archipelago, 1200 miles from Mauritius, the country his prefix indicates. So even if you have worked Mauritius, don't pass up VQ8AS just because he uses VQ8. It's another country for you . . . . And K8LHA and K8TE (both 14,080 kc., T9c) are on at Wake Island, and have been giving many a new country. They need Europe for WAC . . . . Old VK2OC is now at the Solomon Islands signing VR4OC (14,070 kc., T9), and if he has the same good signal he had in VK-land should provide many with a rare country. VR4AD (7015 or 14,030 kc., T9) gets on occasionally



THE OPERATING TABLE AT W2GVZ, RIDGEWOOD, N. J.

Pat Jessup, ex-W2AUG from the 1920 days, came back to wireless with a bang in 1934, after swearing off in 1927. An all-around op if there ever was one, Pat holds down a place in the N.N.J. traffic net every evening and manages to work plenty of DX on weekends. Separate rigs on 80, 40, and 20, are used, with 1 KW on 80 and 750 watts on the other two bands. A 33-foot vertical is used on 20, and a 7-Mc. center-fed Hertz on the lower-frequency bands. The three transmitters all use primary keying for break-in. Pat has WAC, WAS, and 92 countries.

. . . . Another nice one, worked by W1DF, W1SZ, W2GVZ, W2CYS, W2BHW, and W2CMY, and others, is HZ5NI (14,415 kc., T6), who gives his QRA as Yves Murat, Pasni 21, Sana, Yemen (pronounced "yeah man!" when you

work him). He comes through in the early evening . . . . The address of FY8E is H. Ravin, Post Office, Cayenne, French Guiana . . . . W6ITH reports a 'phone QSO with TG1AX (14,108 kc.), another rare country. Reg says that if you work HO2U (14,140 kc., 'phone or c.w.) you will be pleased to know he is on a round-the-world ship, and he will QSL all contacts. Send cards care of P. O. Box 181, El Cerrito, Calif. . . . . The bootlegger who used the call of VS2AB when working W1DIR (reported here in August) will not be pleased to know that we have it from a reliable source that VS2AB died four years ago. Maybe this was another one . . . . W9KA would like the QRA of TG1S (14,430 kc., T7) or PF2DB (14,300 kc., T9x), VE3AHK wants to know about ZA2JB, W9TWC about PU9T, and W2JVU wants dope on F2AQ . . . . W3EVT got a little dope from NTZ2U, to the effect that the guy was aboard ship somewhere in the north Atlantic . . . . W9FRK says that B2KF was a ship off British Honduras . . . . If you've been bothered by some of these "UK" calls, you will be interested to know that the call means it is a U.S.S.R. "collective" station, whatever that is. Probably a school, club, or something . . . . W6HIP gives the QTH of PK6HR as Riords, Seroel, Netherlands New Guinea . . . . Don't let MO1A fool you. The "Moona Island" he tells you about would be around Detroit, Mich., if he were to receive mail there. We hope he'll get smart and get a license, and quit using up parts of our good bands.

## When:

A few of the gang came through on our plea for more 7-Mc. reports, and the big rub now seems to be that there aren't enough DX stations on. The band delivers though, since W2JKH worked CN8AR, CT1AR, YV5AO, YV5AA, and a flock of European, VK's and K6's . . . . W3FNM worked CN8AR and I1EC. W2IOP reports CT1AR, and W2BMX has kept a sked with ZL1GI since last April . . . . Is the old Asian gang still on 40, or have they all gone to 20?

Ten meters is back with more or less of a bang, and you'll miss some good tricks if you pass it up. ZS1C reports a QSO with ZB1C (28,600 kc.) for the first ZB-ZS on ten, as a starter . . . . W9LQ worked G, VK, ZL, VP2, and ZU, down there recently, and W1WR knocked off an HR . . . . This is the time of year to get in on the 10-meter DX, so go to it.

W9TWC, when he isn't collecting taxi driver stories, manages to get in on some good DX. Among the latest are VK4KC (14,390 kc., T9) in Papua, VS3AE (14,300 kc., T9), KA1AP (14,075 kc., T9), XU8HN (14,300 kc., T9), SU1HB (14,330 kc., T8c), VQ8AB (14,300 kc., T8), FA8DA (14,400 kc., T5), and YU7TE (14,450 kc., T7) . . . . W6ITH sends in so much good 'phone dope that it is only possible to list some of the juiciest, which includes VP7A (14,140 kc.) XU8HW (14,030 kc.), FB8AB (14,280 kc.), XZ2DY and XZ2BZ (14,335 kc.), VS2AK (14,260 kc.), PK4WS (14,100 kc.), PK2WL (14,220 kc.), VS1AI (14,042 kc.), G5NI (14,100 kc.) FT4AN (14,275 kc.), CN8AJ (14,127 kc.), CX2AK (14,130 kc.), OA4AL (14,020 kc.), VP5PZ (14,136 kc.), OQ5AA (14,065 kc.), and EA9AH (14,000 kc.). And that's only about a third of them! . . . . 'Phone dope from W1HKK/1 includes Y12BA (14,252 kc.), CN8AM (14,120 kc.), and W1OXDA (14,260 kc.) . . . . Others who report Y12BA are W2CYS, W2BMX (who logs him at 14,350 kc.), W9TWC (at 14,150 kc.), and W2GVX/1. It appears that you can look for him most anywhere . . . . W2GVX/1 worked another Y1, this one just new on the air. The call is Y12BG (14,160 kc., T7) . . . . W2IXY suggests YL2BC (14,070 kc.) and HA8N (14,130 kc.), if you need those countries on 'phone . . . . And WIAPA deserts the c.w. ranks long enough to chat awhile with PK1VM (14,100 kc.) . . . . V8TRF (14,340 kc., T9x) has been tough for many to raise, although W6HIP,

W2CYS, and others, report contacts . . . . . W1EWD, between the times he is working on his technical article for DSM, vainly calls XU8RL (14,310 kc., T9).

### What:

ZLAFK again raises the question that has probably occurred to all of you that have done much listening on the DX bands. 4FK says that, especially when conditions are poor, 'phone signals from W seem to have greater strength than c.w. signals, and we've noticed much the same thing here on Asian signals. The reason for it is that, when c.w. signals have a tendency to be hollow and acquire tails, a 'phone signal will fill in the gaps caused by the fade because the receiving operator unconsciously supplies the missing syllables. So, if there is no selective fading you can probably work weaker signals on c.w., but when bad selective fading sets in, 'phone pulls through better.

Or don't you agree?

### Who:

Jack Berliant, W2APV, is now operating at HH5PA (14,050 kc.), while Isaacs is in Columbia. Isaacs hopes to get on with HK5PA . . . . . W1LZ can never be counted on to be idle. Some of his latest DX includes VS1AA, VS1AF, VS7RF, VR4OC, and K6TE at Wake Island . . . . . VK2CI worked STIAB at Dessie, Eritrea, on 7 Mc. The operator was in the Italian Army down there . . . . . You made a mistake if you passed up the R.S.N.I. Contest this year. LY1KK got a gold medal for first place in the Irish event and W2GVZ'S second place brought him a silver one in the foreign competition, EI2M, GI6TK, and GI5TK placed in that order for the domestic prizes . . . . . And speaking of trophies, the one W1SZ got for winning the S.A.R.R.L. contest is an absolute knockout. Why don't things like that happen to us? . . . . . W5KC suggests that a Scott's Postage Stamp Catalogue is very helpful if you have trouble locating countries. Which would be a good spot to plug also the A.R.R.L. Map, wouldn't it? . . . . . For some of the DX stations looking for North Dakota for WAS, W2IOP suggests W9ZOP on 20 and W9ZOU on 40; and W5EKV (14,365 kc.) will be glad to give you Mississippi . . . . . The low power lads are still right in there and knocking over some pretty good stuff. One who is coming along right well is W9PNE, whose 45's recently accounted for VK7, ZL, ZS and FBAD in one morning. He has been hearing J5CC and VS7RF but no luck so far . . . . . Then there's W6KJV, whose 35 watts to an 802 final has given him WAC and some swell reports. He uses a simplified Collins coupler to tie in his 80-meter Zepp, and thinks it is the cold dope . . . . . And W4EIT, with a single 6L6 oscillator on 7 Mc., has worked a flock of Europeans and all U. S. but Idaho . . . . . Speaking of DX rag chews, AC4YN, FN1C, and VU2LK, all qualified for the RCC at the same time by a three-way QSO that lasted 2 hours and 30 minutes. Oh well, we aren't really interested in DX—much!

### Wac:

F3JD made a 'phone WAC in three hours, working W4TZ, VU2CQ, HB9CB, PY2DK and CN8AJ . . . . . W8QQE worked five continents within 24 hours after he had received his license in the mail, and worked J2IN 14 days later for his WAC! Paul's first contact in ham radio was with YR5AA, one hour after receiving his ticket . . . . . Latest 'phone WAC's go to PK1GL, PK4DG, 11KS, W6OCH, W6FZQ, PAOGN and ZS1B . . . . . Don't forget that you can get those 28-Mc. endorsements for your WAC certificate. See last month's I.A.R.U. column.

—W1JPE

## Briefs

The Schenectady Amateur Radio Association will hold its Annual Hamfest on October 2d at the Hotel Mohawk, Schenectady, N. Y. Registration begins at 10:00 A.M., program starts at 1:00 P.M. and continues throughout the evening. Fee, \$1.75 in advance, \$2.00 at the door. A good time is assured.

The Fourth Annual Hamfest of the Federation of Long Island Radio Clubs will be held at the Bethpage Country Club, Bethpage State Park, Farmingdale, L. I., Sunday, October 3d. It will be an all-day affair with 56-Mc. hidden transmitter hunt, ball games, polo match, golf, technical contests, movies and bridge for the YL's, technical



W4BRB/3 IN THE BOW OF COAST GUARD SURF-BOAT CHASING THE GREAT BEAR ACROSS THE FINISH LINE AS IT WON THE WORLD'S CHAMPIONSHIP IN MOTHBOAT RACES

talks and other interesting items. A banquet will top off the day, with prizes and dancing. Dinner tickets are \$2.00 per person. Don't miss this gala get-together—come early, stay late!

Four hours, 35 minutes is the duration of a rag-chew claimed by W9WPA and W9YDZ, both R.C.C. members!

While swimming at Crystal Lake, near Springfield, Ohio, W8QIS/W3CLQ called CQ under water by knocking together a couple of rocks—just to see how it sounded. He called several times, then signed. Several seconds later he heard W8HTI calling him with an S9-plus under water signal and a 100% QSO resulted! W8HTI was ½ mile distant on the other side of the lake.

During the V.F.W. encampment in Buffalo, N. Y., 56 Mc. was used by W8RV, mobile, W8NOR, portable, and a receiver in a motorcycle side car for dispatches to the parade and other activities. W8IHG and W8IOW, with the Sea Scout base radio station, W8QBU, also helped out. W8PSX, QBD, QEE and PUX also did a good bit of relief work. Amateur radio was used as the official communication channel for news reporters and once to summon an ambulance for first aid.

## DX Schedules

W9VDQ, 7522 Paxton Ave., Chicago, maintains 14-Mc. schedules with K6OJG, Guam, on Monday, Wednesday and Friday, 7:30 A.M. EST, and invites traffic for P.I., Guam, etc. K6OJG schedules XU8RL. W9VDQ has been handling considerable traffic from the Yankee, WCFT, and the Restorer, WCDB.

W3QP, on 14,304 kc., schedules K5AA, 10:00 P.M. EST, daily except Sat. and Sun.; K6BNR, 10:45 P.M. EST, daily except Sat. and Sun.; OA4U, 8:00 P.M., EST, Monday and Friday; VK6MO, 5:00 A.M. EST, Tuesday.

## O.R.S.-O.P.S. Results

The July quarterly activities were highly successful, the relative standings in the Relay Station and Phone Station groups as indicated below. The summer O.R.S. Party rules emphasized the possibilities of all-band work, and under the special scoring system tried the scores approached a possible "million" points! In the O.P.S. tests W6ITH made a new high scoring mark, and W8LUQ relinquished his thrice-held leadership of the operating activity for the first time. Both organization groups look forward to a new all-season competition, to be announced in October bulletins to appointees, with details on the October station tests.

### OFFICIAL RELAY STATION SCORES

Station	QSOs	Sec-tions*	Heard	Score	Power	Section
W1AW (Hal)	77/51/1	62	30	852016	120/200	Conn.
W4NC	54/62/14	71	5+2	787897	375	N. C.
W1TS	9/51/62	69	18	738654	....	Conn.
W6KFC	49/38/10	64	24	685026	150/50	Ariz.
W3AMR	69/53/4	59	22+22	627874	100/450	E. Pa.
W7GEE	48/25/15	63	16	581856	120	U.-Wyo.
W5DXA	50/31	59	12	565267	225	No. Tex.
W2DXO	55/41/12	62	20	507444	300	N. Y. C.-L. I.
W3GKZ	48/31/9	56	19	387904	200	Md.-Del.-D. C.
W8LII	8/46/46	65	30	353350	100	W. Va.

Call	QSOs	Power	Score
W5FJY	47/22	180	326,760
W6IOX	45/7/6	280	313,216
W6CIS	36/17/5	400	302,016
W8OFO	39/38	250/400	298,680
W1AEB	64/29/8	175	280,860
W2GVZ	61/15/16	650/300	264,570
W5BAM	41/4/8	60	248,780
VE4CE	26/12/8	60-100	245,400
VE5HP	28/21/12	1000	235,440
W4APU	40/25/16	200/300	228,400
W1BFT	55/33/7	500/50	214,866
W2HMJ	44/7	300	191,168
W2HJB	43/13	50/100	181,675
W1UE	61/16	50	160,848
W8GUF	33/27	100	156,706
W3FSP	36/29/4	35/65	137,600
W5CEZ	40/5	400	137,157
W2AHC	26/22/14	350/600	125,632
W6LMZ	26/9/7	150	100,914
W5GHF	12/33	125	100,804

\* Multiplier this time includes duplicated Sections.

### OFFICIAL PHONE STATION SCORES

Station	QSOs	Sec-tions	Heard	Score	Power	Section
W6ITH	32 + 7	22	11	4664	1000/100	E. Bay Conn.
W1IMV	37 + 1	17	7	3468	100/95	Conn.
W3FVQ	32	18	4	3024	475	E. Pa.
W8LUQ	32 + 1	15	15	2925	400	W. N. Y.
W8MBW	28	18	11	2916	400	W. N. Y.
W2HNP	33	17	3	2907	380	N. N. J.
W9TTA	31 + 1	16	6	2752	200	Indiana
W2LV	26 + 1	15	3	2115	750	N. N. J.
W8MOL	25 + 2	14	7	2083	400	W. Va.
W3EZ	24	15	8	2040	30	E. Pa.

Call	QSOs	Power	Score	Call	QSOs	Power	Score
W8HFR	23	250	1644	W8MOP	16	150	1000
W1DWP	20	150	1540	W1IVU	12	40	864
W8BTP	21	400	1430	W3FGJ	15 + 1	450	828
W8JFC	21	100	1380	W3AJJ	13 + 1	180	810
W6KBT	16 + 1	400	1365	W3EEL	14	175	720
W8CGU	20	200	1296	W9AEZ	7 + 1	200	630
W1EAO	18	150	1160	W8PFM	12	90	574
W8MAD	18	150	1122	W2IKV	13	200	552
W2AVS	19 + 1	50	1104	W8TYI	12 + 1	100	539
W4CYB	16	250	1040	W4BYA	11 + 1	200	520
VE3EM	16 + 1	200	1001	W8BQA	12	90	504

## A.R.R.L. Official Broadcasting Stations

The following listed stations address information regularly "to all amateurs" rendering a distinct service to fellow amateurs. First information on changes in F.C.C. regulations, new data on expeditions, special tests and activities, DX conditions and records of prime interest to the amateur world reaches amateurs first through the medium of League weekly broadcasts and the latest-revised list of stations that follows. Stations in all districts assure good coverage on the information which in many cases is so well sent it is used for code practise. Listen for the "QST" from these stations. Report results to the stations you copy too, so the operators will know their signals are successfully received and appreciated.

W1APK, W1AQL, W1AU, W1AW, W1BEF, W1BVR, W1BWY, W1FFL, W1GAE, W1GZL, W1HKK, W1JYE, W1JZN, W1KFN, W1WR.

W2ACY, W2AZV, W2FF, W2IOP, W2JGC, W2JHB, W2KKB, W2SN.

W3AEJ, W3AOJ, W3AQN, W3BBV, W3BGD, W3BIR, W3BWT, W3DNU, W3EXW, W3FPW, W3GPC, W3UVA, W4AXP, W4BQD, W4CE, W4CZA, W4DGS, W4DHG, W4EEE, W4ZH.

W5BLQ, W5CJB/1, W5DAQ, W5DKR, W5DPX, W5FPW, W5FSK, W5FZJ.

W6AM, W6BRI/CDU, W6CIZ, W6FBW, W6GZY, W6ITH, W6JTV, W6MQS, W6NMT.

W7BDD, W7COH, W7ECC, W7FL.

W8AQ, W8DLG, W8DME, W8DZO, W8DZY, W8EWP, W8GJM, W8IOH, W8JQE, W8JTW, W8MIW, W8NDE, W8NQS, W8NW, W8NYY, W8PMB, W8WE.

W9ACU, W9CWX, W9CWW, W9DEI, W9DUD, W9EDW, W9FNK, W9GBQ, W9GFA, W9HPQ, W9HUX, W9IYL, W9JAW, W9JO, W9KEI, W9NGZ, W9NUF, W9PWU, W9PZU, W9RH, W9RUJ, W9RZA, W9SYJ, W9UEU.

VE2EE, VE3AHK, VE3KR.

### MacGregor Arctic Expedition

At 7:00 P.M. EST, August 17th, W8ITK worked W1OXAB, the Schooner *Greely* of the MacGregor Arctic Expedition, on 14 Mc. and had the pleasure of taking the first ham traffic from the party, ten messages to the folks back in the states. W1OXAB was on approximately 14,360 kc. and operator Sayre, W2QY, advised that he had had no luck at all in raising hams while using call W1OXAB on 12,862 kc. or 17,310 kc. He also reported that he was using the ship call WAWG considerably on 12,460 and 16,580 kc. The expedition's QTH on August 17th was approximately 73 degrees north, near Thule, Greenland. They expected to reach their base within the next two weeks and set up permanent equipment for the duration of their stay. W1OXAB uses 600 watts input and W8ITK reports an FB T9x signal. W2QY requests that east coast amateurs listen for him on the frequencies mentioned. W3QP is attempting a twice-weekly schedule with WAWG at the request of the Carnegie Institute, Dept. of Terrestrial Magnetism.

### 1.75-Mc. 'Phone Emergency Nets

Organization of emergency nets on the 1.75-Mc. 'phone band is under way in a number of eastern and central states. In Ohio W8PUN (Chillicothe) is Net Control Station of a group which operates between 1885 and 1888 kc. each Tuesday night at 11:00 P.M. EST. Included in the roster are W8MGN, Cincinnati; W8LAX, Dayton; W8LSL, Zanesville; W8OZX, Toledo. W8NZU, Muskegon, Michigan, is N.C.S. of the stations in that state. W8MMV, New Hartford, N. Y., is member of a group which includes W8ISX, W8ITN, W1AXL, W1KKY, W8FPC, W2JSQ and W8CGU; CGU is usually on 3.9 Mc., the rest on "160." This group conducts tests each Monday and Wednesday night. Additional members are desired in N.Y.C. and Syracuse. Get in touch with W8MMV for further details.

## BRASS POUNDERS' LEAGUE

(July 15th-August 16th)

Call	Orig.	Del.	Rel.	Extra Del. Credit	Total
W6IOX	26	61	620	52	759
W6ITH	87	189	294	174	744
W4PL	2	31	474	31	538

### MORE-THAN-ONE-OPERATOR STATIONS

Call	Orig.	Del.	Rel.	Extra Del. Credit	Total
K6QGD	212	212	1640	175	2239
W50W	255	331	336	319	1244

These stations "make" the B.P.L. with total of 500 or over. One hundred deliveries + Ex. Del. Credits also rate B.P.L. standing. The following one-operator stations make the B.P.L. on deliveries. Deliveries counted

W6QBJ, 412	VE5EP, 168	W3SN, 123
W3EHW, 235	VE5SW, 162	W1IHI, 121
W6MLJ, 236	W5EGP, 154	W3QP, 120
W6IMI, 222	W7EBQ, 150	VE5DJ, 112
W6CLZ, 202	W5PCJ, 144	W61BB, 107
W6RJ, 194	K6NCD, 135	W3GLQ, 103
	W63TV, 128	

A.A.R.S.

Call	Orig.	Del.	Rel.	Extra Del. Credit	Total
WLMC (W3DQN)	19	58	895	29	991

WLMI (W6GXM) made the B.P.L. on 214 message deliveries.

### MORE-THAN-ONE-OPERATOR STATIONS

Call	Orig.	Del.	Rel.	Extra Del. Credit	Total
WLM (W3CXL)	99	47	814	—	960

A total of 500 or more, or 100 deliveries Ex. D. Cr. will put you in line for a place in the B.P.L.

## More 20-Year Club Members

THE 20-Year Club applications are rolling in so fast it is impossible to present the dope on each Old Timer "all in one issue" of QST. Instead we'll list each month the call letters of new members, plus as many "write-ups" as there is room for, in time (we hope) using all the write-ups submitted. Here are the new candidates: W1AJ W1DMF W1EAO W1ES W1FJE W1JFN W2AX W2BR W2CJX W2DZA W2EC W2IZ W2JRG W2PF W3AVJ W3BO W3BZ W3CA W3DRO W3FLH W3GPA W3JL W4CZN W4WD/W5FSI W5ERJ W6GM W6LM W6IT W6MMB W6VU W7COH W7DZY W7GCO W8FRY W8GYR W8KHM W8QKQ W8ZS W9CS W9DAX W9DGM W9FRC W9VKF W9WTE W9WZE W9VV VE3UX.

## 1.75-Mc. Stations Needed to Send Code Practice

Many beginning amateurs find "learning the code" their greatest stumbling block. They call upon licensed amateurs to help them master the dots and dashes but often there are chaps who are unable to get in touch with nearby hams. Each active radio season A.R.R.L. sponsors a program of Code Practice on the "160 meter" band. Operators working on this band are invited to cooperate in this worthwhile work. We were all beginners once and, if we will but think back, we will recall that assistance in getting started was quite welcome. During the past several years the 1.75-Mc. stations sending code lessons have helped hundreds learn the code. This season we would like to have more stations engaged in our program. Just send us the schedule you will follow in sending code practice, being sure to give your frequency (as near exact as possible) and hours and days you will transmit. We will then send you some hints on how to conduct code practice by radio. The schedules of all 1.75-Mc. code practice stations are mailed to each would-be amateur requesting same—and hundreds of these requests are filed yearly. What say, fellows? Will you lend a hand?

W2DSH, Arlington, S. I., N. Y., is the first code practice volunteer of the '37-'38 season. He will start lessons on October 7th on 1833 kc. using both voice and code, voice

for announcements. Transmissions will be from 7:00 to 8:00 p.m. EST every Thursday (except holidays). Let's have many more volunteers!

## Amateurs Handle U.S.S. Augusta Traffic

One of the biggest thrills recently enjoyed by radio amateurs was the handling of amateur 14-Mc. traffic originating with the U.S.S. *Augusta* (Shanghai, China) shortly after the much publicized shelling of that vessel. Routing was via XU8LR-K6QJG-W6DOB-W3HN. Traffic via this route was coming the whole length of the circuit at one time in eighteen minutes.

VE5GS found the QST article on PITC, Pitcairn Island, of particular interest. While operating GCSV, RMS *Matara*, he worked PITC and, on the same voyage, met two of the operators, Warren and Young.

## ELECTION NOTICES

To all A.R.R.L. Members residing in the Sections listed below: (The list gives the Sections, closing date for receipt of nominating petitions for Section Manager, the name of the present incumbent and the date of expiration of his term of office.) This notice supersedes previous notices.

In cases where no valid nominating petitions have been received from A.R.R.L. members residing in the different Sections in response to our previous notices, the closing dates for receipt of nominating petitions are set ahead to the dates given herewith. In the absence of nominating petitions from Members of a Section, the incumbent continues to hold his official position and carry on the work of the Section subject, of course, to the filing of proper nominating petitions and the holding of an election by ballot or as may be necessary. Petitions must be in West Hartford on or before noon of the dates specified.

Due to a resignation in the Eastern Florida Section, nominating petitions are hereby solicited for the office of Section Communications Manager in this Section and the closing date for receipt of nominations at A.R.R.L. Headquarters is herewith specified as noon, Friday, October 15, 1937.

Section	Closing Date	Present SCM	Present Term of Office Ends
Maritime *	Oct. 15, 1937	Arthur M. Crowell	June 14, 1937
Nevada	Oct. 15, 1937	Edward W. Heim	June 14, 1937
Alaska	Oct. 15, 1937	Richard J. Fox	Sept. 3, 1937
Ga.-Cuba-I. of P.-P.-R.-V. I.	Oct. 15, 1937	Bannie L. Stewart	Dec. 14, 1937
Eastern Fla.	Oct. 15, 1937	William C. Shelton (resigned)	.....
Wisconsin	Nov. 1, 1937	E. A. Cary	Nov. 15, 1937
B. C. *	Nov. 1, 1937	Don R. Vaughan-Smith	Nov. 20, 1937
Connecticut	Nov. 15, 1937	Frederick Ellis, Jr.	Dec. 4, 1937
Western N. Y.	Nov. 15, 1937	Richard Smith	Dec. 6, 1937
San Diego	Dec. 1, 1937	Harry Ambler	Dec. 16, 1937
Southern Texas	Dec. 1, 1937	Armon O. Young	Dec. 16, 1937
Saskatchewan *	Dec. 1, 1937	Wilfred Skaffe	Dec. 16, 1937
Virginia	Jan. 3, 1938	Charles M. Waff, Jr.	Jan. 17, 1938
Alabama	Jan. 3, 1938	James F. Thompson	Jan. 17, 1938

\* In Canadian Sections nominating petitions for Section Managers must be addressed to Canadian General Manager, Alex Reid, 189 LeMay Ave., St. Lambert, Quebec. To be valid such petitions must be filed with him on or before the closing dates named.

1. You are hereby notified that an election for an A.R.R.L. Section Communications Manager for the next two year term of office is about to be held in each of these Sections in accordance with the provisions of the By-Laws.

2. The elections will take place in the different Sections immediately after the closing date for receipt of nominating petitions as given opposite the different Sections. The Ballots mailed from Headquarters will list in alphabetical sequence the names of all eligible candidates nominated for the position by A.R.R.L. members residing in the Sections concerned. Ballots will be mailed to members as of the closing dates specified above, for receipt of nominating petitions.

3. Nominating petitions from the Sections named are hereby solicited. Five or more A.R.R.L. members residing in any Section have the privilege of nominating any member of the League as candidate for Section Manager. The following form for nomination is suggested: (Place and date)

Communications Manager, A.R.R.L.  
38 La Salle Road, West Hartford, Conn.

We, the undersigned members of the A.R.R.L. residing in the ..... Section of the ..... Division hereby nominate, ..... as candidate for Section Communications Manager for this Section for the next two-year term of office.

(Five or more signatures of A.R.R.L. members are required.) The candidates and five or more signers must be League members in good standing and the petition will be thrown out as invalid. Each candidate must have been a licensed amateur operator for at least two years, and similarly, a member of the League for at least one continuous year, immediately prior to his nomination or the petition will likewise be invalidated. The complete name, ad-

dress, and station call of the candidate should be included. All such petitions must be filed at the headquarters office of the League in West Hartford, Conn., by noon of the closing date given for receipt of nominating petitions. There is no limit to the number of petitions that may be filed, but no members shall sign more than one.

4. Members are urged to take initiative immediately, filing petitions for the officials for each Section listed above. This is your opportunity to put the man of your choice in office to carry on the work of the organization in your Section.

—F. E. Handy, Communications Manager

### ELECTION RESULTS

Valid petitions nominating a single candidate as Section Manager were filed in a number of Sections, as provided in our Constitution and By-Laws, electing the following officials, the term of office starting on the date given.

Md.-Del.-D. C.	Edgar L. Hudson, W3BAK	July 15, 1937
West Virginia	C. S. Hoffmann, Jr., W8HD	Aug. 23, 1937
Oklahoma	Carter L. Simpson, W5CEZ	Aug. 23, 1937
South Carolina	Ted Ferguson, W4BQE	Aug. 25, 1937
Eastern New York	Robert E. Haight, W2LU	Sept. 16, 1937
Eastern Mass.	Sam Gross, W1IWC	Sept. 16, 1937

In the Eastern Pennsylvania Section of the Atlantic Division Mr. John Buck Morgan, W3QP, and Mr. Alex A. Polityka, Jr., W8FLA, were nominated. Mr. Morgan received 282 votes and Mr. Polityka received 87 votes. Mr. Morgan's term of office began August 11, 1937.

In the Arizona Section of the Southwestern Division Mr. Victor C. Clark, W6KFC, and Mr. John K. Oliver, W6KOL, were nominated. Mr. Clark received 29 votes and Mr. Oliver received 21 votes. Mr. Clark's term of office began August 13, 1937.

### Station Activities

#### CANADA

##### MARITIME DIVISION

**M**ARITIME—SCM, A. M. Crowell, VE1DQ—Nova Scotia: W3BTH has been visiting friends and relatives in Halifax. VE1AW will soon have the new QTH complete. FQ has been doing some nice 14-Mc. 'phone work. BC and OW will soon be heard again, the latter with her own rig on c.w. Through the kindness of Major Borrett, Station Director of C.H.N.S., several announcements of interest in connection with the convention were carried, which were much appreciated by the gang. DB is knocking 'em off on 14-Mc. c.w. DQ has been keeping the nightly contact with VE5 and W6 on 14-Mc. 'phone. JM is home on vacation from VE3 land. EC is selling his present transmitter due to having to move around a lot and is building a more portable rig. CP is still with the R.C.M.P.—Marine Division. BB has been working plenty of DX on 14-Mc. 'phone and c.w. with only 40 watts input to his pair of '46's. BH has been having many fine chats on 14-Mc. 'phone from his "Most Easterly Station on the Continent." LR still piles up the QSL cards at the local QSL Manager's. EK has been pounding the ole brass a bit for a change. GR is going strong on 3.5 and 14 Mc. KJ moved to new QTH and has the 6L6 putting out FB on 14 Mc. LT is pounding out with '47 and 6F6 on 3.5 Mc. More congrats to EA and KH who have both annexed themselves XYL's. Come on, fellows, let's have some more news for next month. Drop us a line or a buzz to any of the Halifax gang will do the trick.

##### ONTARIO DIVISION

**O**NTARIO—SCM, Fred H. B. Saxon, VE3SG—The joint picnic held by the Toronto Clubs was a real success. Over 150 hams, including two W8's from Ohio, were present with their YL's, XYL's and friends. The Hamilton Club, who won the Field Day competition in 1936, were presented with the "S.C.M.'s Trophy," which will be held by them until the 1937 winner is announced. ADB is on 14 Mc. with a Marconi DET3. OO has 50-foot masts. VE2BB is now VE3NM. Welcome to the section, "Daddy." NC visited PM and IB (Old Wally) at Weston. GT reports working plenty of DX in early morning on 14 Mc.—he is using a 59-801 Goyder rig on 3.5, 7 and 14 Mc. Yours truly and the XYL visited W8PLA for a few days. 9AL's portable has been working splendidly keeping the summer home in touch with Toronto. KM is rebuilding. AHK has been on 14-Mc. c.w. this summer and so far has G, D, ON, CX, PY, HK, FYS, VP1, VP2, VP5, YN, I, XE, CM, K5, K6, VK and ZL to his credit. A newcomer, APS, was with First Canadian Divisional Signals in France. Welcome to amateur ranks, Mac.

Traffic: VE3DH 14 SG 9 QB 2 GT 1.

### QUEBEC DIVISION

**Q**UEBEC—SCM, Stan Comach, VE2EE—We understand that AR has told the minister "I do." Congrats, Ray. CR's new job sounds swell. FG erected another mast and new antenna with DQ, LI and EE acting as helpers. DQ rewired the rig at LV and the Mayor now sports a TZ20. II of Sherbrooke was visiting Montreal recently. Allan at VO6L is putting a nice signal into this location. Ex-2BB is now VE3NM and LC is running a schedule with Daddy. GE bought a 1938 Super-Skyrider and DU now owns an ACR-175. AP has gone commercial on us and the job is keeping John very busy. CX had a very nice time over with the G's and returned on the *Queen Mary*. HH has rebuilt his rig. HT had distinguished visitors in the persons of WIKH, Vice-Pres.-A.R.R.L. and his buddy W1WV. KF has been visiting CB, GU, NL and KO. EC has a sign with his letters on the toll-bridge and has had quite a few visitors as a result. W8DGV was a visitor at DG. AY has been heard on the air again. DV is applicant for O.R.S. VE4GQ was down from Winnipeg visiting JA. IR has discarded his crutches and now gets along with a cane. Glad to hear it, Corey. JK has been working plenty of DX from his country residence. Continuing the list of calls I would like to hear from, will the following please drop me a line before the 16th October: AJ, BL, CI, DI, EO, FT, LD, MN, NX, GP, HO, IM.

Traffic: VE2HT 7 EC 51 KF 15 HH 3 LC 7 EE 5 DR 8.

### VANALTA DIVISION

**A**LBERTA—SCM, Alfred D. Kettenbach, VE4LX—AFT, new O.R.S., leads the traffic handlers. KP and LR are planning with 56 Mc. GE visited hams in Hanna; he is now W.A.S. CT is working 14 Mc. EX, Edmonton's YL ham, married Aug. 14th and will live in Calgary. BF is rebuilding shack. EA gave the Edmonton Club a talk on new B.C.L. receivers. FR is building new rig for 14 Mc. HM will visit the Headquarters gang at W. Hartford. HJ is pleased with the successful winding up of the hamfest business. LQ snagged K6 in Guam. MR is talking of putting in a single '10 in place of his 112's. QX has exciter unit of new rig on the air. UY is heard on 14 Mc. ZP is having fine time cruising Northland with United Air Transport. ABH is visiting in B.C. AEN installed keying oscillator. AGZ is on the air at last.

Traffic: VE4AFT 18 GE 9 WX 4 LQ-QK 2.

**BRITISH COLUMBIA**—SCM, D. R. Vaughan-Smith, VE5EP—SW made B.P.L. in schedule with Victoria Y Camp station, 51C at Glinz Lake. HP made a super score in July O.R.S. Party. JL and OK are comm. ops. on the local coast service. AX pulled the pins for England. ZLIBB and the stooge at 1KJ were visitors in July. AT is proud possessor of an XYL and is living at Hazelton. AE superintending the installation of Airways station at Grand Forks. MJ kicks around nicely with a bare 14 watts. ABK is the station of the Ontario School Boys' Expedition to Northern B.C. GF has his 14-Mc. 'phone nearly finished. KQ is 2nd op. on *Empress of Russia*. ND keeps his bro., EO, in touch with civilization. NP and ABA are new stations on the 3.9-Mc. band. NG has her rig working nicely and will soon be on 14 Mc. BI has fun with a half-watt peanut tube portable. The VE5 gang mourn the passing of Floyd Scobee, WTFBC, whose home was in Vancouver.

Traffic: VE5SW 210 DJ 418 IC 372 EP 217 BJ 20 DL 2 CE 8 AAE 22 UK 19.

### PRAIRIE DIVISION

**M**ANITOBA—SCM, A. J. R. Simpson, VE4BG—AAW spent his vacation with the W9's down in Minneapolis. IP returned from California with a new Breting receiver. GL brought back a new Hallicrafter receiver from across the line. OK is on 14 Mc. with Class B T20's in P.P. W6KOP from Salt Lake City was a guest at ZK. ZK's first QSO was with 6KOP and weekly schedules have been maintained without interruption for three years. UX, who has been up North at Rankin Inlet operating under VE5AAY, is installed at the Flin Flon and will probably be heard soon under his old call UX. Other news from the North country is that MW had the gas engine used for driving his generators catch fire and the radio shack burned down to the ground. QF is still pounding brass for the mine at Island Lake. RO.

(Continued on page 100)



# CORRESPONDENCE

The Publishers of QST assume no responsibility for statements made herein by correspondents

## A New Sub-Division Plan

21 Rockview Ave., N. Plainfield, N.J.

Editor, QST:

The problem of improving our system of frequency allocations and operating methods is both interesting and difficult. It seems to me that the French proposal is not suited to our requirements in this country and holds a real danger to us all. Due to the large number of amateurs in this country, we must utilize every kilocycle on the popular bands such as 3.5, 7.0 and 14 Mc. If we do not, some foreign government will sooner or later point to our "successful" operations in  $\frac{2}{3}$  of a band and say, "Let us put the rest of the world in there, too; a few more won't hurt."

Zoning has its points, but only if the bands are completely occupied by us Yanks. This may seem selfish at first glance but I think it plain horse sense for the reason given.

As your recent editorial threw this whole subject wide open, may I toss in the following suggestions. They will inconvenience a good many amateurs in some degree if carried out, but I feel that they will prove immensely beneficial to the game in providing better operating conditions. They will also test every amateur's skill as they will require him to be reasonably versatile in his radio operation:

1. Abolish 1.7-2.0-Mc. 'phone.

Any service that causes 67 per cent of the public's complaints against amateurs should be eliminated if possible.

2. Abolish the Class "A" license.

"How to build it" 'phone dope is now widely available. The man with a retentive memory and a license manual is given a bonus over his more methodical brother.

3. Devote the 1.7-2.0-Mc. band to Mr. Handy's traffic organization.

This band is ideally suited to a great portion of the short-haul traffic work, c.w. only.

4. Assign 3.8-4.0-Mc. to c.w. exclusively for long distance traffic nets.

These frequencies are only harmonically related to the 1.7-Mc. band. This would give a total of 485 kc. for the use of traffic men. At present they are using less than 400 kc. for all practical purposes.

5. Leave the 28-Mc. (modified) and 56-Mc. assignments alone.

6. Make the remaining portion of 3.5-4.0

(3.5-3.8) Mc. exclusively for 'phone for one month and make this assignment completely c.w. the following month.

7. Do the same thing to the 7.0-7.3-Mc. assignment. (Perhaps we can secure the co-operation of the foreigners to stay off 'phone during the c.w. months).

8. Do the same thing to the 14.0-14.4-Mc. assignment (no c.w. busting up 'phone and vice-versa).

Suppose it is set up like this:

	3.5-3.9 Mc.	7.0-7.3 Mc.	14.0-14.4 Mc.
Jan.	c.w.	'phone	c.w.
Feb.	'phone	c.w.	'phone
Mar.	c.w.	'phone	c.w.
Apr.	'phone	c.w.	'phone

The advantages of this plan that occur to me are as follows: B.C.L. complaints would be reduced in number. Our traffic handlers would be provided ample facilities to carry out their activities with less trouble than they now have. Either one or the other of the DX bands would always be available for c.w. The same would also be true of 'phone. The 3.5-3.8-Mc. section would also alternate every month between the two types of service. A man with a 7-Mc. sked. could hook on a modulator in the A3 months, or shift to 20 if he must pound brass. The 'phone boys on 1.7-3.9 and 14 Mc. at present could likewise shift to the key or shift bands. The plan will not inconvenience the progressive amateurs that are equally at home on both 'phone and c.w. on several bands. This type of amateur is unquestionably the best because of his versatility, and amateur radio can be improved if his number is increased. Our DX contest would have to be revamped but that should be an easy job for the Hq gang. The prospect of a whole band full of 'phone with some elbow room, or one full of c.w. without "How's my modulation?" or its French, Spanish or Portuguese equivalent would be decidedly worth while.

The plan is easily enforced. If someone starts an A3 CQ on a band devoted to A1 (of course, we all listen before we transmit) he will soon wake up. A period of a month makes it reasonably sure that at least one DX "hot spot" will take place (every 21 days, isn't it?). While some slight confusion may occur at the end of the period, if the hour is set at 3:00 a.m. local time little trouble will occur as the bands are quite dead at this hour.

In closing, I would like to say that I have tried

to examine the entire amateur's picture impartially and fairly. It is really more than a one-man job as evidenced by the appointment of the new engineering committee. I do believe it is basically sound but it is up to you and the gang to discuss and find its weak spots. Those that object to every change as a matter of principle, or because of selfish interests, should bear in mind that our present practice will be changed before long. It behooves us to examine every possibility carefully so that when the change takes place it will provide "the greatest good for the greatest number."

—D. A. Griffin, W2AOE

## Silent Pirates

Mayaguez, P. R.

Editor, *QST*:

Oh, yes, dear Editor, K4RJ, K4KD, K4BRN, K4DTH and yours truly have been laughing this week—ho ho ho and a bottle of rum! There is a bunch of Class C K4's that in some funny way got their tickets because they cannot send and receive the reglamentary 13 wpm as far as I know, and who operate in the 3.9-4.0-Mc. 'phone band on 'phone communication between themselves and the Dominican Republic amateurs who answer on 7-Mc. 'phone.

Early this week there arrived at San Juan two engineers of the F.C.C. and when the boys read the news in the papers they went QRT and the band is dead now until the F.C.C. representatives go back to the U.S.A.

This is really pitiful because these chaps were having a very interesting game and now they must QRX for a while. Oh, yes, they don't care for 160 meters at all.

—Luis Gandia, Jr., K4BU

## Rotten QRM

Milford, Neb.

Editor, *QST*:

W2GCC draws an S9 plus for his letter in August *QST*! Forgetting the desire for increased space, consider our crowded amateur bands from a practical view. Every band, day or night, carries probably 75 per cent of traffic which could best be carried on a different band, or in a different manner. Listen on the 'phone bands; you'll hear cross-town duplex, fully-modulated 100- to 500-watt carriers doing the job. Listen to the boys on 14-Mc. visiting someone a few blocks away, their sigs riding thousands of useless QRMing miles. The stupid operating is really the cain-raiser fellows; simple common sense is the answer to more pleasant amateur radio. Common faults, both 'phone and c.w. include: useless and unnecessary testing, with power right into the antenna; calls much too long, with not enough break-in used; failure to examine often and to operate upon the transmitting frequency as much as possible.

Now another thing. We have seen jealousy and general cussedness try to knock our League. It is up to us members to do a little missionary work on our own. Few of us do much plugging for our A.R.R.L. We leave that to *QST*. Incidentally *QST* is doing a real job—witness our increased growth and strength. But don't forget, fellows, many newcomers if invited to join our organization (in this way becoming full-fledged amateurs!) with just a little sales talk are glad to come in. Don't feel bashful about letting the world know you're a League member, and proud of it!

*QST* will keep hammering for better operating technique, but as we operate from day to day we should regard as our duty the dropping of occasional well-placed suggestions in the way of improved operation. Straight technical information is as free as air compared with the days when it was nearly all self-instruction, but sensible, practical operation doesn't come out of books.

—B. H. Hansen, W9GDB

## Telephone Directory Listings

47 Lynwood Ave., Wheeling, W. Va.

Editor, *QST*:

On August 17, W8BOW, Wheeling, W. Va., with that inquisitive eye the majority of hams have, approached the

local Bell Telephone office, asking if his amateur call letters could not also be listed in the new 'phone books just being published, in view of the fact that private line telephone subscribers were given two listings in the book free of charge.

The local clerk stated there had been no ruling upon that question as yet, and asked the manager. The manager agreed, and proceeded to call the principal offices in the state, at Charleston. After the QSO between the managers, the word was that Charleston had no ruling upon such a matter either, and that Charleston referred the local manager to the principal office of the Bell System, in New York City. Whereupon another LD QSO ensued, to the utter amazement of W8BOW! When New York City was on the wire, the Wheeling end was advised that no ruling had ever been made upon that feature, and that a special meeting would have to be called the following day to pass upon it! W8BOW went home, amazed at the telephone officials' freedom in making DX QSOs on the wire, and wondering, too, what he had begun.

The following afternoon W8BOW was called by the local Manager and advised that a ruling had been made at a meeting in New York City. The ruling was that when a subscriber to a private telephone line was a radio amateur, his amateur station call would also be listed (besides the name listing), if requested, free of charge. The listing would be as follows: "Radio Amateur W8XYZ" and the 'phone number.

In the event of another traffic jam like the one just concluded here, caused by hams bolting into the telephone office, the police department may threaten to have a radio car from W10XGE, and a squad of cops around to control the QRM!

But, joking aside, this ruling is quite important, as it will be nation-wide in its scope, and will be of special benefit in districts subject to periodic emergencies in which amateur radio has demonstrated such a tremendous value.

—C. S. Hoffmann, Jr., W8HD

**Editor's Note.**—Although apparently still not widely realized by amateurs, the A.T. & T. ruling cited above has been in effect for nearly two years. In some cities the "Radio Amateur Station" columns in the telephone directories have reached appreciable proportions.

## Try It

1345 East 66th St., Cleveland, Ohio

Editor, *QST*:

For the past few months there seems to be a renewed attempt to kick the high power boy in the pants. Any amateur will admit that he would run a kilowatt himself if he had the money. However, as long as a fellow has to be content with low power, why not make the most of it instead of complaining? The power here is about 60 watts and I get a real thrill when I sit down and receive a report that I am coming in FB on the west coast. I know several low-power fellows who get out on a par with the kw. stations. What I am leading up to is that if the complainers would do a little experimenting and sensible operation they too would come out on top. Come on, fellows, try it.

—Russ F. Sievert, W8OZA

## A Word to the Unwise

Elyria, Ohio

Editor, *QST*:

I had just rebuilt my rig. It worked FB. Spent all my cash and had a borrowed r.f. ammeter in the rig at the time. Like 90 per cent of the hams do, I left the antenna on when the rig was not in use. This during the summer when electrical storms are apt to come up at any time. Result: The lightning scored a perfect hit—nothing left. Sangamos went up like firecrackers. I'm glad I wasn't near and that the house didn't burn down. But it looks like I'll be off the air for some time.

—J. H. Crumley, W8LXX

(Continued on page 58)



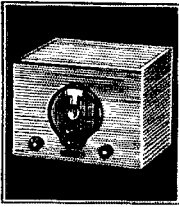

It is now six years since we first began making SW-3 Receivers. We still make them.

There is no need to discuss the merits of these little receivers at this late date, for they are now part of the history of amateur radio. They have become the workhorse of the short waves; you see them everywhere in general, and in tough spots in particular. When W8DPY set out on that desperate flood-emergency expedition that was destined to win the Paley Award, he took his SW-3. When Byrd isolated himself in that Antarctic hut for the long winter season, he took an SW-3. Thumb back through the pages of the National Geographic Magazine and check off the long list of expeditions to the far corners of the earth, that had to have reliable communication. . . . Ten to one that receiver back in the shadows of the tent is an SW-3.

Many changes have taken place in the six years since the little SW-3 first made its bow. The RAC transmitter is gone, and crystal control has become commonplace. Receivers have gone superhet, with hairline crystal-filter selectivity, to cope with badly crowded amateur bands. Amateur shacks are crowded with all kinds of new-fangled gear these days, but there is still always room for the SW-3. Maybe they are there just in case . . . (There *might* be a flood in this valley!) Maybe it's because the darn things *do* pull in the signals still, somehow or other. Maybe it's just sentiment, the gruff affection they always seem to win from the men who use them long and hard.

We feel that same affection for them, too. That is why we like to talk about them. But what we really started to say was something else again. We have some half dozen different receivers listed in our catalogues ranging widely in performance and in price. But all of them have one thing in common with the SW-3; there is a certain no-nonsense efficiency about them that makes friends and keeps them. You may not be going to Ak-Bulak to observe an eclipse, but wherever they go these National Receivers serve just as faithfully as the SW-3 has, as the new NC-80 will.

That is why their resale value is so cockeyed high. National Receivers just don't change ownership.

JAMES MILLEN



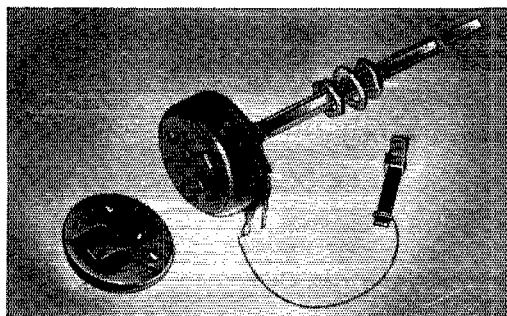

## YAXLEY SILENT Volume Controls

**T**HERE are two reasons why you should use Yaxley Volume Controls in your phone rig.

First . . . these controls are built with the famous Yaxley SILENT construction. You can use Yaxley Controls in high-gain preamplifiers where the slightest noise would be amplified a thousand-fold.

Second . . . Yaxley Volume Controls are available in the Yaxley No. 1 taper which provides an approximately linear decibel attenuation, thus giving an added convenience in adjusting your transmitter.

Yaxley SILENT carbon element controls are available in different tapers with resistance values from 5,000 ohms to 9 megohms. Yaxley wire wound controls are made in a resistance range from 1/2 ohm to 150,000 ohms.

See Yaxley Volume Controls at your distributor's.

**P. R. MALLORY & CO., Inc.**  
**INDIANAPOLIS INDIANA**  
Cable Address—PELMALLO



## Correspondence Dept.

(Continued from page 54)

### Radio Strip Poker

184 So. Main St., Manchester, Conn.

Editor, *QST*:

I think W6NIF has a FB idea with his radio poker scheme, but may I add that instead of playing conventional poker, why not strip poker? Take off 1 watt power input each time a player loses a hand. I'm sure that this will appeal to the "Flea Power" boys.

—Bill Batchelder, W1HZK

### Pse QSL, OM

4310 Evans Chapel Road, Baltimore, Md.

Editor, *QST*:

. . . . Around March 1936 I became interested in the short waves and I thought it would be very fine to start a collection of short wave verification cards including QSL cards from amateurs, and I am sorry to say it has nettled me but approximately 50 per cent of results. The amateurs are the chief offenders.

I know I have sent out reports to amateur stations numbering 500 and I have about 250 who have replied. . . . I include return postage with every request to an amateur for his QSL card, and on an average it costs me 10¢ for each request I mail. When one sends out a large number of reports and it costs 10¢ per report, it soon amounts to great expense and when only one-half reply it makes that expense greater.

I know many short wave listeners fail to enclose return postage to an amateur when asking for a QSL card and I have no use for that type. It is they who jeopardize the chances of one who does include postage. If I were an amateur I would deposit the ones without postage in the wastebasket, and answer the other 100 per cent. But it seems as if the s.w.l. who does enclose postage must suffer the same fate. From experience I know what I am saying. It seems only fair that every amateur receiving a correct report from an s.w.l., who does have the courtesy of enclosing postage, should send his card to that s.w.l. If he does not wish to send his station card, the least that can be done is to send a postcard as a reply. It would show that he is at least courteous enough to reply. But as I have said before that courtesy is distinctly lacking in the amateur operator class. The foregoing may sound harsh, but it describes my feelings and also the feelings of others who enclose postage and receive nothing in return.

I thought by joining the A.R.R.L., it would benefit my chances of receiving QSL cards, but it has not done so in the least. I belong to a South American organization, the *Rueda del Oeste*, a society founded in 1923 in Argentina, and one of the rules reads that all the members must answer all correspondence received from other members. If they fail in this they are liable to expulsion from the organization. It is a great pity that the A.R.R.L. and member societies do not have such a rule. I venture to say that if they did it would be many members being ruled out for failure to answer reports of s.w.l.'s. . . .

—Carroll H. Weyrich

3202 River Ave., Camden, N. J.

Editor, *QST*:

I would like to get the QSL situation straightened out with some s.w.l.'s. I appreciate very much all the heard cards that I receive from them and hope they continue with their FB hobby of saving QSL's. I answer 100 per cent every s.w.l. that sends me a heard report. In the Radio Amateur Call Book my QRA is printed with "All QSL's Ans'd". I mean that any ham sending me his QSL will be positive of getting mine and any s.w.l. that hears me on the air and sends me a report as to my signal strength, time and date will also get one, but some have a hobby of looking through the Call Book and sending out a card with the following "Pse QSL OM I hrd u QSA 5 on all Bands." Such and others similar to this cannot be verified.

—Joseph A. S. Werner, W3CZN

# Convertible

.... from 80-T to 700-R

The 80-T and 700-R Transmitters join hands in offering you a simple and inexpensive means of increasing power. Just return your 80-T to us for full credit when purchasing the 700-R. We convert your 80-T right into the larger unit.

**80-T** Transmitter — 1500 to 30,000 Kilocycles — Phone CW Switch — No Neutralization — Excitation Control — Antenna Matching Circuit. Nominal rated output — 18 watts phone — 80 watts CW.

**700-R** Transmitter — 1500 to 30,000 Kilocycles — Built-in Modulation Monitor — Safety Fuses and Relays — High Frequency Insulation — Unit Construction. Nominal rated output — 250 watts phone — 700 watts CW.

*Write for full details*

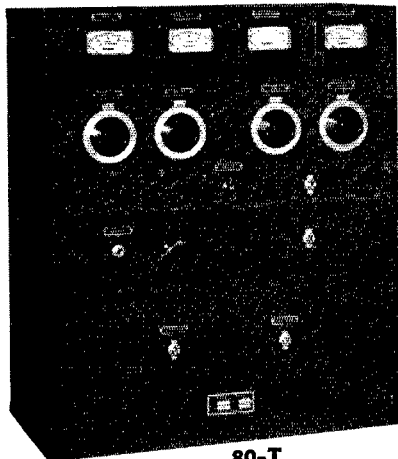

80-T



700-R

**HARVEY RADIO LABORATORIES, INC.**  
12 Boylston St., Brookline, Mass.

# THIS SEASON Start *RIGHT* with BLILEY CRYSTAL UNITS



## Type LD2 Crystal Unit

The most popular amateur crystal on the market. Drift less than 4 cycles /MC/°C. 40-80-160 meters.

TYPE LD2  
\$ **4.80**  
40-80-160 METERS



## Type HF2 Crystal Unit

Specifically designed for the higher frequency amateur bands. Simplifies 20, 10, and 5 meter transmitters.

Now  
\$ **5.75**  
30-METER BANDS



## Type VF1 Variable Frequency Unit

Frequency instantly variable up to 6KC. on the 80 meter fundamental, or 24-KC. on 20 meters.

Now  
\$ **7.50**  
80-METER BAND



## Type BC3 Crystal Unit

Four years ago this proven X-cut unit sold for \$4.95. Considerably improved, it is now available at a new low price.

Now  
\$ **3.35**  
40-80 METER BANDS

**BLILEY ELECTRIC CO.**  
ERIE, PENNA.

## Try a Little Later

205 South 3rd St., Albuquerque, N. Mex.

Editor, *QST*:

I have just finished reading Mr. R. Villanor's letter regarding "Foreign Fones," in the August issue of *QST* and I would like to add a few words from this side of the fence. In the first place I appreciate, as well as a good many other fellows I know, the fact that the "Foreign Fones" are out of the American 'phone band. While I enjoy QSO's with as many W stations as I can work, there comes the time when a little 'phone DX is a pleasure, and I ask you how could we ever hear these low-powered DX stations if they were mixed in among the kilowatt American stations? I have had a number of FB QSO's with XE2FC, as well as VK's, PK's and VE's, who were out of the American 'phone band using as low as 14 watts input. I don't think these QSO's would have been very successful had they been in the 14,150-14,250 section of the band. I am glad their governments allow them to operate where they do and hope they stay there. I am not partial to the 'phone gang as I like 20-meter c.w. and work it a lot but I usually stay away from the ends of the 'phone band and am not bothered with 'phone QRM. After all, a QSO is not so important that it can't wait until another time, unless it is QRR. Why should a fellow let a little QRM get him down? If the band is screwy, line noise is bad, or the QRM is going full blast, just pull the old big switch and try a little later.

—E. G. Bowden, W6CHU

## Standard Frequency Transmissions

Date	Schedule	Station	Date	Schedule	Station
Oct. 1	BB	W6XN	Oct. 30	BX	W6XK
	A	W9XAN	Oct. 31	C	W6XK
Oct. 2	BX	W6XK	Nov. 5	A	W6XK
Oct. 3	C	W6XK	Nov. 12	B	W9XAN
Oct. 8	A	W6XK		B	W6XK
Oct. 15	B	W9XAN	Nov. 17	C	W9XAN
	B	W6XK	Nov. 19	B	W9XAN
Oct. 20	C	W9XAN		A	W6XK
Oct. 22	B	W9XAN	Nov. 24	BB	W9XAN
	A	W6XK	Nov. 26	BB	W6XK
Oct. 27	BB	W9XAN		A	W9XAN
Oct. 29	BB	W6XK	Nov. 27	BX	W6XK
	A	W9XAN	Nov. 28	C	W6XK

## STANDARD FREQUENCY SCHEDULES

Time (p.m.)	Sched. and Freq. (kc.)		Time (p.m.)	Sched. and Freq. (kc.)	
	A	B		BB	C
8:00	3500	7000	4:00	7000	14,100
8:08	3600	7100	4:08	7100	14,100
8:16	3700	7200	4:16	7200	14,200
8:24	3800	7300	4:24	7300	14,300
8:32	3900		4:32		14,400
8:40	4000				

Time (a.m.)	Sched. and Freq. (kc.)	
	BX	
6:00	7000	
6:08	7100	
6:16	7200	
6:24	7300	

The time specified in the schedules is local standard time at the transmitting station. W9XAN uses Central Standard Time, and W6XK, Pacific Standard Time.

## TRANSMITTING PROCEDURE

The time allotted to each transmission is 8 minutes divided as follows:

- 2 minutes—QST QST QST de (station call letters).
  - 3 minutes—Characteristic letter of station followed by call letters and statement of frequency. The characteristic letter of W9XAN is "O"; and that of W6XK is "M."
  - 1 minute—Statement of frequency in kilocycles and announcement of next frequency.
  - 2 minutes—Time allowed to change to next frequency.
- W9XAN: Elgin Observatory, Elgin National Watch Company, Elgin, Ill., Frank D. Urie in charge.  
W6XK: Don Lee Broadcasting System, Los Angeles, Calif., Harold Perry in charge.

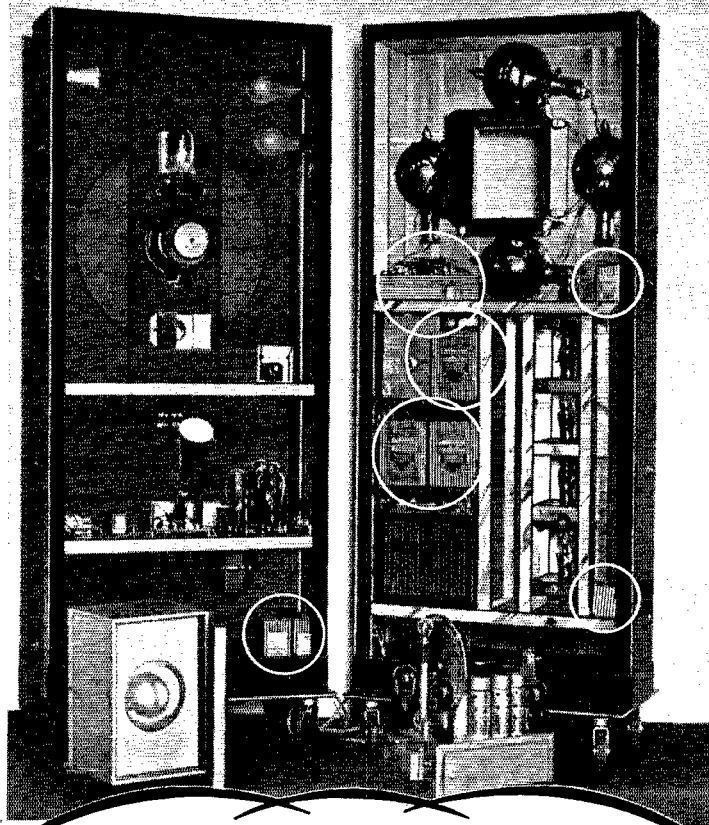

## INSIDE INFORMATION on TELEVISION

*-- discloses use of Burgess Portable Power*

Practical television has been pioneered by American Television Institute. Special machines designed by Mr. V. A. Sanabria have already given practical demonstrations in many cities of the United States.

The illustration shows the interior view of one of the new pieces of television equipment. It is significant that wherever dry batteries are used, these bat-

teries have been made by Burgess. Here again scientists depend on the name *Burgess* — a name that has always stood for the greatest service and greatest economy in this field.

You, too, will find greater satisfaction, lower over-all costs when you specify Burgess portable power.

**BURGESS BATTERY COMPANY**  
Freeport - - - Illinois

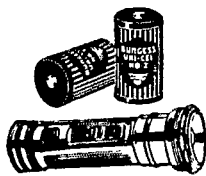

# BURGESS



Say You Saw It in *QST* — It Identifies You and Helps *QST*

**EXTRA**

# Newark News

**EXTRA**

**HAMS! SAVE MONEY! BUY AT NEWARK!**

**GREATER VALUES THAN EVER BEFORE!  
SETS AND PARTS ON EASY TERMS!  
STOCK UP NOW AND PAY LATER!  
MORE COMPLETE STOCKS!  
FASTER SERVICE!**

**ORDER NOW**

Easy terms on orders for parts, sets and tubes, \$60.00 or more. We have all the new amateur sets as soon as released by manufacturers, on our convenient 6% Credit Plan. No matter what set you want, we can furnish it. All the standard makes in stock for immediate delivery. Before you buy, WRITE.

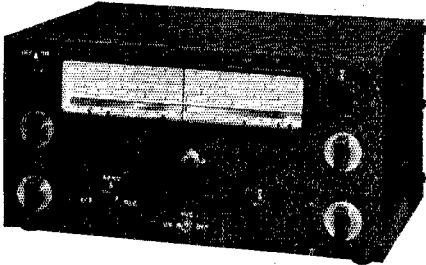

**NEW NATIONAL MODEL NC-80X**

ONLY  
**\$88<sup>00</sup>**  
Cash Price

ONLY \$18.00 Down  
\$12.68 a Mo. for 6 Mos.  
or \$8.53 a Mo. for 9 Mos.  
or \$6.44 a Mo. for 12 Mos.

(Complete with Tubes, Crystal Filter, 8" P.M. Speaker Chassis)

Ten Tubes . . . 2 Watts Undistorted Output . . . Frequency Coverage Continuous from 550 kc. to 30 mc. New I.F. Amplifier . . . Selectivity Continuously Variable between 400 cycles and 5 kc. . . Multiple Scale Dial of the full-vision type. Uses a mirror for overcoming parallax . . . For further information see the manufacturers own ad in this issue of QST.

**MODEL NC-81X — Special Amateur Model**

The NC-81X is a special amateur model with plenty of band spread. Has the same features as NC-80X but covers the following bands ONLY: 1.7-2.0 mc., 3.5-4.0 mc., 7.0-7.3 mc., 14.0-14.4 mc. and 28-30 mc. Price and payments same as above.

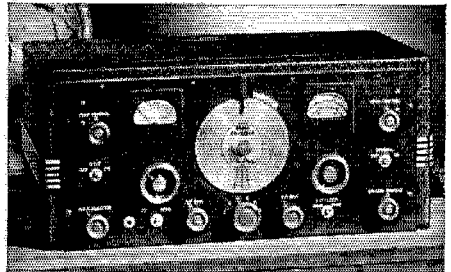

**1938 HALLCRAFTERS SUPER SKY RIDER**

**\$123<sup>00</sup>**  
Cash Price

ONLY \$23.00 Down  
\$17.74 a Mo. for 6 Mos.  
or \$11.93 a Mo. for 9 Mos.  
or \$9.02 a Mo. for 12 Mos.

Complete with Tubes,  
Crystal and Speaker

11 Tubes . . . 6 Bands . . . 5 to 550 Meters . . . Wide Range Variable Selectivity . . . Better than One Microvolt Average Sensitivity on All Bands . . . Improved Crystal Filter Control . . . 1000° Electrical Band Spread . . . "S" Meter . . . 13 Watts Undistorted Output . . . Air-Trimmed R.F. Circuit . . . Improved Expanding I.F. Transformers. (See HALLCRAFTERS Ad.)

**VERY SPECIAL** Oil Filled  
and Oil Impregnated  
**FILTER  
CONDENSERS**

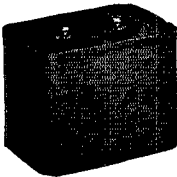

Lucky purchase of 10,000 all well known makes enables us to offer astonishing low prices. All Guaranteed at rated voltages. Already sold down to limited supply and going fast.

Order Now

1 mfd., 2000 V. DC, 5 x 3 1/4 x 1, 1 1/4 lbs.	\$1.25
2 mfd., 2000 V. DC, 4 1/4 x 3 1/4 x 1 1/4, 1 1/4 lbs.	1.50
3 mfd., 1250 V. DC, 3 1/4 x 3 1/4 x 1 1/4, 1 1/4 lbs.	1.25
8 mfd., 2000 V. DC, 5 x 3 1/4 x 3 1/4, 2 3/4 lbs.	2.75
9 mfd., 3000 V. DC, 5 1/4 x 3 1/4 x 1 1/4, 9 lbs.	7.25
(Including 2 1/2" Bakelite Standoils)	
4.4 mfd., 1500 V. DC, 5 x 3 1/4 x 1 1/4, 1 1/4 lbs.	1.75
5 mfd., 1500 V. DC, 3 1/4 x 3 1/4 x 1 1/4, 1 1/4 lbs.	1.90
5.2 mfd., 1000 V. DC, 5 x 3 1/4 x 2 1/4, 2 1/4 lbs.	1.50

**Other Receivers Available On Time**

	Cash	Down	6 Months	9 Months	12 Months
	Price	Payment	Payments	Payments	Payments
National NC-101X complete with tubes, crystal and speaker in cabinet.	\$129.00	\$24.00	\$18.55	\$12.50	\$9.47
National NC-100X complete with tubes, crystal and speaker in cabinet.	\$147.60	\$27.60	\$21.00	\$14.21	\$10.80
National NC-100 complete with tubes and speaker in cabinet.	\$125.10	\$20.10	\$18.55	\$12.50	\$9.47
National HRO with tubes and coils.	\$179.70	\$29.70	\$26.14	\$17.67	\$13.45
National HRO with tubes, coils and power supply.	\$195.60	\$35.60	\$27.84	\$18.83	\$14.33
Hammarlund Super Pro complete with tubes, crystal and 8" speaker.	\$255.70	\$35.70	\$38.08	\$25.78	\$19.64
ACR-155 complete with tubes and built in speaker.	\$74.50	\$14.50	\$11.00	\$7.39	
ACR-111 complete	\$189.50	\$39.50	\$26.14	\$17.67	\$13.45
RME-69 complete with tubes, crystal and speaker in cabinet.	\$151.20	\$26.20	\$21.94	\$14.77	\$11.25
Hallcrafters Ultra Skyriders with tubes and crystal. Speaker \$12.00 extra.	\$114.50	\$19.50	\$16.90	\$11.37	\$8.59

**NEWARK ELECTRIC COMPANY**  
226 W. MADISON ST. Dept. Q CHICAGO, ILL.

**EXTRA**

# Newark News

**EXTRA****NEWARK IS HEADQUARTERS FOR**

# Taylor Tubes

**THE COMPLETE LINE ALWAYS IN STOCK**

**N**EWARK is proud of the fact that they are one of the leaders in the sales parade with the "Sales Champion" Taylor Tubes. "More Watts per Dollar" apparatus is what Newark recommends — in tubes and all other amateur Radio Equipment. Our new 1938 catalog, now ready for you, has the most complete listing of both standard lines and hard-to-get gear. . . . Send for your copy today! Remember Newark does not know what a "back-order" is! You get Four Hour Service, every time! Order your Taylor Tubes from Newark. Always a complete stock!

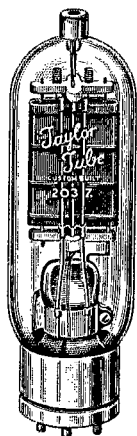
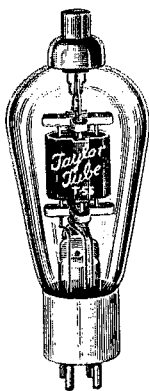
**TAYLOR TUBES SALES CHAMPIONS**

T-125	— THE NEW CARBON TANTALUM.....	\$13.50
T-20	— Real Power at low cost.....	2.45
TZ-20	— Zero Bias — 70 Watts Audio.....	2.45
T-55	— Still the Big Champ.....	8.00
T-200	— The Powerhouse Tube.....	21.50
203Z	— 300 Watts Audio — Zero Bias.....	8.50
822	— 600 Watts Audio.....	18.50
866	— Outsell all others.....	1.50
866 Jr.	— New and popular.....	1.00

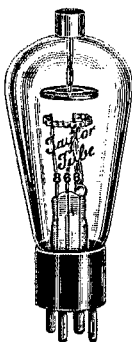
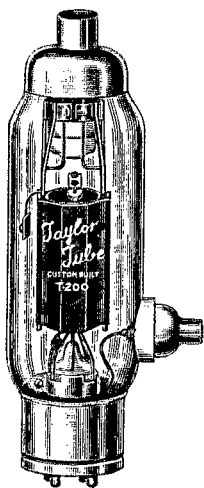

## FREE!

Get your own Call Letter Lapel Pin from NEWARK's. Let us serve you on the Taylor Tube's Lapel Pin offer. See Taylor's ad in this issue for full details.

**WRITE NOW! FREE!**

**TAYLOR TUBE MANUAL**  
and  
**NEWARK'S 1938 CATALOG**

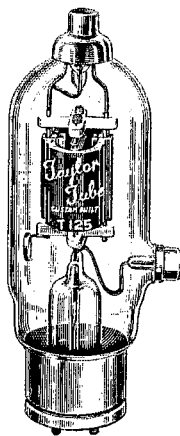
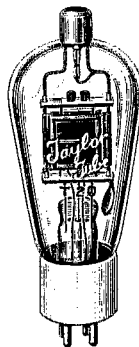

# NEWARK ELECTRIC COMPANY

226 W. MADISON ST. Dept. Q CHICAGO, ILL.

ANTENNA

LEAD IN

# IMPROVE YOUR CIRCUIT

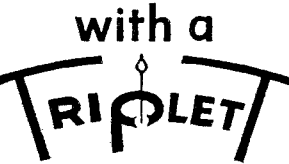

## THERMO-COUPLE

### Instrument

BUY NOW

At New Low Prices

Triplet Thermo Ammeters are characterized by long-life design and high overload capacity. When including in a circuit the Thermo Ammeter may be placed on the panel at a distance from the antenna leadin. This precludes the possibility of upsetting the circuit and the instrument is in a position where it can be conveniently read. Thermo-Couples are external to the meter and are connected to it by 2' leads. This permits use of different ranges of couples with the same instrument and easy replacement in the event of a burn-out.

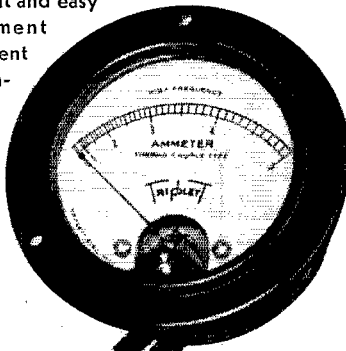

See Your Jobber

Write for More Information

For example: 2" Model 241. DEALER NET.....\$5.83  
 Thermo-Couple for All Sizes. DEALER NET.....\$2.67

Triplet Thermo Ammeters are available in 2", 3", 4" and 5" sizes

THE TRIPLET ELECTRICAL INSTRUMENT CO.  
 2510 Harmon Avenue, Bluffton, Ohio

Without obligation please send me more information on Triplet Thermo-Couple Instruments.  I am also interested in .....

Name.....

Address.....

City..... State.....

## Radio Control of Model Aircraft

(Continued from page 18)

would produce that effect, "straight" being then required to centralize the rudder. The scheme is practical enough but there is the possibility that the pilot would become confused in somewhat the same fashion as he invariably does when using a straight key. It is all simple enough when the machine is flying fairly close and when the rudder movements can be seen. It is a different matter, though, when the ship is a quarter of a mile away and making an up-wind turn. In such a case the response to the rudder movement may be relatively slow and there is always the feeling that the mechanism has failed.

### BUG ELIMINATION

After getting what appeared to be perfect operation of this equipment in the workshop, we proceeded with the installation in the plane. The receiver was built in a rectangular aluminium frame and lent itself readily to "shock-proof" mounting—a heavy rubber band being used from each corner of the frame to some members in the fuselage. Then began a series of preliminary experiments, hand-launching the machine for a glide of a few hundred yards. Within an hour we had decided that we should have made the equipment ten times simpler. We began to appreciate the difficulties that some of the fellows must have bumped into with complex selector switch multi-control systems. The first problem was that in landing one or more of the tubes would usually be bumped out of existence. Then, a couple of severe crackups (the plane hitting a tree) told us the story. In both cases the receiver was substantially demolished and in addition the batteries were pushed through the front of the fuselage and the control equipment wrecked. It appeared that our fancy shock-proof mounting permitted the receiver to plunge forward as the plane hit, pushing the battery supply out the front then recoiling to wreck the remaining apparatus. Promptly, the shock mounting was dispensed with and the receiver built on a small piece of plywood screwed to the bottom of the fuselage. From that time on the machine has suffered equally severe crashes without a tube being broken and usually without the receiver even being knocked out of tune. But the problem of microphonic tubes then reared its head. The shock of the escapement releasing proved sufficient, with most 30-Type tubes, to generate an additional pulse of plate current, so messing up the whole works. This difficulty has been cured simply by selecting tubes which have the least microphonic effect. Doubtless, some almost rigid shock mounting for the detector tubes would provide a complete solution. But we are still a little afraid of shock mounting.

An almost infinite number of problems arise in the design of the plane and in its handling but these are beyond the scope of this story. We will admit, though, that the business of learning to fly on the ground, even with nothing other than a



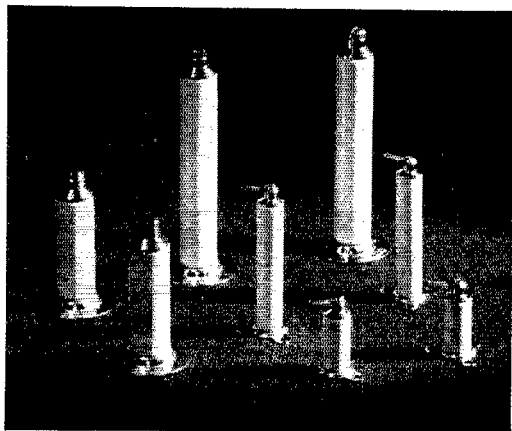
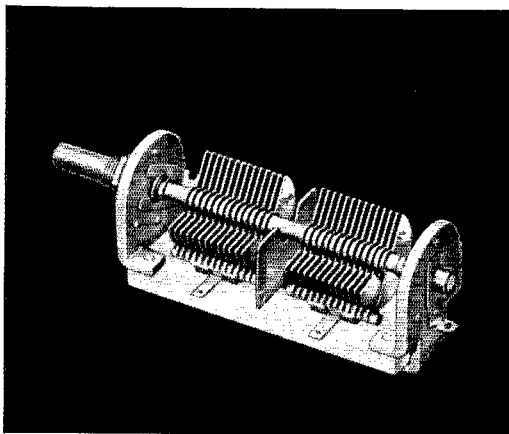
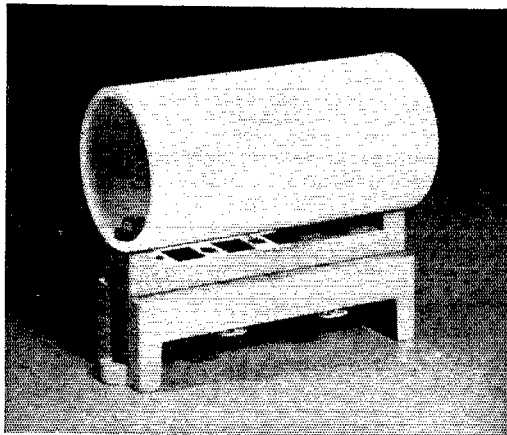
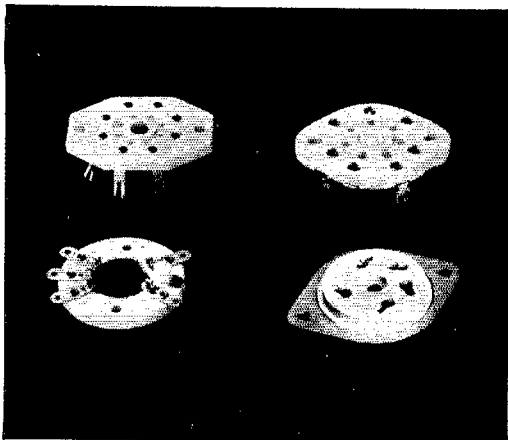

Photos courtesy of Hammarlund Manufacturing Company, Inc., and National Company, Inc.

## HIGH IN—

1. Mechanical Strength
2. Dimensional Precision
3. Surface Resistance

## LOW IN—

1. Electrical Losses
2. Moisture Absorption
3. Thermal Coefficient of Expansion

These are the qualities essential in a good ceramic insulator—not one or two, but all of them. Isolantite\*, possessing all the essential qualities, in addition to many other desirable characteristics, is the choice of the foremost manufacturers of radio transmitting and receiving equipment supplied to commercial radio systems and to the United States Government for military and naval use.

\*Registered Trade-name for the products of Isolantite Inc.

Isolantite ceramic insulators are also available to the amateur. To be sure of getting genuine Isolantite, patronize reliable dealers and ask for the products of leading component parts manufacturers.

# ISOLANTITE INC.

## CERAMIC INSULATORS

Factory: Belleville, New Jersey • Sales Office: 233 Broadway, New York, N. Y.

Say You Saw It in QST — It Identifies You and Helps QST

# Good News...

Cardwell announces General Electric Mycalex as standard insulation on all "T", "X" and Midway condensers. Another step ahead to bring to the host of Cardwell users an H.F. insulation of recognized electrical attributes.

## ● XG-110-KD

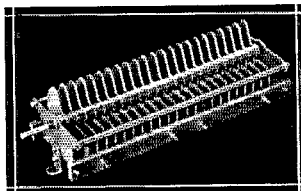

110-110 mfd., .171" air-gap, 6000 V rating, for P.P. tanks.

Typical of the new "X" frame units now supplied with G.E. Mycalex and furnished with mounting brackets for chassis mounting.

Amateurs' Price  
Net \$10.80

## ● MT-150-GS

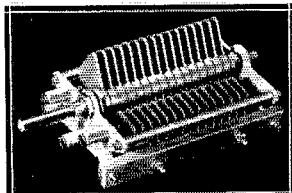

Midway Featherweight 16-150 mfd., .070" gap, 3000 V peak flashover, G.E. Mycalex insulation and aluminum mounting fit for chassis mounting, now standard equipment.

Amateurs' Price  
Net \$3.60

## ● ES-4-SDI

Dual trim air midjet H.F. ganged neutralizer. Two 1.5-4 mfd. 4500 V. sections, completely insulated from each other.

Amateurs' Price  
Net \$2.46

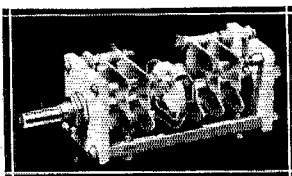

## ● ET-30-AD

Dual trim air, 4-30 mfd. for section .070" gap, 3000 V. for U.H.F. P.P. transmitters.

Amateurs' Price  
Net \$2.96

Also available with same insulated coupling as ES-4-SDI, as ganged neutralizer for P.P. 210's.

Amateurs' Price  
Net \$2.46

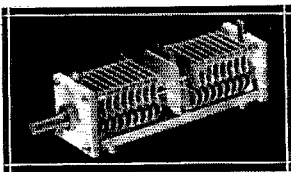

Ask your dealer for new handy bulletin listing hundreds of variable condensers and accessories for all types of transmitters and receivers, and our new catalog No. 40 free for the asking.

Watch Cardwell ads for new and interesting items you have long needed

**THE ALLEN D. CARDWELL  
MANUFACTURING CORPORATION**  
83 PROSPECT STREET, BROOKLYN, NEW YORK

rudder, is actually quite difficult. It is relatively simple to fly the machine in a simple curved path in still air and it is reasonably simple to steer the machine clear of objects providing both they and the machine are within a hundred yards or so. Trying to land the plane on a tree-studded field a quarter of a mile distant is, however, something



LAUNCHING THE SAILPLANE FOR A GLIDE TO THE VALLEY

Normally the ship is winch-towed to a hundred feet or so before being released. In this particular instance we have a hand-launched kick-off. Hull, in the foreground, has run with the ship as fast as he could lick, then launched it with an almighty shove. At the moment he is busy putting on the brakes.

that demands a very special order of skill and, we know, simply cannot be done without a great deal of practice. But it all adds up to a most extraordinary field for experiment and one for which we can see a grand future.

### FUTURE DEVELOPMENT

This crude one-control may seem rather primitive to the fellow who has no difficulty in getting a five-stage transmitter to bend to his will. And it may not fulfill the requirements of the model plane experimenter who insists on a full set of controls. It is, though, an excellent first installation for even the most advanced plane builders. Getting completely reliable and precise operation of nothing more than a rudder is a job full of problems. Acquiring the necessary judgment to use it effectively on even a gas plane (let alone a sailplane) is still tougher.

Before long we will certainly duplicate the rig for elevator control or fix some sort of audio filter to allow the use of a single channel. Possibly, others have already done the job successfully. Naturally, we are eager to swap ideas with other workers in this field. Somehow or other we hams have to lick the thing.

ARMY AMATEUR RADIO STATION

W2SC



WLN

GOVERNORS ISLAND, N. Y.

TO SEND REPLY, OR FOR INFORMATION PHONE WHITEHALL 4-8010 EXT. 578

144VE1IN SJ 31

BOWDOIN KENT ISLAND EXPEDITION AUG 6 37

AMPEREX ELECTRONIC PRODUCTS 79 WASHN ST  
BROOKLYN NY

WE ARE USING FIVE AMPEREX TUBES WITH GREAT SUCCESS ON  
OUR LATEST EXPEDITION STOP THE ZB ONE TWENTY TUBES HAVE  
BEEN GIVING US PERFORMANCE USUALLY EXPECTED IN MUCH  
LARGER TYPES

VE1IN PER THOS GROSS

1/32P

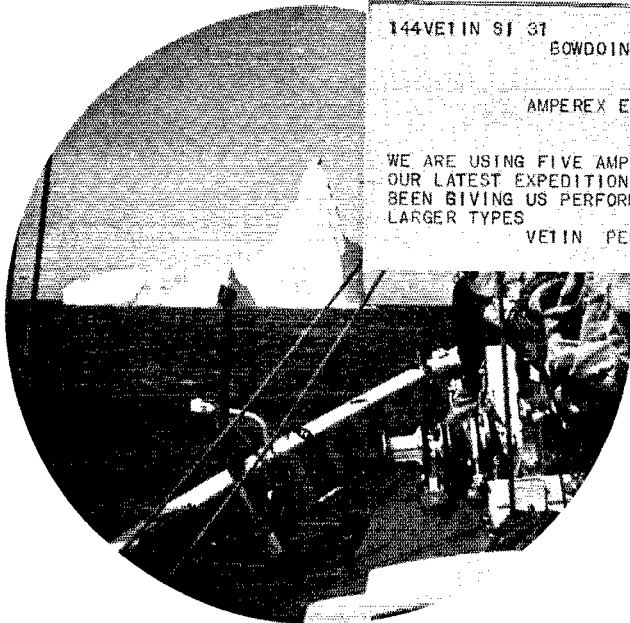

THIS year, again, the Bowdoin-Kent Island Expedition chose AMPEREX tubes. And again we received their relayed message (re-produced above).

## "... using five Amperex tubes with great success"

### Amperex ZB-120 Class "B" Zero Bias Amplifier General Characteristics

Amplification Factor . . .	90
Grid to Plate Transconductance at 100 ma . . .	5,000
Filament Voltage . . . . .	10 volts
Filament Current . . . . .	2 amps
Maximum Allowable Plate Dissipation . . . .	75 watts

**\$10.00**

Thank you, Mr. Gross, and thank you, members of the expedition . . . we are always pleased to hear such fb reports that confirm the wisdom of an Amperex policy that is based not upon "how many tubes can we sell" but "how well will they work." Amperex tubes must give superior performance . . . must last longer . . . and must operate economically.

**AMPEREX ELECTRONIC PRODUCTS, INC.**

79 WASHINGTON STREET

BROOKLYN, NEW YORK

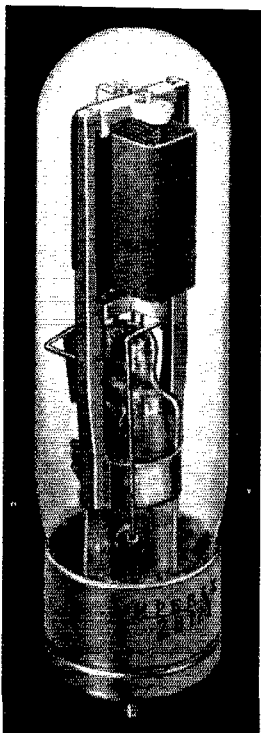



**LEADS THE FIELD**

World Wide Service to Amateurs

**Taylor Tubes**

We carry the complete line of Taylor Custom Built Tubes -- from the first to the last -- Including the NEW T-125 low C -- Low impedance 400 watt... **\$13.50**  
Get the Taylor Manual -- yours for the asking.

45 Vesey Street  
New York City

Tel. COrtlandt 7-2612

Cable Address: "RADLEEDS"

**Raytheon Tubes**

Our stock is complete  
"Beam Tubes." Highest efficiency, lowest driver requirements.  
RK-47.....\$17.50  
RK-48.....27.50  
All other types carried in stock.

**STEEL MASONITE RACK ALUMINUM PANELS**

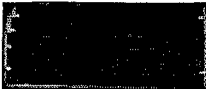

furnished in standard 19" length. Steel and aluminum, black shrivel finished 1/4" thick, W.E. or amateur slotting. Masonite crystalline black or silver gray finish, 1/4" thick W.E. slotting.

Steel	Price	Width	Aluminum	Price	Masonite
PS-1.....	\$.52	1 1/4"	PA-1.....	\$.74	.....\$3.36
PS-2.....	.57	3 1/4"	PA-2.....	1.03	......43
PS-3.....	.63	5 1/4"	PA-3.....	1.30	......54
PS-4.....	.71	7"	PA-4.....	1.55	......69
PS-5.....	.95	8 3/4"	PA-5.....	1.90	......87
PS-6.....	1.15	10 1/4"	PA-6.....	2.45	.....1.05
PS-7.....	1.30	12 1/4"	PA-7.....	2.90	.....1.23
PS-8.....	1.50	14"	PA-8.....	3.35	
PS-9.....	1.70	15 1/2"	PA-9.....	3.70	
PS-10.....	1.90	17 1/2"	PA-10.....	3.95	
PS-11.....	2.05	19"	PA-11.....	4.45	
PS-12.....	2.30	21"	PA-12.....	5.20	

Other sizes -- Price on request. State slotting desired in order.

Westinghouse 2.4 amp circuit breaker; A.C. or D.C.; fully cased, \$1.25  
General Electric D.P.S.T. circuit breaker; 7 amp. Thermal controlled; 2 or 3 wire or 2 separate circuits.....\$1.49  
**LEEDS RELAY** -- S.P.D.T. mounted in Bakelite case; 7 1/2 v. D.C.....\$9c

We carry at all times a complete stock of **Thordarson Transformers**, **Triplett Meters**, **Cornell-Dubiller**, **Aerovox** and **Cardwell Condensers**.

**VICTRON G**

The magic insulator of Radio. See our advertisement in August issue.

**LEEDS TRANSFORMERS**

-- high voltage, completely shielded. See July QST for details and prices.

**LEEDS CHOKES**

Described in July QST or write us for information.

Navy Type  
Telegraph  
Key



List \$3.60. Navy knob -- 1/4" Tungsten contacts. While they last..... **\$1.15**  
With regular knob.....95c



**LEEDS LD-5 Crystals**, unconditionally guaranteed. Cut to your specified frequency at no extra charge. In the 40-80 and 160 meter bands; only...\$3.50  
**LEEDS AL metal crystal holder**, fits any standard 5 prong socket.....89c

**NEW General Radio**

3 prong socket. A sturdy, bakelite socket, with heavy contacts, each of which is separated by a bakelite wall. Each 40c, or 10 for...\$2.75

**General Radio**

Variacs and parts in stock

677-U coil forms, 21 turns, 2 1/2" dia. resonant on 3.5 mc. 100 mfd. cap.....50c  
677-V -- 30 turns 4" dia. resonant 1.7 mc. 100 mfd. cap.....75c

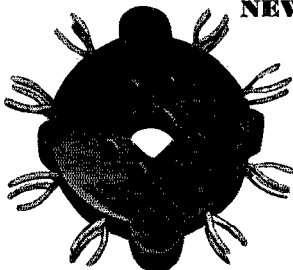

With European Amateurs on the Bucharest C.C.I.R. Trip

(Continued from page 16)

luncheon at which Mme. Auger was our hostess, we began an extended discussion of I.A.R.U. matters, particularly with regard to more effective distribution of information among the I.A.R.U. societies and the achievement of the proposed expansion of the 7-Mc. band in the Cairo proposals of the French government which was brought about by the splendid work of the R.E.F. Later that day we made a flying trip to F8EF's summer home outside of Paris, at Pomponne, where his station is located. Here we attempted to keep a schedule with W1EH but were thwarted by a local thunderstorm which made 14-Mc. reception impossible.

After a rapid drive back to Paris we were received at the home of Mr. Barba, president of the R.E.F., where mutual formal greetings were exchanged and where we each recorded a short statement for subsequent distribution to the society's members throughout France. In the evening of the same day the R.E.F. gave an official dinner at which Mr. Barba, F8LA, presided and at which representatives of the Belgian national society, Lieutenant Guy de Borchgrave, ON4ID, president of the R.B., and Mr. Marcel Dupuis, ON4EY, were also guests. Thus our Paris visit gave us the opportunity to meet representatives of both the R.E.F. and R.B. to discuss Union matters. ON4ID, who is an officer in the Belgian army, had made the air trip to Paris that day for the particular purpose of seeing us and flew back to Brussels that same night.

Discussions with the French amateur officials revealed more clearly the advances recently made by the R.E.F. in furthering amateur recognition by the French government and emphasized the evidence of this improvement in obtaining the 7-Mc. band proposals by the government administration. President Borchgrave of the R.B. explained to us the progress which had been made in Belgian amateur affairs, especially the improved unification of the two amateur groups which had just been accomplished. We, in turn, reported on the international picture as revealed in the conference at Bucharest and discussed with them the various aspects of possible future development.

The following day, Saturday, was devoted to a rapid inspection of the Paris exposition and the interesting 120-kw. regional broadcast transmitter at Villebon. This transmitter employs the latest version of the "out-phasing" system of modulation, developed by H. Chireix, in which high-efficiency linear amplification is obtained in the final stage. Dinner that evening with Messrs. Auger, Aubry, Tiffenau and Mme. Aubry ended a busy day.

Our visit with the French hams revealed a new era in amateur radio in France, with rapid technical progress, improved government rela-

<sup>2</sup>H. Chireix, "High-Power Outphasing Modulation," Proc. I.R.E., Nov., 1935.

# A "QSL"

TO "HAMS" WHO SOMEDAY WILL WORK HAND-IN-HAND  
WITH BENDIX IN THE ADVANCEMENT OF RADIO

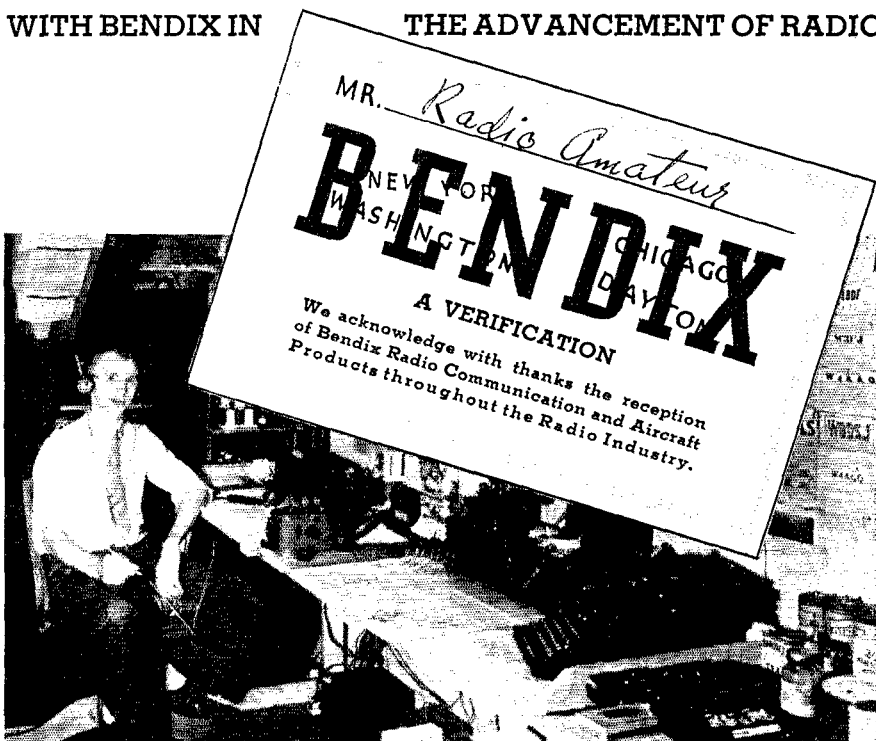

**S**OMEDAY the name BENDIX will play a mighty important part in your Radio career. Whether your goal lies in the laboratory, maintenance, or operation, you will find the way made easier with the accurate, dependable aid of Bendix Radio products. The technical and manufacturing resources of the Bendix Radio Corporation are constantly developing new ways . . . better ways to make radio circuits and communications more accurate . . . dependable . . . and convenient.

## BENDIX

RADIO CORPORATION

NEW YORK • WASHINGTON • CHICAGO • DAYTON

# MORE and MORE

## IN IMPORTANT PLACES



Since the beginning of this year alone, UNITED Type 966 rectifiers have been purchased by thousands of new users. The obviously better design of this tube is rapidly attracting the preference of well informed amateurs the world over.

We believe UNITED is the fastest selling tube of this type on the market right now.

The main reasons are:

1. **QUICK STARTING:** A few seconds *initial* pre-heating vs. full 15 minutes stipulated for other makes. Also, specially designed filament comes up to full emitting temperature instantly, resulting in negligible time delay in routine operation.
2. **CONTROLLED MERCURY:** Measured pellet *exploded after exhaust* prevents excess mercury amalgams with elements and getter, hence longer filament life.

*Interchangeable with 866 tubes of all makes*

**UNITED ELECTRONICS CO.**  
42 SPRING STREET  
NEWARK NEW JERSEY

tionship and an advanced position in the international amateur picture as highlights. And through it all we found that traditional amateur spirit always in evidence.

LONDON AND THE R.S.G.B.

A relatively short train-ferry trip from Paris to London was a welcome relief after the longer and more uncomfortable journeys across the continent and back, leaving us refreshed and eager for our first meeting with the G's shortly after our arrival Monday morning. Before noon we were at the R.S.G.B. headquarters in the office of Jack Clarricoats, G6CL, secretary of the society and editor of the *T & R Bulletin*. After luncheon with Jack Clarricoats, Arthur Watts, and Art Milne, we participated in an all-afternoon session with the R.S.G.B. Council in which the proceedings of the Bucharest conference were reviewed, the results reported and relations between the R.S.G.B. and I.A.R.U. with reference to Cairo were discussed.

That same evening we were tendered a complimentary dinner by the R.S.G.B., over which President E. D. Ostermeyer, G5AR, presided, with a number of other well-known figures in British amateur affairs in attendance. These included G6CL, G6UN, G6NF, G2TI, G2MI, G6OT, G6UT, G5QF, G6WN, G2UJ, G2WV, G2NH and G6WY. With everyone speaking English, participation in the discussion was more general than had been possible in our previous meetings where other languages prevailed, and the whole gamut of amateur topics, from serious to comic, made an interesting and happy evening fly quickly. We told them of the pleasant times we had had with our amateur friends in the countries we had visited previously and pointed out that the friendly amateur spirit which we found to prevail in England was exactly the same as we had found it with the hams in Germany, Roumania and France.

The following day, June 15th, was given up to visiting representative amateur stations, including G2MI, G6WY, G6NF, and G2IG. Although English-made equipment predominates, we were surprised to find a goodly percentage of American-made apparatus, including transmitting tubes and at least one American receiver. Even in England, as we had also found in the other countries, the supply of commercially available amateur parts is restricted in variety, as compared to what we have over here, principally because English manufacturers do not seem to be interested in meeting the demand which unquestionably exists. This was emphasized to me by Mr. Hugh Pocock, editor of *Wireless World*, with whom we had an interesting visit in his offices before we left London. He explained that the attitude of British manufacturers toward supplying parts especially designed for amateur and experimental use made the development of circuits a pretty difficult problem. Possibly because of the nominally experimenter status of British amateurs, as established by government regulations, the equipment is largely of the open-construction experimental type, although there is a tendency

# Delco-Remy

## HIGH-OUTPUT GENERATORS FOR PLEASURE CARS

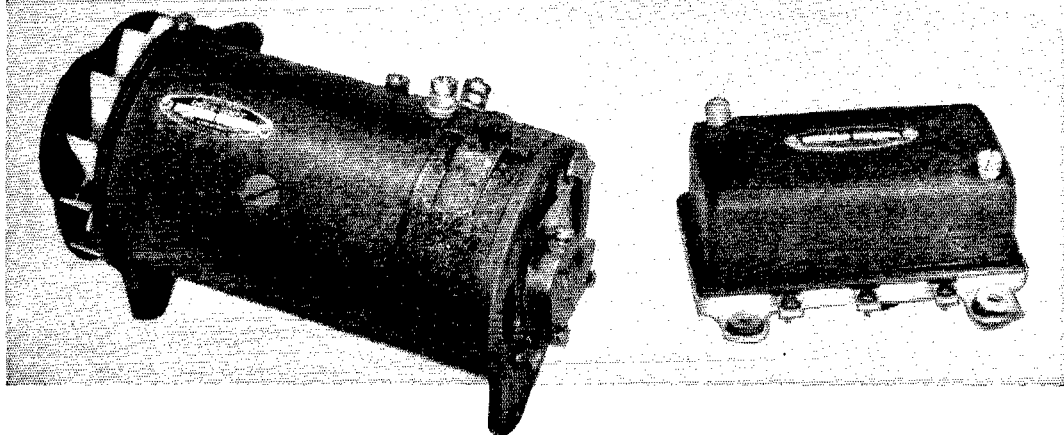

Delco-Remy Model 961-N high-output generators, specially designed to furnish extra current for added electrical accessories on pleasure cars, also assure a fully charged battery for quick winter starting. As much as 26 to 28 amperes can be delivered by this low-cost generator whenever it is required—even at high driving speeds. This high output also meets the demand for the extra current requirements of amateur radio transmission.

The Model 961-N generator is complete with current and voltage regulator, wiring, and all necessary attaching parts. The Delco-Remy regulator controls the voltage *at the battery*, preventing battery overcharging and excessive voltage within the electrical system—and *it does not cause radio interference*.

Delco-Remy Model 961-N generators may be installed on most cars. Any Branch or Electrical Service Station of United Motors Service can supply them.

# Delco-Remy

ANDERSON, INDIANA



Delco-Remy products are sold and serviced by United Motors Service Stations everywhere . . . wherever you see this sign.

**World's Largest Manufacturer of Automotive Electrical Equipment**

Say You Saw It in QST — It Identifies You and Helps QST

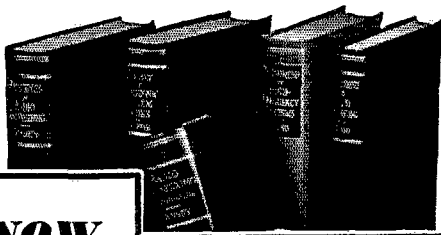

## **NOW** **this high-powered radio engineering library**

**sent to you for 10 days' trial —  
at a special price and terms**

These books cover circuit phenomena, tube theory, networks, measurements, and other subjects — give specialized treatment of all fields of practical design and application. They are books of recognized position in the literature — books you will refer to and be referred to often. If you are a researcher or experimenter — if your interest in radio is deep-set and based on a real desire to go further in this field — you want these books for the help they give in hundreds of problems throughout the whole field of radio engineering.

### **RADIO ENGINEERING LIBRARY**

— especially selected by radio specialists of McGraw-Hill publications

— to give most complete, dependable coverage of facts needed by all whose fields are grounded on radio fundamentals

For home-study and reference. Contains a revised selection of books culled from latest McGraw-Hill publications in the radio field.

**5 volumes, 3064 pp., 2000 illustrations**

1. Glasgow's PRINCIPLES OF RADIO ENGINEERING
2. Terman's MEASUREMENTS IN RADIO ENGINEERING
3. Chaffee's THEORY OF THERMIONIC VACUUM TUBES
4. Hund's PHENOMENA IN HIGH-FREQUENCY SYSTEMS
5. Henney's RADIO ENGINEERING HANDBOOK

**Special Low Price and Easy Terms**

Bought singly, the five volumes comprising this library would cost you \$25.00. Under this offer you save \$1.50 and, in addition, have the privilege of paying in easy installments beginning with \$2.50, 10 days after receipt of the books, and \$3.00 monthly thereafter. Take advantage of these convenient terms to add them to your library now.

#### **SEND THIS ON-APPROVAL COUPON**

**McGraw-Hill Book Co., Inc.  
330 W. 42nd St., New York, N. Y.**

Send me Radio Engineering Library, 5 vols., for 10 days' examination on approval. In 10 days I will send \$2.50, plus few cents postage, and \$3.00 monthly till \$23.50 is paid, or return books postpaid. (We pay postage on orders accompanied by remittance of first installment.)

Name.....

Address.....

City and State.....

Position.....

Company..... *QST-10-37*

(Books sent on approval in U. S. and Canada only.)

in present designs toward the rack-and-panel construction of more "commercial" appearance.

The evening after our round of visiting stations was spent at the home of Mr. Arthur Watts, G6UN, where we enjoyed a real English dinner with our host and Mrs. Watts, and later established contact with W1EH. This QSO gave Arthur's new and practically unused transmitter a real workout with four or five different operators taking turns at shooting signals at "KB" in West Hartford. The next evening we had another QSO from Art Milne's station, G2MI, which, unfortunately, we had to cut short slightly before midnight in order to catch the last train back to London.

The remaining days of our visit, awaiting the sailing of our ship, were spent in studying the latest technical developments in British transmitting and receiving equipment, including television. There has been so much said recently both in the newspapers and the popular radio magazines reporting on the present status of British television that it should be hardly necessary to go into great detail here. The present system is based on the American technique of electronic camera pickup for transmission and cathode-ray tube reproduction in the receiver with a 405-line picture. Considerable progress has been made in the televising of different types of programs, including out-door events, largely because the service has been running daily on regular schedules and there has been, accordingly, greater opportunity for actual field testing to supplement laboratory investigation. Needless to say, we found the picture reproduction excellent and the programs really entertaining. We also became acquainted with the details of incidental technical developments which are now being put to good use in the evolution of the amateur television series which *QST* is inaugurating.

Despite these few days of diversion from amateur contact, we did not leave England without returning to amateur affairs. Before sailing we joined Arthur Watts and Jack Clarricoats in a final "clean-up" session to discuss further plans for the immediate future with particular reference to Cairo; and the morning we left we found that we still were not forgotten. Arthur and Jack were at the boat train to see us off and as a parting memento we were presented with two real English roses which Mrs. Watts had picked from her garden for us that morning. As the *President Roosevelt* pulled out of the harbor at Southampton, we realized that here, too, we had found the truest evidence of real amateur spirit.

\* \* \* \* \*

There is no doubt that these visits with European amateur groups, made possible by the trip to the C.C.I.R., have served to further international solidarity and to promote a better understanding than could be achieved by an infinite amount of correspondence and communication over the air. The International Amateur Radio Union plays a far greater part in our individual existence than might be indicated by the several pages devoted to it each month in *QST*. Amateur



Dial 2-5562.

OWEN O. TRESSLER

TRESSLER RADIO SERVICE  
234 Oakwood Avenue  
ELMIRA HEIGHTS, N.Y.

Centralab  
900 E. Keefe Ave.  
Milwaukee, Wis.

**CENTRALAB VOLUME CONTROLS  
cannot be equalled!**

Centralab volume controls I  
have used Centralab volume controls for  
years and find that they cannot be equalled  
in quiet in operation, but they FIT the sets  
they are built for.

Very sincerely,  
*Owen Tressler*

Owen O. Tressler

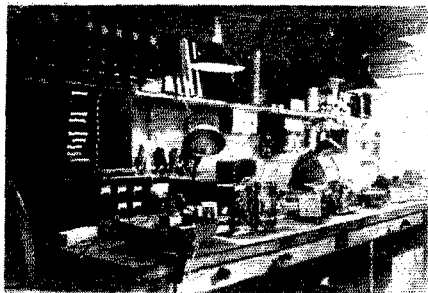

A corner of Mr. Tressler's service shop, located in Elmira Heights, a suburb of Elmira, N. Y. The largest service shop in Elmira — employs three service men. Mr. Tressler has a service background of thirteen years.

### Says Mr. Owen O. Tressler . . .

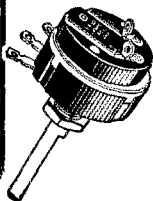

"I have used Centralab volume controls for the past three years, and FIND THEY CANNOT BE EQUALLED. Not only are they quiet in operation, but they FIT the sets they are built for."

Mr. Tressler is but one of the many radio men throughout the land who prefer CENTRALAB controls for "satisfactory" replacements. Manufacturers, experimenters and set builders have in growing numbers changed to CENTRALAB for better performance. Specify "CENTRALAB."

**DIVISION OF GLOBE UNION, INC.**  
MILWAUKEE, WISCONSIN

BRITISH CENTRALAB, LTD.  
Canterbury Rd., Kilburn  
London, N.W. 6, England

FRENCH CENTRALAB CO.  
118 Avenue Ledru-Rollin  
Paris XI, France

# Centralab

# AVIATION RADIO

## JOBS for HAMS



**W9DFY** — George Osborn,  
Emporia, Kans.  
Now employed with a  
major U. S. airline.

Rapid expansion on the part of the nation's airlines has made it imperative that they employ more and more radio operators who are well-versed in Airline radio operating procedure. The supply of qualified men is virtually exhausted.

With the cooperation of experienced, actively employed Airline radio operators and communications personnel, we have established and developed our highly specialized, thoroughly practical course in Airline radio operating.

**RESULT: Many more calls for our men than we are now able to supply!**

As an amateur you have an invaluable advantage in favor of early employment. But we have found from experience that the average "ham" is inclined to be skeptical of such optimism. **WE WELCOME THE STRICTEST INVESTIGATION.** This "checking" has rewarded several "hams" and it can be to *your* advantage, too.

Some of the more active and widely known "ham" operators who have joined their radio experience with Midland training include:

**W9LHQ  
W9YCT  
W9HON  
W9IQI  
W9DFY**

These hams, together with many others, are **ALREADY EMPLOYED** in fine, highly respected, responsible positions with leading U. S. airlines.

If *you* are between 18 and 30, have a high school education, are free of uncorrected physical defects, and really like radio operating, it will be to your advantage to get in touch with Norm G. Souther immediately. Write or wire

**NORM G. SOUTHER**  
**MIDLAND TELEVISION, INC.**  
(Midland Broadcasting Company Affiliate)  
29th Floor Power and Light Building  
**KANSAS CITY, MISSOURI**



**W9IQI**  
Rolfe Terrill,  
Robinson, Kans.  
Now employed  
with a major  
U. S. airline.

radio is not only world-wide in that it provides each of us with the opportunity to exchange signal reports with a fellow amateur in some foreign place when the urge for DX takes hold, but it also is truly world-wide in our day-to-day local and national activities. For if our ruggedly individual selves were not knitted together in strong national societies, and if our separately autonomous national societies were not united in a world-wide international union, then there would be little likelihood of amateur radio communication for any of us as individual operators. It takes only two amateurs to make a contact over the air. But it takes the continuing united effort of thousands of us in all parts of the world to make such contacts possible.

### A Semi-Universal Exciter

(Continued from page 19)

mounted horizontally between two insulating lugs, and occupies a position midway between  $C_1$  and  $C_2$ . The plate blocking condenser,  $C_5$ , is mounted on its terminal wires between the hot end of the choke and the stator plates of  $C_1$ .

In the doubler circuit, each plate choke goes directly to a meter jack. The plate blocking condensers,  $C_6$  and  $C_7$ , mount between the plate terminals on the tube socket and a pair of lugs on an isolantite terminal strip (insulator from a variable condenser) which is mounted on a small metal pillar so that it is about an inch away from the chassis. From these points, connections go to the tank circuits, and also through the grid coupling condensers,  $C_9$  and  $C_{10}$ , to the switch. The left-hand lug on the strip is a junction point for the first grid coupling condenser,  $C_8$ , and the lead to the switch.

The grid chokes for the 6N7G are mounted vertically at the right side of the switch, the lower terminals going to an insulated double lug. The grid leaks,  $R_2$  and  $R_3$ , go from the strip to ground.

The socket for the 807 is the last on the right. Just below it is the grid choke. The screen by-pass and heater by-pass are clearly visible in the photograph. The 807 grid leak,  $R_4$ , and the oscillator screen voltage divider,  $R_6$  and  $R_7$ , are mounted on a lug strip parallel with the rear of the chassis. The large resistor is  $R_5$ .

The oscillator feedback condenser,  $R_{15}$ , is made by cutting two  $\frac{3}{8}$ -inch square plates, with mounting tabs on one side, from thin copper. The tabs are soldered to the grid and plate terminals on the tube socket and the plates arranged to face each other with about a quarter-inch separation. The adjustment is not critical; use the greatest spacing which will permit the oscillator to "start" regularly. Greater capacity increases the r.f. voltage across the crystal without adding anything to the circuit performance.

All grounds are made directly to the chassis.

Power leads are brought to a terminal strip on the edge of the chassis—at the left-hand side in the bottom view. The output link is connected to a two-terminal strip on the rear edge.

**THE EIMAC  
TOOTH TUBE**

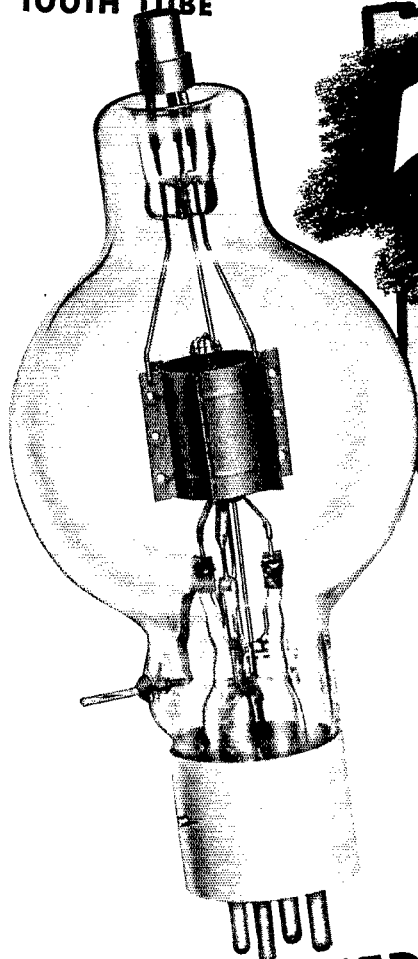

**IT'S A  
SECRET!**

Some years ago a brilliant scientist achieved success in producing a perfect synthetic imitation of a hen's egg. The texture, color and chemical components of the white, yolk and shell were perfect. But the egg wouldn't hatch. The chemist could never know the hidden secret—the way to make an egg fertile, to give it that magic spark of life. Eimac Tubes (like the egg) cannot be duplicated.

**OFTEN COPIED... never duplicated**

No less than six manufacturers have tried in vain to duplicate their performance. They have copied the physical appearance of Eimac Tubes. Some are using tantalum, too, but not one can duplicate the Eimac application of this superior metal. The hidden values—the invisible features of Eimac Tubes are what give them the power to stand up under intense heat, carry an unusually heavy extra load and allow you to "sock" the ether waves with terrific jolts.

The success of Eimac is notable in the industry. Introduced only three years ago, thousands of "Hams" in every part of the United States and abroad, are enthusiastic users of Eimac Tubes. If a nearby distributor cannot supply you, write us for information.

**PLAY SAFE... INSIST ON**



**EITEL & McCULLOUGH, Inc. • San Bruno, California**

Say You Saw It in QST — It Identifies You and Helps QST

# HERE'S WHY

# UTAH

## TRANSFORMERS

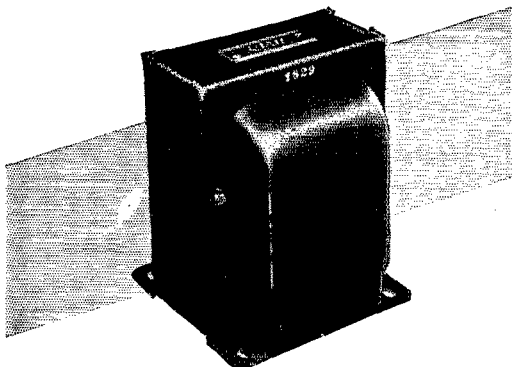

## IMPROVE TRANSMITTER PERFORMANCE

- ✓ Lower eddy current loss, with less consequent heating—two definite results of UTAH'S unique design and construction.
- ✓ Greater magnetic field efficiency—due to special transformer core materials, sized and shaped for best results. This exclusive design was evolved after 15 years' experience.
- ✓ Unusually high safety factors, in both insulation and design, for better performance and longer life.
- ✓ Positively sealed against humidity.

Send your specifications to Dept. Q-10. Prove to yourself that UTAH transformers work better, last longer, but cost no more!

**UTAH RADIO PRODUCTS CO.**

CHICAGO, U. S. A.

TORONTO ONTARIO, CANADA BUENOS AIRES (UCOA RADIO PRODUCTS CO.)

**"16 YEARS OF LEADERSHIP"**

The stage switch is a standard item having three gangs, each with six contacts (this seems to be the minimum number of contacts available on gang switches without going into special designs). Since only three contacts per gang were needed, the alternate contacts were removed, thus giving greater spacing and reducing capacity effects. The gang nearest the panel connects to the first 6N7G grid; that nearest the back of the set connects to the 807 grid. Although longer-than-normal leads are unavoidable in a switching circuit of this kind, this arrangement gives the highest frequencies the benefit of the shortest leads. It has worked out very well in practice.

### TUNING AND ADJUSTMENT

Operation is quite straightforward. Coils for consecutively higher-frequency bands are plugged in at  $L_1$ ,  $L_2$  and  $L_3$ ; only five are necessary for operation with any crystals from 1.75 to 7 Mc. and for output from 1.75 to 28 Mc. For example, with 3.5-Mc. crystals, the 3.5-, 7- and 14-Mc. coils would be plugged in at  $L_1$ ,  $L_2$  and  $L_3$  respectively. For 1.75-Mc. crystals, the 1.75-, 3.5- and 7-Mc. coils would be used, and so on.

To tune up, first open the plate circuit of the 807 by inserting an open-circuited plug in the plate jack,  $J_4$ , or taking out the plate coil,  $L_4$ , and apply bias and plate voltage. With the switch in the lower position in Fig. 1 (all tubes in use) and the meter plug in  $J_1$ , turn  $C_1$  until the familiar oscillation dip occurs. The plate current should drop from about 40 ma. to approximately 20 ma. Move the meter plug to  $J_2$  and adjust  $C_2$  to resonance (minimum plate current), then move the plug to  $J_3$  and repeat. In both cases the off-resonance plate current should be around 50 or 60 ma. and in-resonance about 20 to 25 ma. The last adjustment should be made quickly and the plate power then shut off, to avoid overheating the 807 screen. With the appropriate coil at  $L_4$ , the meter plug may then be inserted in  $J_4$ , plate voltage applied and  $C_4$  adjusted to resonance. Unloaded minimum plate current on the 807 will range between 10 and 15 milliamperes, depending upon the frequency and the coil in use. Remember that each coil covers two bands, so that if the 807 is excited on the frequency to which the plate circuit is resonant with near-maximum capacity, the condenser can simply be swung to the other end of the scale for doubling. Minimum plate currents when doubling of course run higher than when amplifying straight through, but should not exceed 25 or 30 ma. even on 28 Mc., where the tank losses are highest. In every case the tube can be loaded to about 100 milliamperes.

Fixed bias is used with the 807 for two reasons. First, the plate current is held down in case excitation is lost, and second, fixed bias stabilizes the tube. Despite shielding, the high power sensitivity of the tube causes it to go into oscillation very readily. Rather than go to elaborate shielding, it seemed to us simpler to use a little fixed bias. Bias of the order of 50 volts, which brings the plate current without excitation down to about 40 or 50 ma., is sufficient for stabilization; the 100 volts indicated on the diagram is almost,



# TOUGH!

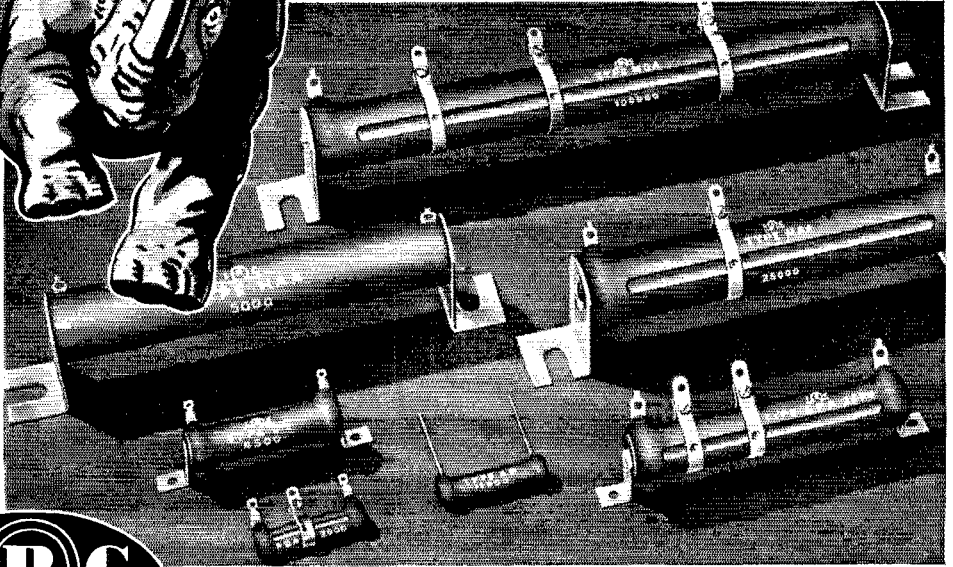

## TRANSMITTING POWER WIRE WOUNDS

*They'll Stand the Overloads!*

- **Moisture Proof**
- **Greater Load Capacity — Lower Surface Temperature**
- **Greater Mechanical Strength**
- **Longer Life**
- **Non-porous Ceramic Core**

HERE are Heavy Duty wire wounds that are really built to take it! Tough as a rhino — dependable as the North Star — durable as only years of research by the world's leading resistance specialists can make them!

Not only does the unique IRC cement coating of these resistors assure exceptionally rapid heat dissipation, but it is the finest material known for protection against moisture — even salt water immersion. The fact that it is applied to the resistors at low temperatures avoids any chance of damaging resistance windings as sometimes happens with other types of coatings put on under extreme temperatures.

Made in a complete line of fixed and adjustable types. Write for IRC Resistor Catalog 41.

## INTERNATIONAL RESISTANCE COMPANY

401 NORTH BROAD STREET, PHILADELPHIA, PA.

Factories or Licensees in Canada, England, France, Germany, Italy, Denmark and Australia

MAKERS OF RESISTANCE UNITS OF MORE TYPES, IN MORE SHAPES, FOR MORE APPLICATIONS THAN ANY OTHER MANUFACTURER IN THE WORLD

Use  
**YAXLEY**  
APPROVED RADIO  
PRECISION PRODUCTS

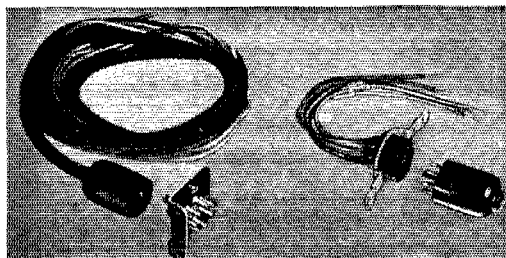

## YAXLEY Cable Connectors

Don't spend minutes of valuable time tracing wiring to find "which wire goes to what" when connecting your receiver to its power supply.

Don't take chances on burning out valuable equipment by making incorrect connections between the chassis of your rack and panel transmitter or P. A. system. Save time and effort when hooking-up your portable equipment.

Use Yaxley Cable Connectors for the instant connecting or disconnecting of any apparatus. The receptacles and plugs are polarized to prevent incorrect insertion.

Available in both 7-wire and 12-wire types, complete with cable or separately as desired. The prices are reasonable. Ask your distributor to show you Yaxley Cable Connectors—or write for details.

**P. R. MALLORY & CO., Inc.**  
**INDIANAPOLIS INDIANA**

Cable Address—PELMALLO

Use  
**P. R. MALLORY & CO. Inc.**  
**MALLORY**  
APPROVED RADIO  
PRECISION PRODUCTS

but not quite, cut-off. The gridleak,  $R_4$ , is helpful in increasing efficiency when the tube is used as a doubler; when amplifying straight through it is not necessary, although its use causes no appreciable reduction in output. Grid current is of the order of 3 to 5 ma. with both gridleak and fixed bias, so the excitation is considerably more than is needed. The low grid-current requirements make blocked grid keying (of the type used on the suppressor of pentode-type tubes) eminently suitable, and thus facilitates the elimination of key clicks. Alternatively, the key could be inserted in the 6V6G cathode circuit for break-in operation, since the 6N7G plate current drops to a safe value without excitation.

Slight retuning may be necessary when switching from one band to another, since the input capacities of the triodes and 807 differ. Metering is not necessary for this purpose; simply adjust for maximum final output. When changing frequency within a band, retuning will not be necessary unless the two frequencies are fairly widely separated. With variable-frequency crystals such as the Bliley VF-1 unit shown in the photograph, the output is constant over the whole range of crystal variation.

As we mentioned earlier, it is easy to realize 40 watts output on any of the five bands without exceeding the tube ratings. This is not only adequate for exciting much larger amplifiers, but also for putting into an antenna for low-power work. As a complete transmitter, this unit is compact, easy to handle, rapid in band changing, and requires only one plate supply.

### Modernizing the Simple Receiver

(Continued from page 25)

the amplifier from radio frequency currents flowing in the detector circuit. A second r.f. choke, in series with the screen, strengthens oscillation by discouraging attempts of r.f. currents to flow from the screen back into the regeneration

COIL TABLE

Coil	Band (Mc.)	Winding Length (Inches)	No. Turns	Cathode Tap Turns	Wire	Tuning Range (Kc.)
L1	1.7	11 $\frac{3}{16}$	90	15	No. 28 d.s.c.	1160 to 2930
L2	3.5	1 $\frac{1}{2}$	35	8	No. 24 d.c.c.	2900 to 7050
L3	7	1 $\frac{3}{8}$	15	3	No. 24 d.c.c.	7000 to 12,000
L4	14	$\frac{7}{8}$	7	2	No. 24 d.c.c.	10,000 to 15,400

All coils are close-wound on 1-inch diameter forms. Cathode tap turns are counted from the ground end of each coil.

**PROOF . . .**

**THE AMERICAN RADIO RELAY LEAGUE  
RADIOGRAM**

VIA AMATEUR RADIO

<b>CITY OF ORIGIN</b> Schooner Effie M. Morrissey	<b>STATION OF ORIGIN</b> W 10 XDA	<b>NUMBER</b> #66	<b>DATE</b> July 30, 1937	<b>CHECK</b>
<b>To</b> Radio Mfg. Engineers, Inc., Peoria, Ill. (PLACE)				
306 First Avenue, (STREET)				

WORDS FAIL TO EXPRESS HOW WELL THE RME-69 and DB-20 ARE PERFORMING  
UNDER SEVERE CONDITIONS. WE COULD WISH FOR NOTHING BETTER.  
GREETINGS FROM NORTHWEST GREENLAND.

CLIF FOSS,  
RADIO OPERATOR,  
SCHOONER MORRISSEY,  
BARTLETT EXPEDITION.

<b>SENDER'S ADDRESS AND PHONE NUMBER FOR REFERENCE</b>	<b>LOCATED AT</b>	<b>DATE</b>	<b>TIME</b>	<b>OP'R</b>	<b>SENT</b>	<b>TO ST'N</b>	<b>LOCATED AT</b>	<b>DATE</b>	<b>TIME</b>
REC'D FROM ST'N W10XDA	77 deg. N. Lat.	7/30	10:25P	Foss					

PLEASE READ OTHER SIDE - IMPORTANT

PRINTED IN U. S. A.

*Capt. Robert A. Bartlett and Radio Operator Clifton Foss, shown with their RME-69 on the Schooner Effie M. Morrissey of the Bartlett Greenland Expedition of 1937, under the auspices of the Smithsonian Institution and the Chicago Zoological Society.*

Again, the RME-69 Receiver is proving its reliability in difficult situations . . . in remote places where human lives depend upon the maintenance of uninterrupted communications . . . where continuous, trouble-free performance is a vital factor.

*Write for Bulletin 69*

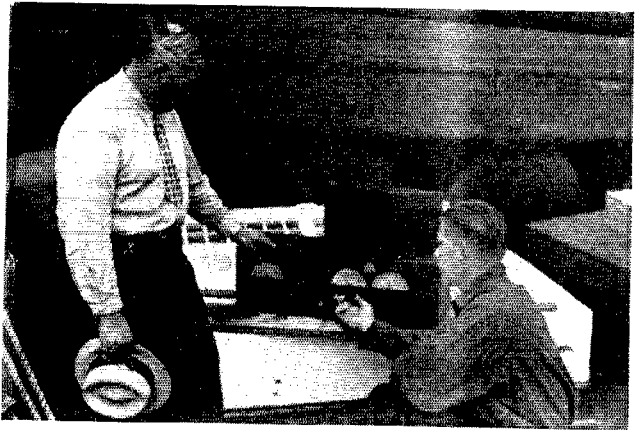

**RADIO MFG. ENGINEERS PEORIA ILLINOIS**

RME - 69

Say You Saw It in QST — It Identifies You and Helps QST

# OHMITE RHEOSTATS

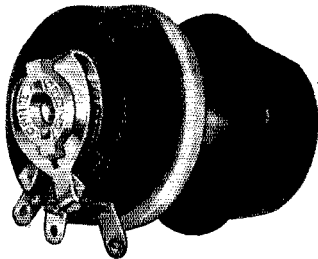

These all-porcelain rheostats provide close, accurate, primary voltage control that prolongs the life of transmitting tubes and keeps them operating at peak efficiency. They are built entirely of porcelain and metal, with no organic material to smoke or char. Model H, J and K are rated at 25, 50 and 100 watts respectively and can be furnished in a variety of resistance values. Bulletin 107 explains how to select the proper size.

## RESISTORS



Brown Devils are wire wound, vitreous enamel covered units of the finest possible construction. The vitreous covering offers better protection against moisture and acid fumes than any other material. Insist on "Brown Devil" and avoid breakdowns.

## DIVIDOHMS

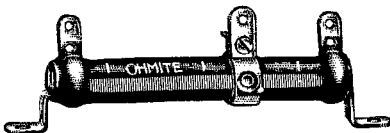

These adjustable resistors can be quickly adjusted to any desired resistance value by means of a ball-pointed adjustable lug. A patented scale makes resistance reading possible at a glance. Excellent for experimental work.

See Your Jobber or Write Today for  
Complete Catalog No. 16

# OHMITE

MANUFACTURING COMPANY  
4831 W. Flournoy St. Chicago, Ill.

circuit.  $L_2$ ,  $R_6$  and  $C_5$  act as the audio coupling unit.

A suitable amount of output is delivered from the 6C5 triode amplifier used, as explained before, to permit battery operation. If a.c. power supply operation is contemplated, output may be

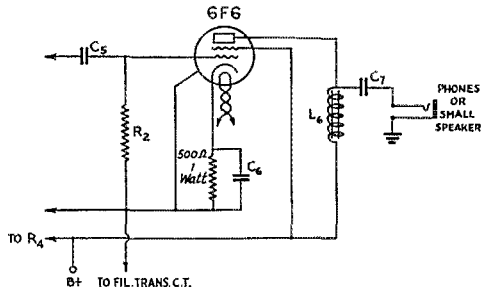

FIG. 2—A PENTODE AUDIO AMPLIFIER MAY BE SUBSTITUTED FOR GREATER OUTPUT WITH A.C. POWER-PACK SUPPLY

A choke-condenser output circuit protects the 'phones from the heavier plate current flow. The condenser should be of the paper type, rated at 400 volts and of 0.1 to 1  $\mu$ fd. capacitance. The choke may be a 30-henry 50-ma. type. Except for the 500-ohm 1-watt cathode resistor, other parts are the same as given in Fig. 1.

further boosted by replacing the triode with a pentode. This has been tried, the 6F6 being the particular tube used. Very few changes are required to make the conversion—voltage feed to the screen and a new cathode resistor doing the job, as shown in Fig. 2. However, for a dual purpose receiver—that is, battery and also a.c. operation—the 6C5 triode is the better tube. Its current drain is well below that of any pentode and it does work satisfactorily when used in conjunction with a 250-volt power pack.

Filaments of both tubes are connected in parallel and heated with a 6.3-volt filament transformer, the center tap of which is grounded to reduce hum. For portable work the heaters will of course be supplied from a six-volt storage battery, the alternative connection of which is indicated in Fig. 1. Voltages ranging from 135 to 250 volts may be used on the plates, the best values being 180 volts for battery work and 250 volts when used with rectified a.c. power supply.

### THE COIL ASSEMBLY

Three of the four coils are wound with No. 24 d.c.c. wire, while the fourth, the 1.7-Mc. coil, is wound with No. 28 d.s.c. The forms in each case are made from 1-inch bakelite tubing. The Coil Table specifies the length of the windings, the number of turns, and placement of the cathode tap. Two holes that will pass No. 14 tinned wire are drilled at each end of the form. When the tinned wire is threaded through these holes and bent over to form a clasp, we not only have points at which to start and end the windings but also means of mounting the coils on the switch. The cathode taps are most easily made by making a loop in the wire at the right place, scraping the insulation from the loop, and then twisting and soldering to add firmness, after which the winding is continued in the same direction. To the front



# BUY that NEW RECEIVER from GROSS RADIO—RECEIVER HEADQUARTERS

ALL SETS IN STOCK FOR IMMEDIATE DELIVERY—LIBERAL TRADE IN ALLOWANCES

Hallicrafter Sky Buddy.....	\$29.50
Hallicrafter Sky Chief.....	44.50
Hallicrafter S-15 Challenger.....	69.50
Hallicrafter SX-16 Super Skyrider with tubes, crystal, and speaker.....	123.50
RME-69 with tubes, speaker, and crystal.....	151.20
Hammarlund Super Pro SP-110 with tubes and speaker.....	238.14

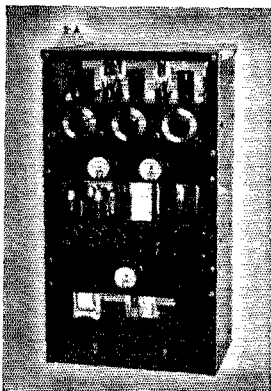

## NEW! CB-55 MODERATELY PRICED RADIOPHONE TRANSMITTER

FB. FOR 30 MC.

Input—95 watts. Uses—2-T20 tubes in R.F. and 6L6's in modulator. Coils available for 30, 14, 7, 3.5, and 1.7 mc.

*Descriptive bulletin on request*

## NEW! CW-55—uses 2-T20 tubes FB. for 30 MC.

Max-Output—70 watts  
42 osc., 6L6 Buffer  
2-T20's amp.

Coils can be supplied for 30, 14, 7, 3.5, and 1.7 mc bands. Complete kit, with one set coils, less tubes and crystal.....\$18.95

*Descriptive bulletins on request*

## New: L60 Beam Power (60 Watt) Modulator

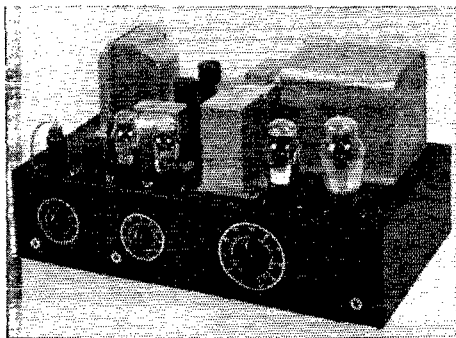

- 4 stages (1-6J7, 2-6C5, 2-76, 2-6L6, 1-45, 1-83)
- Push Pull second stage and driver for high fidelity
- Two channel, high and low gain high impedance inputs
- Built-in modulation transformer
- Fixed bias

This beam powered 60 watt modulator will 100% plate modulate transmitters with up to 120 watts input. The built-in modulation transformer will match R.F. loads of 5000, 8000, and 10,000 ohms. On special order we can supply this unit with output impedances of 4, 8, 15, 500 ohms for general public address work.

A two channel input permits full output with mixing from a crystal, ribbon or carbon mike. The tone control provided is used to attenuate voice or music frequencies to suit the requirements of best modulation. Chassis size: 19" x 11" x 4 1/2". Weight 50 lbs. Built-in extra heavy duty power supply.

Completely wired and tested in our lab., less tubes..... **\$42.50**  
Matched set of Sylvania tubes..... **\$6.50**

## NEW! "THE STANDBY" (2 TO 2000 METERS) 3-TUBE A.C. AND D.C. RECEIVER

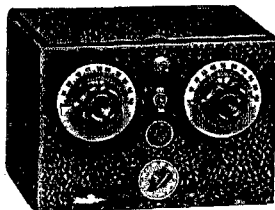

This excellent 2 to 2000 meter receiver is offered with full realization of the present-day need of the amateur for a dependable "standby" receiver which will cover practically all of the radio bands in use today. Super regeneration, which is the most efficient form of detection at these frequencies, is used from 2 to 15 meters. The R.F. stage is effectively used over the entire tuning range. Throughout the entire tuning range, there are no skips or dead spots. Loud speaker volume is available from practically every station received.

- 1000 to 1 tuning ratio
- Super regeneration below 15 meters
- Automatic change over from straight to super regeneration
- Power supply incorporated
- Individual antenna tuning for high and low wave ranges
- 1-6J5G detector, 1-6J7 R.F. stage, 1-12A7 audio amp and rectifier.

Complete kit of parts, less coils, tubes, cab.....	\$7.59
2-5-10 meter coils (set of 3).....	.95
9 1/2 to 15 meter coil.....	.39
15-200 meter coils (set of 4).....	.95
200-310 meter coil.....	.39
310-550 meter coil.....	.39
550-1050 meter coil.....	.60
1000-2000 meter coil.....	.60
Metal cabinet.....	1.50
Kit of three tubes.....	2.40
Wired and tested in our lab., add.....	2.00

≡ WRITE IN FOR FREE NEW CATALOG ON HAM AND P.A. EQUIPMENT ≡

20% DEPOSIT WITH ALL C. O. D. ORDERS      REMIT BY M. Q. INCLUDE POSTAGE      Cable Address: GROSSINC

## GROSS RADIO, INC., 51 VESEY STREET, NEW YORK CITY

# SPEER ANODES GIVE



## "MORE WATTS PER DOLLAR"

Speer Graphite Anodes help tube makers give you more for your money. Speer Processed Graphite Anodes cannot soften, melt, warp or distort at any temperature whatever. Speer Anodes are supplied only to manufacturers. For booklet on Graphite Anodes and list of tube makers who supply them, address:

**SPEER CARBON CO.  
ST. MARYS, PA.**



Ⓜ 77 29

section of the switch goes the common grid lead and to the other section goes the cathode lead. The coils are mounted with the cathode and grid leads going to their respective switch contacts. No. 14 wire is used to bring a lead from the grounded rotor plates of the condensers to the ground ends of the coils. Heavy wire should really be installed whenever advised and shown in the pictures; otherwise, a frail coil assembly will result. Unless the construction of this unit is as rigid as possible, operation and handling of the receiver will cause shimmying or shifting of the coils, upsetting any hope of stability.

General coverage of the combined four coils is from 1160 to 15,400 kc. Band-spread is so arranged that the 1.7-Mc. band covers just exactly the entire scale of the dial. The c.w. portion of the 3.5-Mc. band is also spread over the entire scale with the 'phone section of the same band requiring a small resetting of the band-set condenser. Both the 7- and 14-Mc. channels are allotted approximately fifty divisions of the dial.

All in all, this is not a bad little set to have around. Don't let its size, quantity of tubes, or inexpensiveness lead you to think that it doesn't deliver a sock, for signals have been copied from it while standing a good 25 feet from the 'phones. And remember that suggestion about emergency utility. You know that when the need arises, a transmitter can be thrown together in a matter of minutes. But the receiver—well, that's another story!

### DX Contest Results

*(Continued from page 26)*

Mc. . . . Spanish 'phone stations working in the 7-Mc. band engaged in War activities caused much grief for other Europeans. . . . Handicaps encountered by various contestants included a snowstorm and hurricane in Belfast during the last few days of the contest; GI6TK's skywire



**W5BEE, WINNER OF THE OKLAHOMA 'PHONE CERTIFICATE—FOR NEAT AND ORDERLY APPEARANCE THIS STATION CERTAINLY IS TOPS . . . AND THE RECORD. PROVES IT WORKS AS WELL**

came down from the 70-foot tree where it was fastened, and he had to put it up again as best he could—about 7 feet; he had to scrape ice several inches thick off the antenna two or three times a

# Rebuilding or Just Starting In

THE INFORMATION WILL BE FOUND IN

# THE RADIO AMATEUR'S HANDBOOK

★ FOURTEENTH EDITION ★

## Contents . . .

Hiram Percy Maxim . . . . .	Frontispiece
Foreword . . . . .	v
The Amateur — His Code of Ethics . . . . .	viii
Chapter One — The Story of Amateur Radio . . . . .	1
Chapter Two — Getting Started . . . . .	9
Chapter Three — Fundamental Electrical Principles . . . . .	17
Chapter Four — Radio Circuit and Wave Fundamentals . . . . .	34
Chapter Five — Vacuum Tubes . . . . .	51
Chapter Six — Receiver Circuit Design . . . . .	87
Chapter Seven — Receiver Construction . . . . .	114
Chapter Eight — Principles of Transmitter Design . . . . .	141
Chapter Nine — Transmitter Construction . . . . .	176
Chapter Ten — Keying . . . . .	205
Chapter Eleven — Fundamentals of Radiotelephony . . . . .	216
Chapter Twelve — Building Radiotelephone Transmitters . . . . .	228
Chapter Thirteen — Receivers for the Ultra-High Frequencies . . . . .	242
Chapter Fourteen — Ultra-High-Frequency Transmitters . . . . .	258
Chapter Fifteen — Power Supply . . . . .	275
Chapter Sixteen — Antennas . . . . .	300
Chapter Seventeen — Instruments and Measurements . . . . .	328
Chapter Eighteen — Assembling the Station . . . . .	342
Chapter Nineteen — Operating a Station . . . . .	351
Chapter Twenty — Message Handling . . . . .	366
Chapter Twenty-one — League Operating Organization . . . . .	379
Appendix . . . . .	389
Index . . . . .	417
Catalog Advertising Section . . . . .	425

**ONE DOLLAR POSTPAID IN CONTINENTAL U.S.A.**

*\$1.25 postpaid elsewhere*

*Buckram Bound \$2.50*



**American Radio Relay League, West Hartford, Conn.**

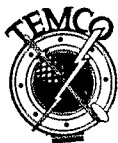

# TEMCO 350 TRANSMITTER

**FULLILLS PRESENT  
DAY OPERATING REQUIREMENTS  
WITH AMPLE POWER AND  
MULTIFREQUENCY FLEXIBILITY**

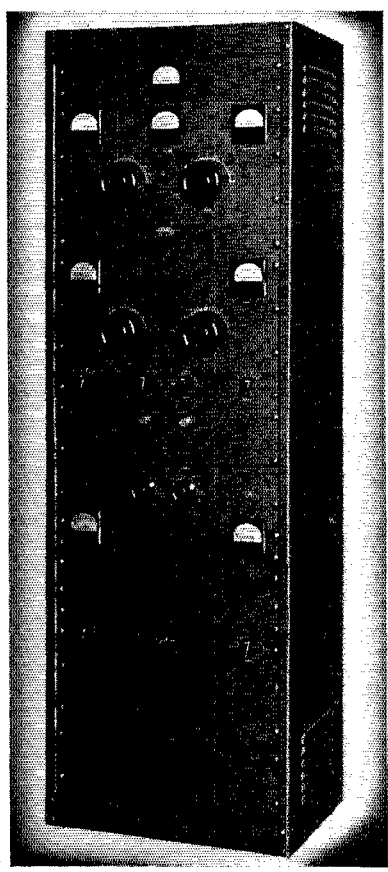

- 5 Band Switching Exciter Unit
  - Over-Abundance of Excitation
  - High Efficiency on All Bands
  - High Fidelity Transmission
  - Remote Control
  - Unsurpassed Workmanship
- Standard tubes are used exclusively in the circuits of all Temco Transmitters.

*Illustrated literature covering the Temco "100", "350", "600", and "1000" sent on request. Please indicate your power requirements.*

**TRANSMITTER**  
**Equipment Manufacturing Co., INC.**  
130 CEDAR STREET • NEW YORK, N. Y.

day. . . . The first evening W6CFK used a new beam antenna the gravel roofing became radio active and glowed so that a mail plane pilot thought the light was from a landing field; he saved himself just in time! . . . Common contest complaints: (1) CQ's by W/VE operators; (2) Too long calls; (3) Improper answering of directional CQ's. . . . Many foreign operators must have experienced the thrill of working more than one station at the same time. . . . D4ZZH tells of a double QSO with W6LAC and W9LJW, both on the same frequency. . . . W6FZL worked 64 different countries, W4CBY 62, W6GRL 62, W9ARL 61.

## The 'Phone Section

**I**N the C.W. contest the leading accessory was "wrist oil." In the 'Phone fray it was "cough drops"! The first 'phone DX Contest to be incorporated in an A.R.R.L. International Competition was a decided success. There was plenty of activity, and even the skeptics who didn't think they would like a 'phone DX contest must now admit it was plenty of sport. The leading operator in number of QSO's, W4AH, made nearly as many contacts as the C.W. leader—W4AH made 257 QSO's; W2UK (C.W. leader) 268 QSO's. This will give some idea of the extreme concentration of signals in evidence in the DX 'phone bands during the contest!

Highest W/VE scorer was Robert Henry, W9ARA, who "did the honors" to the tune of 45,445—253 QSO's on 14 and 28 Mc. with 42 different countries, a multiplier of 61. OM Henry operated almost the full time, 89 hours, 47 minutes, using 806's in the final with 1-KW. input. Nice work, OM. Gang, a toast to W9ARA!!

A reasonably close second was T. C. Wood, Jr., W4AH, who made 257 contacts with 46 different countries, 56 multiplier, for a total of 43,064 in 68 hours. W4AH ran 1 KW. to a pair of 150T's in parallel, making contacts on three bands (3.9, 14 and 28). FB, TCW.

Madison Rehm, W2HNY, operating W2UK placed third with 39,753, based on 211 QSO's with 44 different countries. P.P. '52's were used in the final with 550 watts input. This, like the other high scores, represents plenty of jaw exercise. A striking thing is that, unlike many lower scorers, not one of the three high complained of a "sore throat"! They can take it.

Other high scorers include: W3EMM 34,574; W2JME 32,147; W1SZ 28,594; W4CBY (W4DHZ, opr.) 26,235; W6ITH 22,836; W3CRG 21,276; W4AGB 21,024, W3AIR 19,950 and W9DKU 19,551.

The highest scorers in each W district: W1SZ 28,594; W2UK (W2HNY, opr.) 39,753; W3EMM 34,574; W4AH 43,064; W5BEE 15,480; W6ITH 22,836; W7AO 6989; W8GLY 18,258 and W9ARA 45,445. Highest VE: VE2FK 5056.

High in number of QSO's are: W4AH 257; W9ARA 253; W2UK 211; W3EMM 198; W2JME 177; W6ITH 173; W1SZ 165; W4CBY (opr. W4DHZ) 165; W2MJ 160; W2IXY 158;

# More GRID-MODULATED POWER OUTPUT from the HK-154

Compare  
GAMMATRON  
before

YOU BUILD YOUR RIG  
—AND GET THE  
MOST FOR YOUR MONEY!



**\$12.50**

AT YOUR  
DEALER'S

## LOW COST UHF TUBES

Type	Rated Plate Dissipation Watts	Grid Modulated Carrier Watts	PRICE	Carrier Watts Per Dollar
154 Gammatron	50	70*	\$12.50	5.6
Tube A	100	54	\$13.50	4.0
Tube B	55	31	\$8.00	3.9
Tube C	35	21	\$8.00	2.6
Tube D	50	22	\$10.00	2.2
Tube E	35	19	\$8.00	2.4

\* The Type 154 GAMMATRON is ideally suited to grid modulation. Because of its high overload capacity, conservative plate rating and its low amplification factor, the HK 154 far outstrips its competitors in the same price class for this purpose.

Because of its characteristics and because a release of plate supply power takes place during peaks, linear grid modulation is possible at efficiencies in the order of 50% with the HK 154; with other tubes of higher mu, efficiencies greater than 30 to 40% are unattainable.

Complete information on *just how* this can be done is yours for the asking.

**HEINTZ AND KAUFMAN**  
LTD

SOUTH  
SAN FRANCISCO

CALIFORNIA  
U.S.A.

**Say . . .  
RADIO AMATEUR!**

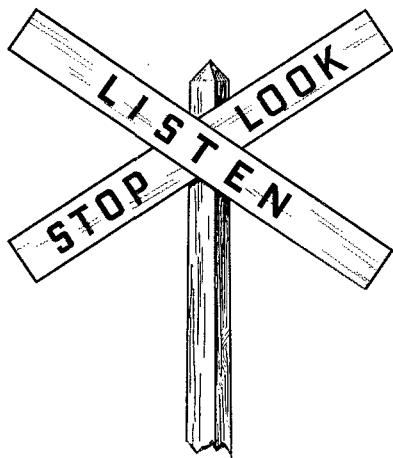

**A Sign LIKE THIS  
USUALLY INDICATES  
A R. R. CROSSING**

BUT  
IN THIS CASE  
IT IS USED  
TO CALL YOUR  
ATTENTION  
TO THE FACT  
THAT YOUR  
MEMBERSHIP IN  
THE AMERICAN  
RADIO RELAY  
LEAGUE  
ASSURES YOUR  
RECEIVING  
QST  
EVERY MONTH,  
REGULARLY.

**THE BOARD OF DIRECTORS  
A. R. R. L.**

W4AGB 152; W6BAY 147; W5BEE 146;  
W3CRG 134; W3AIR W9DKU 133 and W8GLY  
130.

Highest multipliers are credited to W2UK 63;  
W2JME W9ARA 61; W3EMM 59; W1SZ 58;  
W4AH 56; W3CRG 54; W3PC, W4CBY  
(W4DHz, opr.) 53; W8GLY 51; W3AIR,  
W4CYU 50; W9DKU 49; W4AGB 48; W1ADM,  
W2CBO, W3BLQ 45; W4TO, W6ITH 44,  
W9YGC 42 and W6GRX, W9BEZ 40.

**HIGH FOREIGN SCORES**

World high scorer in the 'phone section was  
XE2N—64,311 points, 566 QSO's, multiplier of  
39 made using 1.7-, 3.9-, 14- and 28-Mc. bands.  
Operation was for 50 hours, 50 minutes.

With a score so close that it deserves a hand  
almost equal to XE2N's accomplishment comes  
K6MVV in second place—63,180. He leads in  
number of QSO's—812—but slipped up on the  
multiplier; he used but two bands (14 and 28)  
and has a multiplier of only 26. Power at K6MVV  
was 83 watts, operating time 73 hours.

Third high is G6LK—36,176 . . . 355 QSO's,  
multiplier of 34. 3.9-, 14- and 28-Mc. bands were  
used during 65 hours of operation. To XE2N,  
K6MVV, G6LK—Congratulations!

Other scores worthy of note: VK2GU 24,096;  
LU9BV 18,400, PAØWV 14,952, G5JO 13,650,  
K6CGK 12,660, ON4ZA 12,408, CO2ON (CM2BJ,  
opr.) 12,138, EI2J 11,460 and HK1GK 10,697.

The highest scorers on each continent: Africa—  
ZU6P 8244; Asia—XU8HW 52; Europe—G6LK  
36,176; North America—XE2N 64,311; Oceania  
—VK2GU 24,096; South America—LU9BV  
18,400.

Leaders in number of QSO's: K6MVV 812;  
XE2N 566; VK2GU 368; G6LK 355; CO2ON  
(opr. CM2BJ) 293; LU9BV 269; G5JO 223;  
K6CGK 217; PAØWV 208; EI2J 205; HK1GK  
194; ON4ZA 193; VK2ABG 185; K7PQ 162;  
EI2L 160, VK3MR 157 and G2NH 155.

Highest multipliers were made by: XE2N 39;  
G6LK 34; K6MVV 26; PAØWV, VK2GU 24;  
LU9BV 23; ON4ZA 22, G5JO, PY2AC 21 and  
EI2J, EI2L, G2NH, K6CGK, VK3MR 20.

**GENERAL ITEMS**

The following made contacts on 3 bands:  
W1ADM, W1SZ, W2CBO, W3EMM, W4AH,  
W6BAY, W6EX, W6GRX, W7AO, VE5MQ,  
G6LK, K6CGK, K7PQ and PAØWV. . . .  
But two operators used 4 bands—W6ITH and  
XE2N. . . . "Yell and Listen Contest" is what  
W4DCQ calls it. . . . W6ITH worked a total of  
66 VK 'phones and made W.A.C. four times. . . .  
W6BKY worked 59 VK's out of 114 he had  
worked since March 25, 1936. . . . On the last  
morning of the contest W4AH worked 30 VK's  
and ZL's in 2 hours, 40 minutes. . . . One of the  
biggest laughs, according to W6ITH, was con-  
testants trying Spanish on South Americans only  
to be requested to use English! . . . On March  
22d W6AM worked all continents in one night  
on 14 Mc. . . . W6CQI's serial number was  
also his telephone number, so he invites any of the  
DX boys he worked to give him a call when and if

# PERSONALLY ENDORSED

by Chester H. Thordarson

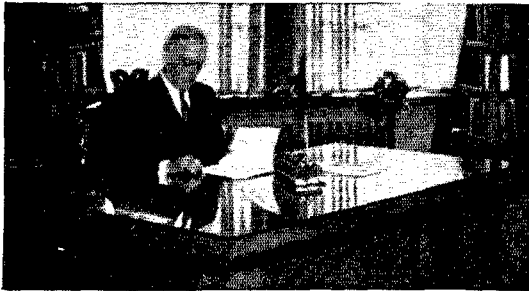

**THORDARSON**

**CHT**  
**SERIES**

## Endorsed Features

New Streamline Case, Moisture Proofed, Compound Filled

- **MULTI-MATCH MODULATION TRANSFORMERS**—Plug-in Terminals.
- **MULTI-MATCH DRIVER TRANSFORMERS**—Plug-in Terminal and Sub-base Lugs.
- **MULTI-VOLT PLATE TRANSFORMERS**—Primaries 115-230 volts—Tapped secondaries.
- **MULTI-VOLT FILAMENT TRANSFORMERS**—Tapped-Multiple Secondary Windings.
- **MULTI-VOLT BIAS SUPPLY TRANSFORMERS**—Choice of Secondary Voltages.
- **AUDIO TRANSFORMERS**—Hum Bucking Coil Construction.
- **CHOKES** Actual Rated Inductance at Full Load

**FREE** New Catalog No. 400A shows complete line together with amateur specials and standard series. At your Distributor or write Dept. Q-710 at the factory.

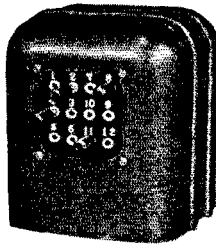

**MULTI-MATCH MODULATION**  
5 types, 40-500 watts

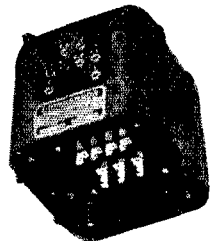

**MULTI-MATCH DRIVER**  
6 types, 15-30 watts

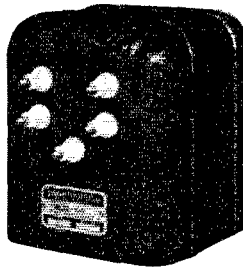

**MULTI-VOLT PLATE**  
12 types,  
500-3000 volts

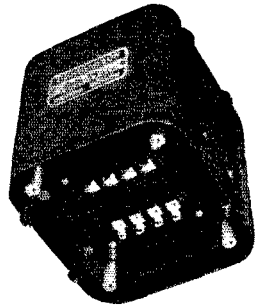

**MULTI-VOLT FILAMENT**  
3 single—3 tapped  
3 multiple types

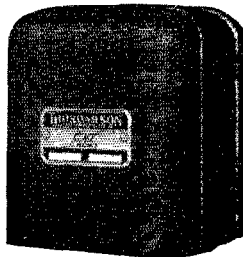

**INPUT AND SMOOTHING CHOKES**  
5 input—5 smoothing

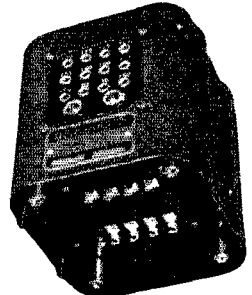

**MULTI-VOLT BIAS SUPPLY**  
3 types, 90-500 volts

**MULTI-VOLT POWER**  
4 types—Filament and plate windings.

**AUDIO COUPLING TRANSFORMERS**  
4 classes—10 types

— Not Shown —

**THORDARSON ELECTRIC MFG. CO.**

**500 W. HURON ST., CHICAGO, ILL.**

*Demand "Power by Thordarson"*

# YOURS FOR THE ASKING!

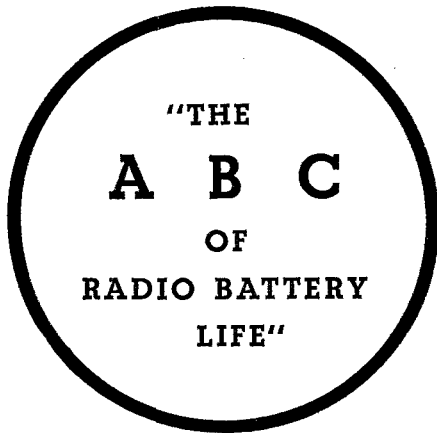

Send the coupon *today* for this handsome new booklet, illustrated in color, specially prepared for radio dealers, technicians.

Answers your questions:

- "How long will 'B' batteries last?"
- "How long will dry 'A' batteries last?"
- "How long will an 'AIR CELL' 'A' battery last?"
- "What brings 'Sudden Death' to 'B' batteries?"
- "How does the 'AIR CELL' 'A' battery breathe?"
- "How does a dry cell produce electricity?"

*Tells you:*

- How to cut "A" power costs in half.
- How to increase tube life two to three times.
- What to do about "voltage wasters".
- What you should promise your customers.



NATIONAL CARBON COMPANY, INC.  
P. O. Box No. 600, Grand Central Station  
New York, N. Y.

Please send me free of charge the new book:  
"The ABC of Radio Battery Life."

Name \_\_\_\_\_

Address \_\_\_\_\_

QST-2

they arrive in town. . . . March 28th was a big day for HB9J; on that date he worked W5ASG, W6BAY and W7AO for the first 'phone contacts between Switzerland and the W5, W6 and W7 districts. . . . On the same occasion he worked all W districts on 'phone within 1 hour, 54 minutes; included also in this time was a QSO with OA4R, the first HB/OA 'phone contact. . . . This was all on 14 Mc. . . . One of the worst contest locations was W8GLY's—in a large industrial plant, some several hundred noise manufacturing machines in operation from 7 A.M. to midnight, and adjacent to the main garage for a motor coach company. . . . W2JME worked 46 different countries, W1SZ 43, W3EMM 42.

#### CLUB SCORES

Winner of the gavel award to the amateur radio club having the greatest collective score (sum of both c.w. and 'phone scores) in the Ninth International DX Competition is the Tri-County Radio Assn., Inc., of Plainfield, N. J. Twenty operators in this organization submitted a total of 281,718, more than one hundred thousand points ahead of their nearest competitor. An excellent showing, T.C.R.A.! W2JME was winner of the individual club certificates for both c.w. and 'phone within the Tri-County Club.

Other clubs making good showings in the club competition follow in order of the combined scores of all participating members. The calls given in parenthesis with the club names are winners of the club certificates within their respective organizations; unless otherwise stated certificate was won in the C.W. Section. . . . 20-40 Club (Los Angeles) (W6FZL) 144,245; Trenton (N. J.) Radio Society (W3EDP c.w.; W3AIR 'phone) 93,039; Schenectady (N. Y.) Amateur Radio Association (W2CBO) 70,653; Twin-Borough Amateur Radio Association (Roselle, N. J.) (W2DJT) 61,507; Chicago Radio Traffic Association (W9KA) 58,493; Southtown Amateur Radio Association (Chicago) (W9PK operating W9AFN) 44,889; Northern Nassau Wireless Association (N. Y.) (W2AHC) 44,139; Oakland (Calif.) Radio Club 40,625; Central Illinois Radio Club 34,443; Mountaineer Amateur Radio Association (W. Va.) (W8KKG) 33,383; South Jersey Radio Association (W3ZX) 29,590; Winston-Salem (N. C.) Amateur Radio Club, Inc. (W4ABT) 26,499; San Francisco Amateur Radio Association 22,880; Wichita (Kans.) Amateur Radio Club 21,260; 100 What Club (Modesto, Calif.) 21,132; Rochester (N. Y.) Amateur Radio Association 17,829; Elmira (N. Y.) Amateur Radio Club 17,407; Fort Wayne (Ind.) Radio Club (W9LKI) 15,840.

In addition to the above, individual C.W. club awards are being made to these amateurs: W1APA, Bridgeport (Conn.) Amateur Radio Club; W2IOP, Brooklyn Technical High School Radio Club; W3ATR, Beacon Radio Amateurs, Philadelphia; W4DIQ, Jacksonville (Fla.) Radio Club; W8DLT, Genessee County (Mich.) Radio Club; W8ENH, Dayton (Ohio) Amateur Radio Assn.; W8GKG, C.E.I. Radio Club, Cleveland,



# CHIRAD — 16 NATIONAL — 23

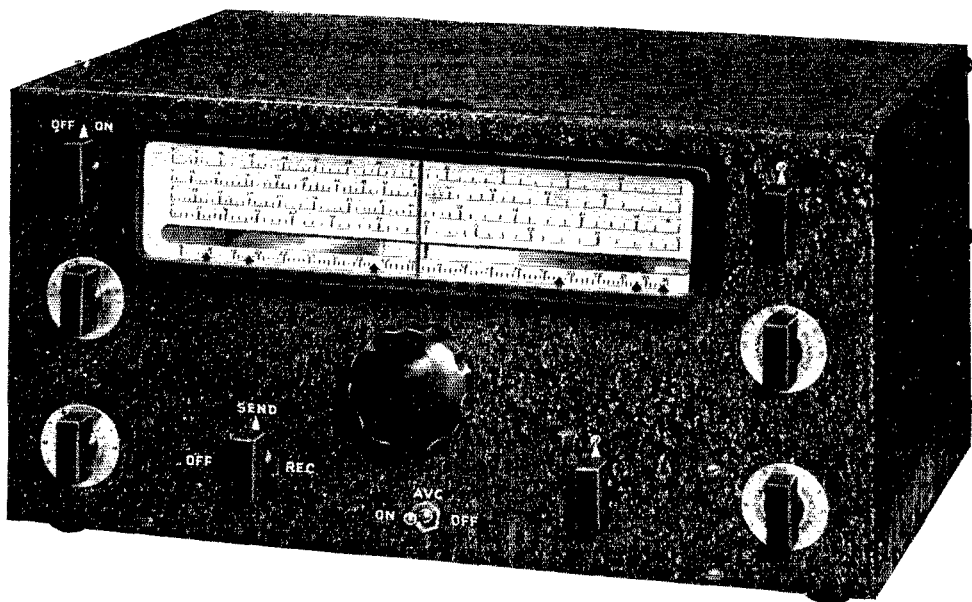

## NO HAMS! THAT IS NOT A FOOTBALL SCORE!

*Each figure shown above represents the number of years which that company has been guaranteeing amateur equipment.*

### A DOUBLE GUARANTEE

The New National NC 80X and NC 81X Amateur Communication Receivers carry the same *double guarantee*.

### EASY PAYMENT PLAN

Own this famous National receiver with a nominal down payment and monthly payments to suit your convenience. Liberal trade-in on your old receiver. Complete with Tubes, Crystal Filter, 8" P M Speaker Chassis. **\$88.00** Only.....

### EXPERT ADVICE

Play safe — buy from CHIRAD with satisfaction guaranteed — the house that has *NEVER* disappointed a buyer.

*All National NC 100X and HRO receivers carried in stock*

**CHICAGO RADIO APPARATUS CO.**  
415 SO. DEARBORN ST., CHICAGO • Est. 1921 • W9RA & W9PST



## RK-20A

### AN IMPROVED PENTODE FOR MEDIUM POWER OUT- PUT AND DRIVER USE

*Hard Glass Bulb*

*7.5 Volt, 3.25 Ampere  
Thoriated Filament*

*Excitation Required, 0.9 Watt*

*Class C Power Output, 80 Watts*

*Suppressor Modulated Phone  
18 Watts*

*Grid-Plate Capacity  
0.012 MMF*

*No Neutralization Required*

### NEW AMATEUR NET PRICE

# \$15<sup>00</sup>

The RK-20A is only one of a complete line of tubes designed especially for the Amateur. See your dealer or write the nearest Raytheon office for data on the RK-20A and on the new "Beam Power" RK-47 and RK-48 Raytheon Amateur Tubes.

## RAYTHEON PRODUCTION CORPORATION

55 Chapel Street . . . . . Newton, Mass.  
420 Lexington Avenue . . . . . New York, N. Y.  
445 Lake Shore Drive . . . . . Chicago, Ill.  
415 Peachtree St., N. E. . . . . Atlanta, Ga.  
555 Howard Street . . . . . San Francisco, Cal.

Ohio; W9GIL, Milwaukee Radio Amateurs Club; W9HFK, Hamfesters Radio Club of Chicago.

#### CONCLUSION

In a contest as successful as the Ninth International there is little left to be said after complete results have been put down on paper. And no one will question the great success of this 1937 DX Contest, both the C.W. Section and the 'phone Section. We could gripe about poor operating; there was enough of it observed during the contest. But, rather, let's each resolve to do our part to eliminate poor operating in the future. Above all, let us zealously guard against a repetition of the flagrant off-frequency operation prevalent in this contest. If your call isn't listed in the final scores, look back in May *QST* and see if you were one of those operators disqualified for infraction of the regulations. In fact we refer every DX contest enthusiast to that May issue wherein By Goodman presented an interesting preliminary report on the contest (page 9) and where Comms. Mgr. Handy discussed "DX Competition Policy"; there are points given with which we should all be familiar.

How to make a winning score in future contests? Well, our suggestion is to give thought to a number of things—good antennae, good receiver, frequency flexibility, ability to change bands quickly and efficiently, break-in and push-to-talk, proper choice of operating hours and an all around general knowledge of good operating practice. If you get these things down pat, you'll be on the road to the top.

#### Scores

##### Ninth International DX Competition

(Operator of the station first-listed in each Section and Country is winner for that territory, unless otherwise indicated. . . . Asterisks denote stations not entered in contest, reporting to assure credit for stations worked. . . . The multiplier used by each station in determining score is given with the score—in the case of W/VE entrants this is the total of the different countries worked on each frequency band used; in the case of non-W/VE participants it is the total of the different W/VE Districts worked on each frequency band. . . . The number of bands on which successful contacts were made is next listed. . . . The letters A, B and C approximate the power input to the final stage at each station; A indicates power up to and including 100 watts; B indicates over 100 watts, up to and including 500 watts; C indicates over 500 watts. . . . In cases where power was varied, this is shown by the use of more than one letter. . . . The total operating time to the nearest hour is given for each station and is the last figure following the score. . . . Example of listings: W3ENX 45908-92-4-C-70, or, Final Score 45908, multiplier 92, 4 frequency bands used, power over 500 watts, total operating time 70 hours. . . .)

#### C.W. Scores

##### ATLANTIC DIVISION

##### E. Pennsylvania

W3ENX	45908-92-4	C-70	W3AAL	4640-32-3	A-66
W8MAH	31408-79-4	A-87	W3CUB	3915-29-1	C-42
W3CHEH	24978-69-4	BC-51	W3FLH	2730-26-3	BC-34
W3EYV	20894-62-3	B-83	W3CBK	2700-25-3	A-32
W3FGB	15903-56-4	AB-50	W3CWU	2664-24-2	B-29
W8OKC	13091-53-3	B-35	W3OP	2442-22-1	B-23
W3KT	11500-46-2	B-51	W3AOA	2345-23-3	B-23
W3DPU	7850-39-3	BC-48	W3FWH	2139-22-2	B-32
W3BQP	7485-36-1	B-55	W3GSS	2047-23-1	B-26
W3CZO	6480-36-2	B-31	W3BND	1767-19-2	A-B-13
W3BML	5445-33-3	B-26	W3ANZ	1728-18-1	C-22
W3ATR	4930-34-3	B-44	W3GMS	1506-19-1	B-25
			W8MDW	1404-18-1	A-13
			W3FUH	1377-17-1	A-34

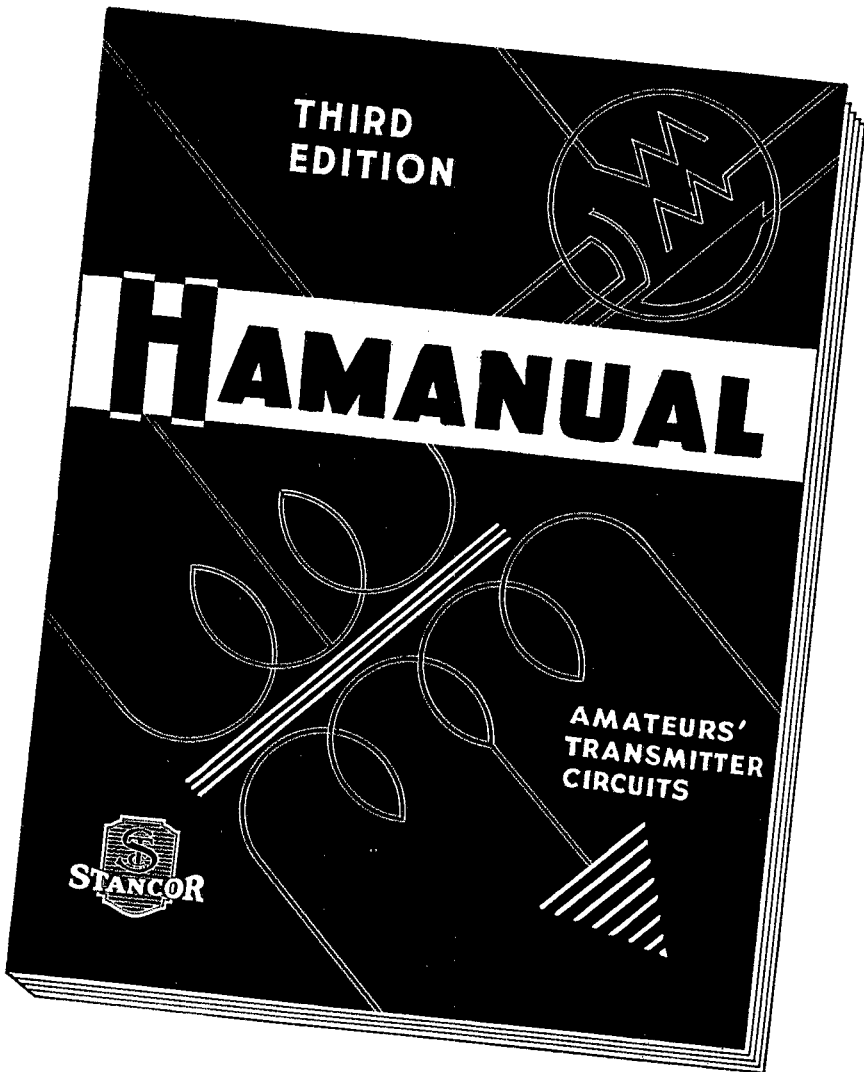

# **READY OCTOBER 1<sup>ST</sup>**

## **GET YOUR COPY FROM YOUR JOBBER**

Brand new... from cover to cover! New tubes, new circuits. Full data on the STANCOR LINE, now the most complete line available. 16 NEW TRANSMITTERS with a complete power range from 5 watts to 1 KW. . . . Ask your jobber for your copy. If he cannot supply you, just drop us a post card. We'll send it direct.

**STANDARD TRANSFORMER CORPORATION**  
850 BLACKHAWK STREET CHICAGO

Say You Saw It in QST — It Identifies You and Helps QST

# ASTATIC

## New "Acorn" Model T-3 CRYSTAL MICROPHONE

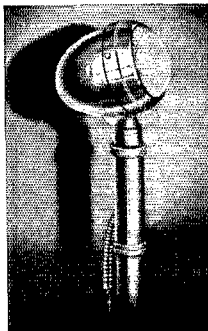

Unique tilting mount permits uni- or non-directional pickup without disturbing frequency response. No yoke and no annoying cable entanglements or breakage. Single diaphragm type for high class broadcast, recording or amateur use. Exceptional directional characteristics. Acoustic feedback definitely reduced. Attractively shaped. Beautiful polished chromium finish. Complete with Astatic exclusive interchangeable plug and socket cable connector and protector. Fully guaranteed.

**LIST PRICE \$25.00**

SEND FOR LITERATURE on other new Astatic Microphones including unique "GRIP-TO-TALK" Model CD-104, for air-way ground stations, inter-office, inter-factory, amateur and other similar communicating systems.

Licensed under Brush Development Co. Patents  
**ASTATIC MICROPHONE LABORATORY, INC.**  
DEPT. G-2, YOUNGSTOWN, OHIO, U. S. A.  
Pioneer Manufacturers of Quality Crystal Devices

**5 METER FANS!**  
WORK 5-10-20 METERS  
AT WILL WITH THE  
CRYSTAL-CONTROLLED  
STREAMLINER



FINAL R F  
AMPLIFIER  
AND  
ANTENNA  
TUNER

EXCITER  
UNIT  
(CRYSTAL  
OSCILLATOR,  
BUFFER AND  
DRIVER)

POWER  
SUPPLY  
UNITS



**GENERAL  
TRANSFORMER CORP.**  
1988 W. Van Buren St. Chicago

ASK YOUR JOBBER OR WRITE FOR FREE BULLETIN 48

W3FTQ	1173-17-1	B-13 <sup>1</sup>	W3FTK	1350-18-3	A-20
W3GKH	1134-14-2	A-29	W3ELG	1080-15-2	AB-20
W3BPM*	1050-14-1	B-14	W3BNZ	756-12-1	B-11
W3DGM	915-15-2	A-27	W3GGL	561-11-1	B-13
W3AGV	836-11-2	---	W3BEI	342-9-1	--13
W3CYC	825-15-3	A-44	W3AWH	333-9-1	A-11
W3FXZ	702-13-1	B-27	W3DPE	288-8-1	B-49
W3FRS*	561-11-3	B- --	W3BYK	203-7-1	B-8
W3EZH	506-11-2	A-23	W3FXV	90-5-1	B-15
W3ECA	490-10-1	A-7 <sup>2</sup>	W3FFE*	45-3-2	-- --
W3EDC	420-10-2	A-7			
W3BPY*	360-10-2	---			
W3AJH*	336-7-2	---			
W3BPN*	288-8-1	---			
W3FXC	264-8-3	---			
W8FLA*	189-7-2	A-5			
W3FWB	180-6-1	B-12			
W3EJM*	162-6-1	---			
W3GGT	105-5-1	A-7			
W8CZF	60-4-1	A- --			
W3DYL	24-2-1	A-2			
W3EWJ*	12-2-1	---			
W3FVC	3-1-1	A- --			
W3FWH*	1-1-1	---			

### W. New York

W8AU	32904-78-3	B-65
W8LDA	19175-50-3	B-59
W8LDO	18410-60-3	B-82
W8DOD	17820-61-3	A-42
W8CPT	14920-52-2	B-44
W8CJH	13311-51-1	C-64
W8EMW	13680-44-3	B-56
W8BOJ	6804-36-1	B-63
W8BFG	5472-32-1	B-42
W8CKY	5247-32-2	B-43
W8KAU	4554-33-1	A-22
W8DHH	4006-31-3	C-76
W8NQC	3800-25-2	A-20
W8BLL	3750-25-1	A-25
W8BQJ	3709-24-1	B-29
W8HTV	2920-20-1	A-63
W8OMA	1530-18-2	--55
W8FMX*	1184-16-2	A-16
W8QHX	1140-15-2	A-18
W8PFX	1008-14-1	B-43
W8EBR	966-14-1	B-6
W8LGO	966-14-1	A-16
W8QKM	756-12-1	A-58
W8PFM	720-12-2	A-37
W8CBE	398-10-1	B-9
W8ADG	270-9-1	B-5
W8JUF	264-8-2	A-10
W8GWT	240-8-1	B-11
W8GQY	264-8-1	B-6
W8GJV	168-7-1	B-6
W8EDA	120-5-1	A-4
W8EHO	105-5-1	---
W8OXH	64-4-1	A-4
W8AFE*	48-4-1	---
W8PCM	10-2-1	--9
W8LGV	9-1-1	B-2
W8HQW	3-1-1	B- --

### Md.-Del.-D. C.

W3GEH	16575-51-1	C-89
W3BEN	11960-46-1	B-75
W3EPR	11679-51-4	B-58
W3HC	10272-48-4	B-56
W3EEB	9495-45-3	B-80
W3EJH	9240-44-3	B-64
W3EJU	7488-39-2	C-47
W3APJ	5180-28-2	B-45
W3CDG	5146-31-2	B-36
W3EVP	4851-33-2	B-44
W3E5P	2838-22-3	--60
W3AMQ	2284-23-1	B-38
W3FDJ	1596-19-3	B-20
W3DQU	1560-20-2	A-28
W3CYO	1501-19-2	B-29
W3FYS	1200-20-1	A-29
W3CBV*	936-14-1	B-12
W3AFU	840-14-2	B-16
W3COK	468-12-1	A-8
W3FQB*	264-8-1	B-6
W3CDQ	252-7-1	B-17
W3FSP	184-8-2	A-10
W3BVO	90-5-2	A-14
W3DRD	27-8-2	B-19

### So. New Jersey

W3PC	56304-102-3	C-82
W3EDP	37584-87-4	B-37
W3AIR	34080-80-3	B-62
W3FKK	31080-74-3	C-58
W3CGU	30324-76-3	B-69
W3AIU	28012-64-2	B-66
W3ZX	18483-61-3	BC-62
W3DOK	8680-35-2	B-72
W3ECO	6552-35-2	B- --
W3CBR	5955-35-3	B-44
W3EYT	3480-29-1	B-37
W3EXB	3240-24-1	B-16
W3BVE	2625-25-2	B-30
W3EBC	2568-24-1	B-16
W3FRE*	2454-23-1	---
W3CRG	1620-18-2	B-19
W3GJP	1536-16-1	B-36
W3DAJ	1350-18-1	B-16

### W. Pennsylvania

W8ILL	28032-73-3	C-89
W8CTE	21420-70-3	B-60
W8OKK	17751-61-3	BC-70
W8IXS	14363-53-3	A-86
W8HRD	7872-41-2	B-59
W8OYK	6240-39-3	B-29
W8APQ	2511-27-5	A-52
W8QAN	2093-23-1	B-22
W8AAT	2028-26-1	---
W8BKH	1156-18-1	B-27
W8OUK	1037-17-2	A-5
W8FSZ	627-11-2	B-25
W8NRE	378-9-1	A-15
W8JSU	315-7-2	A- --
W8BSE	279-9-1	A-22
W8NQL*	126-6-2	A-8
W8LED	75-3-1	B-29
W8V1	65-5-2	B- --

<sup>1</sup> Three contacts by a second opr., <sup>2</sup> W3EQA. <sup>3</sup> Two opr. score. <sup>4</sup> Four opr. score. <sup>5</sup> Sheboygan Radio Amateur Club; oprs. -- W9BHO JDP NPT NVA NZP URM. <sup>6</sup> Two opr. score; W9SJK 966. W9EFK 192. <sup>7</sup> W2JGH. opr. <sup>8</sup> Four opr. score; W2HYM 2842. GFF 812. JFC 2744. JOG 360. <sup>9</sup> Two opr. score; W9WDU 424. ESY 27. <sup>10</sup> Two opr. score; WIBCG. CNU. <sup>11</sup> Trinity College Radio Club; oprs. -- W1LLA ILLI GKX. <sup>12</sup> Portable at Middletown, Conn. <sup>13</sup> Member A.R.R. <sup>14</sup> Highlights for contest awards. <sup>15</sup> Two opr. score; W1WY approx. 50,000 pts. <sup>16</sup> Two opr. score; WIHER. JRH. <sup>17</sup> Portable at Newton, Mass. <sup>18</sup> Two opr. score; W1LHJ 882. W1LNO 168. <sup>19</sup> Portable at Missoula, Mont. <sup>20</sup> Two opr. score; W1TS. RT; Washington award withheld pending more information on individual opr. scores at W1TS. <sup>21</sup> Echo Epistol Fraternity, Univ. of Wash.; oprs. -- W7AYO ENW EGM ETV BDW CSE BTW LD AEA EBJ 9BTJ. <sup>22</sup> Winston-Salem Amateur Radio Club; W4CTP. opr. <sup>23</sup> Portable at Gainesville, Fla. <sup>24</sup> Tech. High Radio Club, Atlanta; oprs. -- W4YO EFS ELR EMX EJJ. <sup>25</sup> Portable at Idylwild, Calif. <sup>26</sup> Portable at Gila Bend, Ariz. <sup>27</sup> W5FCQ and W5FV. oprs. <sup>28</sup> Three opr. score; W5GUA FEV FLE; Oklahoma award withheld pending more information on individual scores at W5YJ. <sup>29</sup> British Columbia Amateur Radio Assn.; oprs. -- VE5EP JH EN FA RS PT. <sup>30</sup> Score of opr. Walter Borg; opr. Jean Marcellie -- 2421. <sup>31</sup> Single opr. score; combined score of two oprs. -- 110,808-47-4-8-92 (score corrected for over 20 hours operation). <sup>32</sup> Mobile; attached to C. Z. for purposes of the contest. <sup>33</sup> Portable in Indiana. <sup>34</sup> W8ONK. opr. <sup>35</sup> Denison Univ.; W8EDU. opr. <sup>36</sup> W2HNY. opr. <sup>37</sup> Four opr. score; W9OQP DFY PV MVG. <sup>38</sup> Portable at Dodge City, Kans. <sup>39</sup> Portable at Bozeman, Mont. <sup>40</sup> Score of opr. Evans, W4DZH; opr. Benning, W4CBY -- 128 pts.; combined score, two oprs. -- 23461. <sup>41</sup> Score of opr. W9EFC. opr. <sup>42</sup> Score of opr. Tony Gettleman; opr. Marcel Lagrue -- 399; combined score of two oprs. -- 3284. <sup>43</sup> CM2BJ. opr.

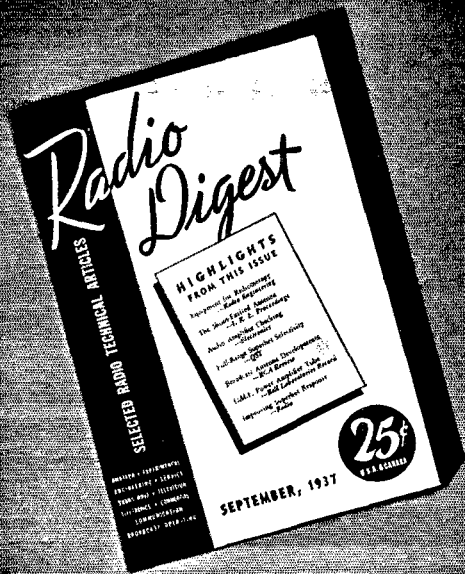

from this  
file of the  
**world's  
leading**  
technical and  
constructional  
**radio  
magazines**

"RADIO DIGEST" will review, reprint, or condense the outstanding contributions from the following magazines, from many of which "Radio Digest" has first choice ahead of all others in its field. In addition, the leading foreign journals and trade and house organs will be combed regularly for unusual material.

Radio  
QST  
All-Wave Radio  
Radio Engineering  
Communications and  
Broadcast Engineering  
Service  
Electronics  
Successful Servicing  
Radio News  
Bell System Technical  
Journal  
Bell Laboratories  
Record  
RCA Review  
Proceedings of  
Institute of Radio  
Engineers  
The Radio Engineer  
Broadcast News  
Revista Telegrafica  
Radio Review  
T. & R. Bulletin

# RADIO DIGEST

The technical world at a glance—the outstanding radio developments of the month at your finger tips—the highlights from the leading radio magazines of the world, American and foreign. That, in short, is the "RADIO DIGEST" a new 100-page publication. It is something entirely new in the field—a magazine for the busy man who wants the broad scope of what's going on in the whole world of radio (except b.c. entertainment and trade news)

*One of its most valuable features (alone worth many times the subscription price) is a series of "thumb nail sketches" of all important material in leading contemporary magazines, a comprehensive glossary of current radio literature.*

PRICE, 25c PER COPY

Special introductory subscription rate, \$2.00 for twelve issues (or six for \$1.00) in U.S.A., Canada, and Pan-American countries. Elsewhere, \$2.50 or 10s. 4d. (British postal orders accepted) for twelve issues.

To RADIO DIGEST,  7470 Beverly Blvd., Los Angeles

Enter my subscription for ..... issues. Remittance is enclosed herewith.

Name.....

Address.....

City..... Call.....

*Special*  
**\$1.00**  
for six  
issues

in U.S.A. Canada, and  
Pan-American coun-  
tries. Elsewhere, \$1.25



# Free CALL LETTER LAPEL PIN



Your favorite Distributor, cooperating with Taylor Tubes, offers all amateurs, absolutely FREE, a genuine W1DNF lapel pin. Think of it: *Your own* call letters on a beautiful, substantial, nickel silver lapel pin 1" x 1/4". This Taylor Tubes offer is in effect on all purchases from October 1, 1937 to December 31, 1937.

## READ THE RULES

You can only secure these fine lapel pins through an authorized Taylor Tubes distributor. No direct orders will be accepted. Tear off the tops from *two* Taylor 866, T-20 or TZ-20 cartons, or the top from *one* of any other Taylor Tube carton except the 866 Jr. (866 Jrs. are not included in this offer.) Present the tops to your favorite authorized Taylor Tubes Distributor. Within a short time he will have a lapel pin for you, *absolutely FREE*. This celebration offer is in appreciation of the tremendous sales success of Taylor Tubes throughout the past year. Your Distributor and Taylor Tubes are sharing in this great celebration.

## SEE YOUR DISTRIBUTOR TODAY

He will give you the complete dope. Hurry up, this offer expires midnite, December 31st. If you can't see your distributor in person, drop him a note and he will tell all.

New Taylor Manual acclaimed the finest by thousands. Don't delay—get your copy FREE from your Distributor or write to us.



Guaranteed Actual Size

"More Watts Per Dollar"

Taylor HEAVY **CUSTOM BUILT** DUTY Tubes

TAYLOR TUBES, INC., 2341 WABANSIA AVE., CHICAGO, ILLINOIS







# PRESENTING

## **SAM SCHWARTZ**

P R E S I D E N T

## **SUN RADIO CO.**

227 FULTON STREET

NEW YORK, N. Y.

Some folks believe in luck, others think we make our own "breaks", but . . . whether you believe in lady luck or not . . . you must admit that Standard Transformer Corporation is fortunate to be able to announce the appointment of Sun Radio Co. as Stancor distributor in the New York area.

Sam Schwartz and Sun Radio are well and favorably known throughout the east. You'll like the service they give . . . you'll like the product they sell. So . . . maybe we're *all* lucky.

A stylized, handwritten signature in black ink, appearing to read "J. J. Kahn".

**STANDARD TRANSFORMER CORPORATION**

850 BLACKHAWK STREET . . . CHICAGO



# A NEW THRILL IN RADIO

## CODE CONQUERED WITH THE AMERICAN CODE READER

Patent Applied for



HAVE YOU A PUNK  
FIST? WATCH IT AND  
IMPROVE IT WITH  
AMERICAN CODE  
READER.



GOV'T REQUIRES A  
LOG OF ALL MES-  
SAGES SENT AND RE-  
CEIVED BY HAMS. IT'S  
A SIMPLE TASK WITH  
AMERICAN CODE  
READER.



BE THE ENVY OF  
YOUR FRIENDS. JUST  
GET UR YL A CODE  
READER & TK TO HER  
IN CODE ON SHORT  
WAVE.



NOT GOOD AT  
COPY? AMERICAN  
CODE READER COPIES  
FOR YOU!!



AND NOW YOU CAN  
GET IN ON ALL THE  
SPEED THAT COMES  
OVER!

### ANNOUNCING A SENSATIONAL NEW "FISTMAKER" THAT WILL MAKE YOUR STATION OR LISTENING POST COMPLETE!

The enthusiastic praise with which the American Code Reader has been received proves the long felt need which it fills. Amateurs and Beginners alike marvel that such efficiency, such genuine service can be rendered by a device in this price class... a price well within the reach of every licensed amateur and beginner.

#### SIMPLE TO USE

The American Code Reader is simple in its operation. Simply connect the Code Reader to the voice coil leads on the loud speaker transformer in the radio receiver. Signals are fed into the recorder and converted into DC impulses which in turn are fed to the stylus which records dots and dashes electro-chemically on an electric motor-driven tape. The motor does not produce radio interference.

#### FOR THE AMATEUR

The licensed amateur can use the American Code Reader for making permanent records for QSO's, thus supplementing the usual station log. He can use it for checking his own

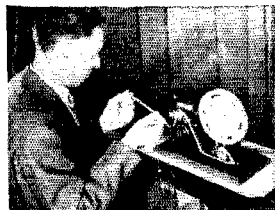

"fist" or those of others. Now the amateur can get all the speed that is thrown at him, for the Code Reader will record up to 100 words per minute. By means of a photo-electric cell he can play-back, for supervised automatic transmission thru his own rig.

#### FOR THE BEGINNER

For the beginner just breaking in, the American Code Reader is a big help. It is so designed that a standard telegraph key, connected in series with a 4.5 volt dry cell, may be connected to the input for personal tape recordings. Those studying for Class B amateur exams can practice sending to improve the fist. By using it with the American Audio Oscillator, the beginner can see and hear his fist at the same time.

#### ADVANTAGES

Unlike other recording devices, the American Code Reader uses no ink. Therefore, there is no smudging, no blotting, no punching. Recordings may be made permanent or temporary by means of a variable potentiometer. Its low list price of \$20 (including one 100 ft. roll of special tape) is among its most attractive features. Additional tape replacement rolls of 250 feet may be purchased for 25c each.

#### ASK FOR DEMONSTRATION

See the American Code Reader today at your Dealer's. Inspect its many advantages. If your Dealer has not yet received his supply, write us direct (with his name and address) and we will see that you are supplied.

**AMERICAN COMMUNICATIONS Corp.**  
1650 Broadway Code Reader Division New York, N. Y.

# SYMMETRICAL

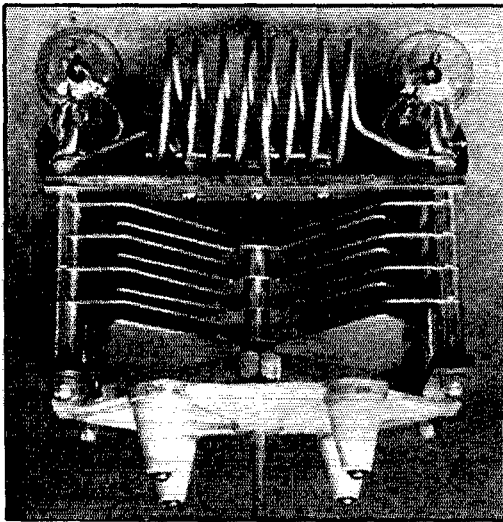

**MODEL ABC 6025 — 1¼ in. long**

- 60-60 mmfd. 250 inch airgap
- Ceramic standoffs included
- Leadless mycale insulation
- Built to hold your inductances
- A symmetrical UNIT designed to simplify your mechanical and electrical problems at the higher radio frequencies.

For quality condensers buy

**ATKINS & BROWN**  
 BW 6 V X 215 14th Street, Oakland Calif. W 6 H



## GORDON NAME PLATES

**ANTENNA TUNING**

A complete line of 106 beautiful, chromium plated name plates, available in two sizes. Write for listing and low prices on these ever-lasting name plates for Transmitters, Sound and Test equipment.

You're there ON TIME with a World-Wide clock! One quick glance gives you Standard or GMT time, accurately—instantly—for any one of the twenty-four time zones around the world.

This 24 hour time-piece, has a genuine Waltham movement. Attractively colored dials plainly marked for direct reading. Self starting. Operates on 110 volt, 60 cycle, AC.

Here is a beautiful, practical instrument you'll be mighty proud to own! Black satin-finished metal base, removable for flush-mounting in your panel. (Hole size 3-11/16"). Only \$9 net to licensed hams. Get yours today! See your jobber. Inquiries invited.

**GORDON SPECIALTIES COMPANY**  
 440 SOUTH DEARBORN STREET • CHICAGO, ILLINOIS

W7AOD	5985-35-3	C-51	W6OFD	300-10-2	B--
W7GBI	1728-18-2	B-35	W6PEP	240-8-2	A-11
W7EWR	594-11-2	B-16	W6DTJ*	5-1-1	---
W8NCQ	3-1-1	A-19			
<b>Oregon</b>			<b>ROANOKE DIVISION</b>		
W7AMX	28875-75-3	B-74	<b>North Carolina</b>		
W7AOL	3335-23-2	A-71	W4AH	57018-102-4	C-87
W7AMQ	2484-23-1	BC-50	W4ABT	16017-57-3	B-56
W7FUR	2160-20-2	B-58	W4CEN	13104-52-2	B-27
W7DZL	1760-20-2	B--	W4TO	12826-48-2	B-39
W7EZX	517-11-2	A-7	W4OG	9288-43-2	B-62
W7FH	270-9-1	B-12	W4RA	4698-29-2	B-63
W7BTH	168-7-2	B-5	W4CEI	4590-30-2	B-40
W7DAA	132-4-1	B-9	W4OC	1404-18-2	C-8
W7EHT	60-4-2	B-8	W4CCH	1136-16-1	B-21
W7DBY*	48-4-2	---	W4CJN	1125-15-1	B-38
W7CQF*	42-3-1	A-5	W4NG	755-14-1	B-27
W7FMX*	12-2-1	---	W4BVD*	561-17-1	C--
W7FJL*	3-1-1	---	W4TP	378-9-1	B-14
			W4DCG	188-8-2	A-13
			W4DGF	4-1-1	A-2
			W4CFR		
<b>Washington</b>			<b>Virginia</b>		
W7TS	13572-52-3	C-89 <sup>20</sup>	W3CHE	48599-97-4	C-51
W7AVL	4704-32-3	B-42	W7FQP	37746-81-3	C-79
W7ETN	4284-28-3	AB-78 <sup>21</sup>	W3BIW	14932-52-2	B-67
W7ANZ	3864-28-3	B-58	W3EXW	12300-50-2	B-60
W7DYY	2448-24-3	--21	W3FGJ	5328-36-4	AC-30
W7FWD*	756-12-1	B-14	W3BEK	3014-29-4	B-41
W7CAB	648-12-1	B-25	W3EBK	3300-25-2	B-25
W7EJG	627-11-3	AB-29	W3EST	3105-23-1	B-24
W7FIM	468-9-1	B-8	W3CSY	2694-23-1	A-60
W7ADU	462-11-2	B-16	W3BSB	1860-20-3	B-49
W7FVZ	240-8-2	B-35	W3RL	798-14-1	A-68
W7EJD	192-8-1	B-6	W3GKB	405-9-1	B-29
W7FYR*	180-6-1	B--	W3FQO	231-7-1	A-10
W7CNM	126-6-1	B-5			
W7FPN	42-3-1	B-20			
W7EYI*	27-3-1	---			
W7KK*	18-2-1	---			
W7BTZ*	8-2-1	---			
W7DJJ*	3-1-1	---			
<b>Pacific Division</b>			<b>West Virginia</b>		
<b>Santa Clara Valley</b>			W8KKG	30099-79-3	C-63
W6CSI	30122-78-3	BC-71	W8AZD	18360-60-2	BC-56
W6LOF	3870-30-2	A-22	W8FVU	10000-48-3	--55
W6KQK	3059-27-3	B-25	W8ASI	4256-32-2	A-25
W6MZH	1680-20-3	A-33	W8LNC	3439-26-1	B-51
W6IWS	1326-17-3	A-19	W8JRL	2996-28-2	BC-28
W6EX	1152-16-2	B-11	W8NCD*	938-14-2	B-44
W6MUR	936-13-1	B-9	W8OXO	414-9-1	B-18
W6CPK	384-8-1	B-44	W8MIP	288-8-1	B-15
W6DL	270-9-1	A--	W8HGA	270-10-1	B-13
<b>East Bay</b>			<b>Rocky Mtn. Division</b>		
W6ITH	14204-53-3	C-69	<b>Colorado</b>		
W6KRM	3584-28-3	B-41	W9PGS	31824-78-3	B-58
W6ASH	2331-21-4	AB-26	W9DNP	6510-35-2	A-25
W6MIJ	1581-17-2	B-20	W9PFU	2583-21-3	A-19
W6MVQ	1496-17-2	B-37	W9PFW*	1024-16-2	A-4
W6LPC	1350-15-2	B-15	W9TWT	784-14-1	B-17
W6ABE	968-14-3	B-29	W9TSQ	36-3-1	A-3
W6CGA	828-12-2	A-18	W9WVF	27-3-3	A-1
W6NGC	108-6-1	--9			
W6ONQ	27-3-1	B-4			
W6AAI	14-2-1	--5			
<b>San Francisco</b>			<b>Utah-Wyoming</b>		
W6RH	22880-65-3	C-71	W7CY	1870-17-3	B-74
W6GPB	21978-66-3	AB-37	W6FRN*	882-14-2	A--
W6CIS	11010-46-4	B-77	W7DES	162-6-2	B-14
W6ODD	8010-40-2	B-35	W6NSV	27-3-2	AB-2
W6JMR	6070-35-2	B-59			
W6MCQ	5548-34-3	B-37			
W6AC*	3588-26-2	AB--			
W6IPH	1748-19-2	B-31			
W6ABB	1170-15-4	A-36			
W6GXV*	135-5-1	---			
W6HFF*	105-5-1	---			
W6ERS	84-4-1	---			
W6HJP	27-3-1	A-2			
<b>Sacramento Valley</b>			<b>SOUTHEASTERN DIVISION</b>		
W6KYO	8360-40-3	--89	<b>Alabama</b>		
W6CBE	2160-24-3	--24	W4ELQ	20223-63-3	B-82
W6IZE	1482-19-2	B-26	W4BEI	12300-50-3	---
W6EMK	594-11-1	B-11	W4APU	5758-38-4	B--
W6EPM	570-10-2	B-11	W4AH	390-10-2	A-18
W6GCM	432-9-2	B-24	W4BOE	120-8-2	B-7
			W4BHY	27-3-1	A-5
<b>San Joaquin Valley</b>			<b>B. Florida</b>		
W6KUT	21255-65-2	C-65	W3BSY	47595-95-4	C-75 <sup>22</sup>
W6MVK	14280-56-4	AC-63	W4BRB	7020-39-3	B-40
W6CQJ	10944-48-4	C-50	W4BWZ	4588-31-3	A-33
W6KEV	9552-48-3	B-58	W4QN	3720-31-3	B-40
W6MEK	6851-31-3	B-66	W4CZS	2756-26-2	B-31
W6ASV	6188-34-3	C-45	W4AGB	2310-22-3	B-17
W6FZA	1632-17-3	A-18	W4DIQ	1911-21-2	A-55
			W4DBF*	1760-20-2	B-49
			W4D00	858-13-2	AB-18
			W4COZ	600-12-1	A-20
			W4C0V	506-11-2	A-13
			W4EEO	410-10-3	A-7
			W4CBW	291-7-1	A-20
			W4BT	240-8-1	A-6
			W4EEM	154-7-1	A--
			W4ATM	72-4-1	B-13
			W4DVO	12-3-1	A-3
			W4EJC	3-1-1	A--

(Continued on page 108)

# KENYON TRANSFORMERS

ARE  
AMATEUR HOUR WINNERS  
*They Never Get the Gong!*



Ask your local Jobber to show you the new Ham line. 180 Different Items: From pre-amplifier to 1 K. W. audio components.

**KENYON TRANSFORMER CO., Inc.**  
840 Barry Street New York, N. Y.  
Export Dept. — 25 Warren St., N. Y. C.

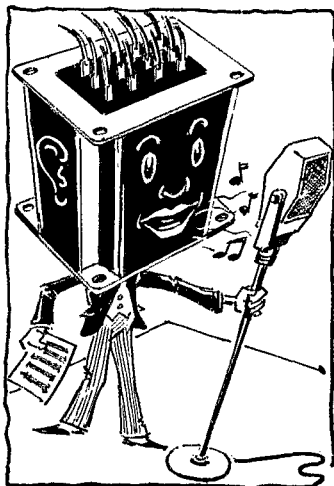

## RADIO ENGINEERING



RCA Institutes offer an intensive course of high standard embracing all phases of Radio. Practical training with modern equipment at New York and Chicago schools. Also specialized courses and Home Study Courses under "No obligation" plan.

Illustrated Catalog on request

**RCA INSTITUTES, INC.** Dept. ST-37

A Radio Corporation of America Service

75 Varick St., New York 1154 Merchandise Mart, Chicago

### 110 VOLTS AC

Anytime! Anywhere! With

**KATOLIGHT PLANTS**

350 Watts AC and 6 Volts DC \$ 89.60

550 Watts AC and 6 Volts DC 220.00

1000 Watts AC and 18-32 Volts DC 294.00

Portable—Self-Cranking

Ask for Special Discount to Amateurs

300 watt 110 v. A.C. Generator only \$19.95

6, 12, 25 and 110 volt Rotary Converters.

AC/DC and DC Generators, etc., etc.

Write for Details

**KATO ENGINEERING COMPANY**

Mankato, Minnesota, U.S.A.

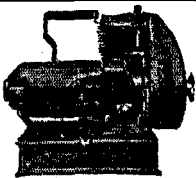

## THE COMPLETE LINE OF TELEGRAPH KEYS

A new and outstanding development — A general purpose type — Moulded Bakelite Base. Figtall connections eliminate insulation problems — No current on bearings — Coin silver contacts. All Metal parts nickel plated.



Type 301 Key

No. 301. Bakelite Key. List Price. \$2.15

No. 301S. With Switch. List Price. \$2.50

No. 302. ¼ inch contacts. List Price. \$2.40

No. 302S. With Switch. List Price. \$2.75

Other models of Hand Keys from \$1.50 to \$3.50 list — Available at leading jobbers everywhere — Write for new literature and Amateur Discounts.

**LES LOGAN CO.**

646 Jessie Street

San Francisco

## DESIGNED FOR THE AMATEUR

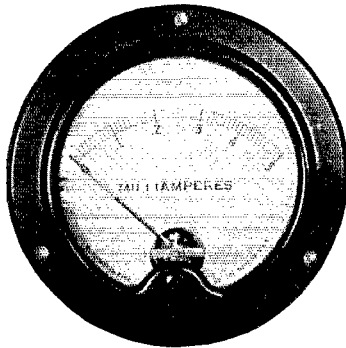

NO. 582

Hoyt Meters are designed and built expressly for the radio amateur. The 582 D.C. shown above is a jewel-bearing, moving-coil instrument of 2% accuracy. The flush bakelite case is 3 1/2" across the flange and fits a standard 2 3/4" panel hole. The companion A.C. meter No. 584 is the same size. Prices are most reasonable.

Ask your jobber for these rugged instruments or send the coupon below for full information

## THE BURTON-ROGERS CO.

Sales Division of the Hoyt Electrical Instrument Works

755 BOYLSTON ST.

BOSTON, MASS.

Gentlemen: Kindly send information about Hoyt Radio Meters.

Name.....

Street.....

City.....State.....

Say You Saw It in QST — It Identifies You and Helps QST

(Continued from page 68)

between the junior op., QSL bureau and rectifier trouble, is pretty busy these days. TV at The Pas is rebuilding with RK23 osc. and pair of parallel RK39's final. XT returned from a trip through Minnesota and Ontario. ABO at The Pas is building a bug for the shack. YR is back at Sherridon using a Sky Buddy Hallicrafter receiver and RK23 osc., RK20 final. At the Flin Flon we have LO who is getting ready for fall activities and LZ takes time out from operating for Arrow Airways to do a little hamming. HM from Edmonton was in Winnipeg renewing acquaintances with AG and RO.

**SASKATCHEWAN**—SCM, Wilfred Skaife, VE4EL—The S.A.R.C. station, AAA, has been working some DX on 14 Mc. BF got a batch of new quartz slabs and MB is handling the grinding job. JB has been transferred by his firm to Yorkton. MA is building a rig for TH using all 6L6's. YX is working on a new outfit, planning T55's in the final. MB reports new doublet brings in DX and cuts down noise level. PQ is increasing power. QZ visited RO, Winnipeg, and brought back an armful of DX cards for the local boys. RJ is working out well on 14 Mc. with flea-power. TW erected new 14-Mc. doublet. UC procured a 212D which will be used to Class A modulate a T-55. CQ is changing around his rig, making it more ship-shape. QZ at Saskatoon is now O.R.S. Holidaying at Carlyle Lake were EL, OC and ES.

Traffic: VE4QZ 4 PQ 3.

#### HUDSON DIVISION

**EASTERN NEW YORK**—SCM Robert E. Haight, W2LU—CC reports 1303 QSO's with VK5HG up to Aug. 16th. A fine record and CC is to be congratulated. JWT is doing fine job as O.O. KJC was heard in Calif. by 6HQJ, RST 589x. FAR gives up 14 for 1.75 Mc. DWQ reports arrival of 2nd Jr. Op. at his shack. KW on 14 Mc. works plenty DX with 8JK's flat top Beam ant. ITR reports BDB, IUR, and HUB at Camp with Natl. Guards. KFB is on 1.75 Mc. C.W. IJT after two years off the air comes back on 56 Mc. JSL enters R.P.I. for Radio Engineering. GZF has A.A.R.S. call WLNC. HNH reports his pupil is now on the air under call of KPFF on 7 Mc. LU is back on 3530 and 3660 kcs. c.w. The boys join in wishing BIA happiness on his new tour of duty as he takes a YF for better or worse. All E.N.Y. hams are reminded that the Schenectady Amateur Radio Assn. Hamfest will be held Oct. 2nd. Don't miss it. Note! All O.R.S. of E.N.Y. On Oct. 15th every O.R.S. who desires to continue to be in good standing must send in a report to the S.C.M.

Traffic: W2CC 15 JWT 11.

**NEW YORK CITY AND LONG ISLAND**—SCM, Ed. L. Baunach, W2AZV—JEB is now O.O. KBG is O.B.S. and VG is O.R.S. JDF is O.P.S. UK joined the ranks of the Benedicts Aug. 9th. CHK is now at BC station WOV. IOP vacationed in Maine. HMJ made W.A.C. HGO received a Public Service certificate for work done during the Ohio River flood. KAM is pulling bugs from his 100 watt rig. APV, located at Haiti, is now HH5PA. PF is handling traffic for VE1IN, relaying it through A.A.R.S. GWQ is at new QTH: 7 Avenue B N.Y.C. JBL's house was struck by lightning. JXJ has been operating portable at Far Rockaway on 56 Mc. FLD is now located at 53 Hale Ave., Brooklyn. LR has been confined in the Brunswick Hospital at Amityville. L.I. IHT is using a Johnson Q for 14 Mc. KJY is using an RME-69, KD has three receivers and transmitters. HNR has been having B.C.L. trouble on 1.75-Mc. 'phone. AZV has been getting out with low power, just as good as high power. JWE is operating on 56 Mc. JVV worked 32 foreign countries. EYS and HHW have been receiving plenty of foreign DX cards. KGN is working ZL's with his '46 final on 7 Mc. The L.I. net will resume activity on 3710 kcs. this fall every night at 8:00 p.m. All those interested should work DBQ, the Key station, on that frequency.

Traffic: W2PF 49 AZV 48 FF 29 JBL 13 HMJ 12 IHT-CHK 7 HGO-CIT 4 HYL 3 JEJ-BYL-FLD 2 DBQ-AA-BGO 1.

**NORTHERN NEW JERSEY**—SCM, Fred C. Read, W2GMN—CIZ has been remodeling for higher power. HAE has been experimenting with 14 Mc. c.w. IOZ is new R.C.C. member. GGW had a two weeks' trip to Nova Scotia with the U.S.N.R. CJX has new reason for burning the midnight oil—an addition to the family. It's a YL. CHH gave up 3.5 in favor of 7 Mc. for the summer. GSI has been working 3.9-Mc. 'phone from Lake Hopatcong. KNQ is having good success with his new rig on 1.7-Mc. 'phone. ISZ is on 14 Mc. c.w. GVZ has worked 89 countries to date; he has new rotary

28-Mc. beam antenna. HZY has moved to new QTH in Bloomfield. JKG is prospective O.R.S. IOP, of the N.Y.C.-L.I. section, would like to get in touch with the N.N.J. section operator who took from him and delivered two messages originating at 3USA. IYG is active on 1.7-Mc. 'phone. Let's get down to business and see how much better we can do during the coming months.

Traffic: GGW 19 CIZ 24 GVZ 4. (June-July: W2DPA 28).

#### ATLANTIC DIVISION

**EASTERN PENNSYLVANIA**—SCM, John Buck Morgan, "Jack," W3QP—Please send reports to 8527 Germantown Avenue, Chestnut Hill, Philadelphia. EZ and CGM are fighting for first place in Main Line Radio Club's Hidden Transmitter Hunts. 3AQN and 8FLA have been giving service to Legionnaires at York. 8EU says full wave ant. no better than the old half wave. 3ETM continues good work in A.A.R.S. Wind storm fractured both masts at 3NF as a form of applause for the safe arrival of a junior op. Congrats, Ed. 3GIQ hung up a fine total by delivering traffic for a local National Guard unit while in camp at Indianthorn Gap. 3CXE boasts a completely renovated station. Thanks for the vote of confidence, OM's. Please help me as S.C.M. to make this Section the "tops." Let me know whenever I can help in any way. 8PCL reports that Haxellon N.C.R. gang had a blowout on Aug. 15th. 3GKF lost his mast and Q antenna in storm. 3GKX is bearing down on the DX.

Traffic: W3EDC 2 EZ 4 DXC 1 QP 194 AQN 4 ETM 31 BGD 6 FAJ 2 EML 4 GLQ 229 BKZ (WLQC 81). W8FLA 98 EU 1 BQ 6.

**MARYLAND-DELAWARE-DISTRICT OF COLUMBIA**—SCM, Edgar L. Hudson, W3BAK—R.M.'s: 3CQS, 3EQU, 3CXL. Chief R.M.: 3BWT. CXL, Capt. Collins, A.A.R.S. went on leave in Canada, Calvin Skaggs on leave in W. Va., Richard Bradley returned from a month's leave in Ark. and is now working WAR, being relieved from duty at WLM when Ed. Day returned. FPQ operated portable at Camp Roosevelt and maintained traffic with EHW, O.R.S. ETE got married. CYV is on the air after four years' absence with a complete new rig from stem to stern. DRE has new LD-2 crystal. EYX has new super Skyriider and is building new transmitter. ASE with FPQ worked portable at the D. of C. Boy Scout Camp. CYO has been vacationing in Pacific Coast States. ER has new QTH and brand new "YL" at his shack. CDQ is vacationing in Europe. DTX has new-14 Mc. 'phone. EZN has new 57-foot mast.

Traffic: W3SN 376 CXL 172 (WLM 960) DQN 164 (WLMC 991) EHW 254 CIZ 210 FPQ 157.

**SOUTHERN NEW JERSEY**—SCM, W. W. Filson, W3BEI—The S.C.M. bewails the loss of three good traffic handling O.R.S. in the persons of DQO, FBM and FTK due to the need of finding employment away from home. I am looking for some new applicants for O.R.S. BEI is busy with Field Day activities. BIR's activities are confined to 56 Mc. Newly installed officers in the Trenton Radio Society: Pres. AWH, Vice-Pres. FBT, Secy. AXU, Treas. GHK. BWR reports activity on 56 Mc. only. FBM reports from N.Y.C. to say that he now has Class A ticket. CZN of Camden spent two weeks at Sea Girt with 114th Inf., Sig. Corps. ZX and a friend from R.C.A. took a vacation cruise to Cuba. To O.R.S. in S.J. area: please send in reports not later than 16th of the month.

Traffic: W3AEJ 8 BEI 2.

**WESTERN NEW YORK**—SCM, Charles F. Smith, W8DSS—R.M.'s: JTT, BJO, CSE, AQE. P.A.M.: CGU. Our two nets swing into action about Oct. first. CSE led the gang this month. NWZ spent the summer on 7 Mc. LUQ will soon be handling traffic on 3.5 Mc. KXA spent a lot of time on 56 Mc. trying to hear the Mt. Washington Expedition. JTT spent his vacation touring eastern U. S. QHX worked Asian VS1AA on 14 Mc. for his W.A.C. CGU spent his vacation roaming around New England and part of Canada. NNJ visited New York City recently looking for a position as broadcast station operator. PLA worked some nice DX on 7 Mc. GWT attended the Hamfest at Marathon. FMH is building a 200-watt 'phone for 3.9 Mc. DRW is a newcomer to Syracuse, having moved there from Sharon, Pa. QDP is developing a very fine bug fist. ABN has a new transmitter which works all bands. BJO will have charge of W.N.Y.-1 again this season. If you have any trouble arranging schedules, just drop a line to any one of the R.M.'s and he will be very glad to assist you. MMV visited HQ's on vacation. 73.

Traffic: W8CSE 7 NWZ 5 LUQ 4 DHU 2.

## WESTERN PENNSYLVANIA SECTION QSO CONTEST

Dates: Starts 6:00 P.M. EST October 29th. Ends midnight.

EST October 31st. Operating hours 6:00 P.M. EST to midnight on Friday and Saturday the 29th and 30th and 2:00 P.M. EST to midnight EST on Sunday the 31st.

Qualifications: Only operators of stations located in the Western Pennsylvania Section of the Atlantic Division (this shall include the boundary counties Potter, Clinton, Centre, Mifflin, Huntingdon and Franklin) who send in copies of their logs with final scores shall be eligible for prizes.

Object: To contact and get acquainted with as many other Western Pennsylvania stations as possible during the contest. Contacts outside the Section do not count in the scoring.

Calling procedure: The following calling procedure shall be used by all stations taking part in the contest: CQ WPA de W8—.

Completion of contact: A contact shall be considered complete when the two operators have "chewed the rag" for at least ten minutes.

Scoring: One point shall be allowed for each contact with a different Western Pennsylvania station. Each station can only be worked once.

Note.—It is not necessary that the station you work turn in a score. All that is required is that the station be in the Western Pennsylvania Section.

Power: Power used will have no effect on the scoring.

Frequency: Any or all frequencies may be used. Either or both c.w. and 'phone can be used.

Log sheets: Copies of the log sheets, listing the station worked, the date, the time contacted, time contact completed (at least ten minutes) and the location of the station worked, shall reach the S.C.M. (Kendall Speer, Jr., W8OFO, Lowber, Pa.) not later than midnight, November 20th.

Prizes: There will be plenty of prizes to make things interesting. Besides prizes for high scoring, there will be three or four prizes drawn from a hat for those who fail to win in the high scoring. Even if you only contact one station you have a chance of winning a prize. Last year over sixty dollars worth of prizes were awarded. DON'T FAIL TO TAKE PART AND SUBMIT A LOG.

Jamestown, N. Y. QNW has a new 400-watt 'phone on 1.75 Mc. GQE has to rebuild his exciter to secure enough excitation for his 838's. BID is increasing power to 200 watts. QCI, the State Teachers College at California, Pa., will operate all c.w. bands with 400 watts and 1.75-Mc. 'phone. EUM is rebuilding with a kw. 1.75-Mc. 'phone. OAJ is using a pair of T20's on 56 Mc. QHS worked an OK on 14 Mc. BVP got married. IYQ is completing a new oscilloscope. MWV moved to Farrell. Ten members of the Valley Key and Mike Club attended the S.H.B.P. & M. Hamfest. AOE is an N.C.R. prospect. New Ham: Fayette City, RBN. Traffic: W8PFW 45 OFO 30 NDE 12 KOB-KUN 6 IOH 3 GBC 2.

## ROANOKE DIVISION

**NORTH CAROLINA**—SCM, H. S. Carter, W4OG—  
Ex-W4CJP now in the U.S. Marine Corps, has been seeing service aboard the U.S.S. *Ranger* in the Pacific; has the call 6OZM. The Salisbury Amateur Radio Club will have the November meeting of the Floating Club. EAM has a new Breting-14. DOU is active on 14 Mc. EAA is on 7 Mc. about half of the time. CEI spent his vacation at the Beach. DOZ has a new "bottle" in the final. DOQ has his new home-built receiver going FB. The Gang had a steak supper at DOV's cabin for 3CBG, who is visiting in the city. EMV is changing his rig from bread board to rack and panel style. EIT has a 6L6 Oscillator, and a 2-tube home built receiver. DZS has been rebuilding. DGU burned out power supply. BHR is working on his new 600-watt 'phone; he will use 100th's final. DCG is getting out swell with T55 final. ESO entered the low power contest using 7-Mc. band. ESB is rebuilding for 1.75-Mc. 'phone. CEI is sticking to 3.9 Mc. ESO visited DRU. FT is plugging away on 28 Mc. NY is getting a rig on the air before his license expires. BRK recently underwent an operation, but he has been removed to his home now. Hurry up and get well. Sweeney, CYB had as visitors this month 8MLM and 8QDP from Oneida, N. Y., 8NGD and sister Edith and 4BV. DSO is planning a new exciter unit and more power for a 28-Mc. 'phone rig. AAU is in Texas busting Broncos, and digging oil wells. DWB is working portable in Virginia. DGV is now O.P.S. BYA is now P.A.M. Give him your support, fellows. CFR, BOH and ABT and their families and friends spent a week at Farmers Fishing Camp near Sparta. They had as visitors RA, BFV, 1KKR and OG over the week-end. DVU has a swell kw. power supply. 73.

Traffic: W4NC 15 DZS 8 DCG-ABT 3.  
**VIRGINIA**—SCM, Charles W. Waff, Jr., W3UVA—  
GPC wants traffic schedules. FBL has been having plenty of fun on 56 Mc. with a mobile unit. GJP is putting in a pair of T-20's. AIJ visited FGJ and CHE. AHQ has moved to Staunton. FMY and AIJ have new 808's. GBC visited a bunch of hams when he returned for a visit to his old home at York, Penna. BSY is traveling in Europe. EZL has moved back to his old home, Charlottesville. UVA is still rebuilding.

Traffic: W8GPC 3.  
**WEST VIRGINIA**—SCM, Dr. Wm. H. Riheldaffer, W8KKG—  
The Logan amateurs have a club going. The Black Diamond Radio Club. Q/QZ applied for ORS. KYJ has a new transmitter going. OLV has been holding down 7228 kc. all summer. QBS joined C.C.C. OFD burned out power transformer. MIS and NTV attended South Hills hamfest. MIT moved to Parkersburg. 3FCM moved into the section. LCN schedules K5AG twice weekly. KLP and 9CEE are operating in the section. The Charleston Gang piled up 1500 points in the Field Day activities. The Charleston Club has elected CZ pres. RDE (XYL) vice-pres., PUA secy.-treas. (RDE is Mrs. PUA). BKI, CZ, LII, PUA, HI and OBA are working 56 Mc. IRN is putting up a transposed beam for 14 Mc. JRL has 106 countries and called up KKG to spot him HZ5NI, whom they both worked bang, just like that. Director Caveness visited the A.R.R.L. affiliated clubs over the state and gave many of the gang a chance to meet him for the first time. Mrs. Caveness accompanied him on his trip that included stops at Bluefield, Charleston, Huntington, Clarksburg, and Wheeling.

Traffic: W8HD 3 MOP 1 KKG 57.

## NEW ENGLAND DIVISION

**CONNECTICUT**—SCM, Frederick Ellis, Jr., W1CTI—  
KFN has new rig with pair of HF100's final. JMY is looking forward to opening of the Nutmeg Net. ES has a fine schedule with VE1IN. UE moved to Granby. ITI is warming up for traffic season. INP built and installed an

(Continued on page 104)

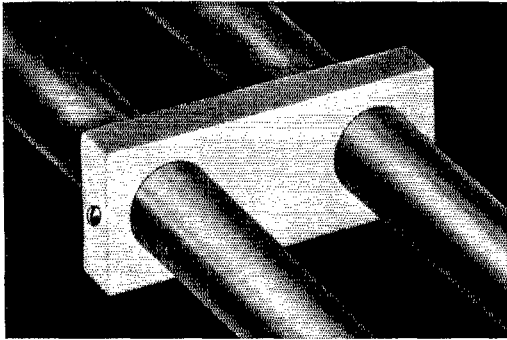

## Q-BAR INSULATOR

National offers a new Isolantite insulator for a fixed-ratio Q-bar transformer to match a center-fed half-wave antenna to a feeder using No. 12 B & S wire and six-inch spreaders (72 ohms to 600 ohms). They are designed for use with rigid duralumin tubing with an outside diameter of 3/4 inches, and are simply slipped over the tubes. The complete assembly is rigid, efficient and tidy as well as convenient to handle.

Q-Bar Insulator, Type QB, Net Price . . . . . \$ 21

**NATIONAL COMPANY, INC.**  
MALDEN, MASS.

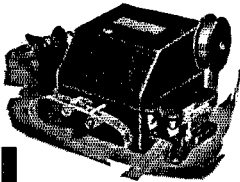

## At Last! A Perfected AUTOMATIC SENDER

Save your fist. Let the Automatic Sender raise your stations for you. Repeats calls or messages indefinitely. Length of messages unlimited. Sends from 2 to 70 words a minute. Motor driven. Entirely automatic. Built-in tape perforator. Absolute uniformity in spacing of characters. Used with buzzer or oscillator, makes excellent code teacher for novice and speed-builder for the advanced amateur. Complete with 4 rolls of tape and full instructions. No extra equipment needed. If your dealer can't supply you, write us.

only  
**\$12.50**

Postpaid  
in U. S. A.  
Patent  
Pending

**Gardiner-Levering Co.** Haddon Heights, New Jersey, U. S. A.

# LEARN RADIO

— TELEVISION —

New Beginners' Class Sept. 13th. Send for 48-page catalogue, explains fully, 500 licensed graduates placed in last six years in broadcasting, shipping, police radio, aviation, etc. Oldest, largest and best equipped school in N. E. We each all branches of radio. Tel. HAN. 8184.

Ten operators placed with Pan-American Airways in one week.

Radio Service Instructions Given

Open All Summer

**MASS. RADIO SCHOOL**

18 Boylston Street, Boston

(Continued from page 98)

### W. Florida

W4CDE 19406-62-3- B-63  
W4CRA 1596-19-1- C--

### Georgia

W4CBY 89838-138-4- C-84  
W4YC 20060-59-2- C-88<sup>4</sup>  
W4VX 930-15-2- A--

### SOUTHWESTERN DIVISION

#### Los Angeles

W6CXW 110544-139-4- C-88  
W6GRL 90750-125-4- C-90  
W6FZL 72189-117-4-BC-88  
W6JBO 69300-110-3- C-89  
W6GRX 64746-109-5- B-87  
W6KIP 35014-82-3- C-84  
W6AM 14178-51-3- C-70  
W6GHD 11550-50-3- B-47  
W6IRD 10428-44-3- B-55  
W6JJU 7128-36-1- C-82  
W6KNF 5742-33-2-BC-43  
W6JWL 5610-34-2- B-29  
W6FKZ 2756-26-2- C-12  
W6IOX 2160-20-3- B-81  
W6AX 2046-22-2- C-23  
W6FAD 1296-18-4- A-27<sup>8</sup>  
W6MNA 1190-17-3- A-20  
W6GM 966-14-1- B-20  
W6DVT 612-12-3- B-22  
W6IDLW 720-12-3- A--  
W6NLLZ 517-11-2-AB-6  
W6BSV 486-9-2- B-9  
W6DIO 462-11-2- B-9  
W6HG 420-10-2- A-36  
W6AGL\* 180-6-2- ---  
W6AAE\* 120-5-1- A-11  
W6LFC 75-5-1- A-4  
W6CPG 48-4-1- B-13

#### Arizona

W6FZQ 12150-50-4- B-45  
W6KFC 1800-20-4- A-26  
W6AUI 6-1-1- ---<sup>8</sup>

#### San Diego

W6GCX 39093-83-3- C-64  
W6BAM 26352-72-3-BC-73  
W6KBD 14630-55-3- B-83  
W6GCT 5016-29-1- C-45  
W6BBR 2886-26-3-AB-52  
W6BVX 2346-23-3- B-57  
W6JQX 798-14-3- A-13  
W6OLI\* 495-11-1-AB--  
W6GTM 378-9-2- A-20  
W6AXC 243-9-3-AB-7  
W6IBG 96-4-1- B-16  
W6LJ\* 48-4-1- ---

### WEST GULF DIVISION

#### N. Texas

W5DM 21056-64-3- B-48  
W5AMO 9648-48-3- B-53  
W5YF 9240-44-3- B-32<sup>7</sup>  
W5EKK\* 5832-36-2- B-50  
W5DXA 4050-30-3- B-22  
W5AQS 2580-20-2- B-40  
W5CPT 1170-15-2- A-23  
W5BNQ 960-16-1- B-22  
W5FTX 585-13-2- B-33  
W5EUP 264-8-2- A-77  
W5BSY 243-9-3- A-5  
W5BAM\* 24-3-1- ---  
W5EOE 18-2-1- B-4  
W5DWT\* 6-1-1- ---  
W5EOW\* 3-1-1- A-5  
W5FBQ 3-1-1- ---

#### Oklahoma

W5YJ 10780-44-1- C-55<sup>8</sup>  
W5FLU 2289-21-3- B-70  
W5ACD 1782-18-1- B-46  
W5FFW 270-9-2-AB--

#### So. Texas

W5VV 29032-76-3- B-81  
W5JC 24990-70-3- C-65  
W5FI 14750-50-3- --47  
W5EXR 1200-20-1- B-22  
W5FZD 741-13-3- A-38  
W5EIS 648-12-1- A-38  
W5FNA 360-9-2- B-19  
W5DBN 350-10-1- B-27  
W5ARO 264-8-2- A-22  
W5FTU 252-7-1- A-5  
W5DAW 144-6-2- A-12

### CANADA

#### Maritime

VE1EA 28543-73-5-AB-77  
VE1EO 540-10-1- A-12  
VE1EV\* 27-3-1- ---  
VE1GS\* 12-2-1- ---

#### Ontario

VE3WA 39605-89-3-BC-80  
VE3KF 26554-71-4- B-73  
VE3AQ 9030-42-2- A-54  
VE3ER 3694-42-3- B-51  
VE3OI 4030-30-2- A-49  
VE3MY 2400-25-3- B-51  
VE3ES 1656-18-2- A-29  
VE3GH 1368-19-3- A-32  
VE3GT 1296-16-3- A-41  
VE3DA\* 1008-16-2- --25  
VE3EA 986-17-3- B-37  
VE3JT 945-15-1- B-16  
VE3DU 561-11-1- A-22  
VE3AAP 380-10-1- A-36  
VE3KQ 330-10-1- B-11  
VE3VC\* 216-8-1- B-10  
VE3AJE\* 147-7-1- A--  
VE3VN\* 90-5-1- B-20  
VE3WH\* 10-2-1- ---

#### Quebec

VE2AX 56341-103-4- B-81  
VE2CR 3591-27-1- B-34  
VE2BV 3483-27-2- A-58  
VE2DF 3276-26-3- A-54  
VE2GX\* 812-14-1- --23  
VE2DO 594-11-2- --12  
VE2KA 528-12-2- A-19  
VE2GO 432-9-1- A-8  
VE2JD 396-11-1- B-21  
VE2MW 271-9-1- B-14  
VE2DQ 147-7-1- B-11

#### Alberta

VE4PH 9940-45-2- A-44  
VE4EA 2904-24-1- B-56  
VE4RU 966-14-2- A-27  
VE4ABH 612-12-3- A-51  
VE4HM 344-8-2- A-9  
VE4GD 162-6-2- A-10  
VE4FT 96-4-1- A-17

#### British Columbia

VE5QP 6965-35-4-AB-71  
VE5BI 5611-31-3- B-42  
VE5FG 1728-18-2- B-43  
VE5MZ 1079-21-2- B-47  
VE5QA 715-13-2- A-19  
VE5VO 590-10-2- B-24  
VE5AC 506-11-3- A-27  
VE5OA 450-10-1- A-7  
VE5AJ 329-7-2- A--<sup>8</sup>

#### Manitoba

VE4RO 9440-40-1- C-40  
VE4DU 6300-36-3- B-31  
VE4MJ\* 422-12-1- B-16  
VE4TO\* 240-8-1- ---  
VE4OB\* 108-4-1- ---

#### Saskatchewan

VE4JV 3224-26-2- B-33  
VE4CV 1350-18-2- B-51  
VE4OQ 189-7-1- A-9  
VE4QZ 105-5-1- A-6

### AFRICA

#### Algeria-FA

FA8RY 45-3-1- ---

#### Egypt-SU

SU1SG 43260-30-4- B-77  
SU1CH 11220-15-3- B-39

#### Mauritius-VQ

VQ8AF 2500-10-1- A--

#### Southern Rhodesia-ZE

ZELB 714-7- -- ---

#### Tunisia-FT

FT4AK 4710-15-2- --30<sup>8</sup>

#### U. of So. Africa-ZS/ZT/ZU

ZU6P 34688-32-3- A-85  
ZS2A\* 57240-36-3- A-67  
ZS5U 6928-16-2- A-44  
ZS1AH 5710-10-1- A-42  
ZS1Z 4004-11-1- A--  
ZT5Z 1280-9-1- A-7

(Continued on page 106)





# Here's the answer

## to 5-METER CRYSTAL CONTROL

The new Bliley HF2 10-meter crystal unit now makes possible high stability 5-meter transmitters of greatly simplified construction. Possessing a high activity, these crystal units can be used in conventional circuits with certain standard low-priced tubes for single tube low power or multi-tube high power 5-meter transmitters.

It is now an established fact that better 5-meter contacts are possible with the stability and concentration of carrier power brought about by the use of crystal control. For improved results, use a Bliley HF2 10-meter crystal unit—priced at \$5.75. Technical data and constructional information is given in Engineering Bulletin E-5, available from your distributor. Bliley Electric Company, Erie, Pa.

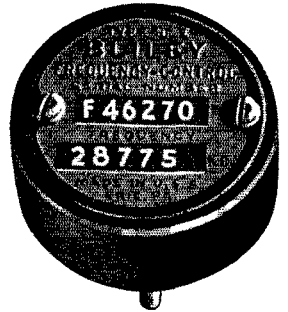

# BLILEY HF-2 CRYSTAL UNIT



## THE CANDLER SYSTEM

FOR 25 YEARS THE SHORT-CUT TO PROFESSIONAL SPEED AND ACCURACY

NOW IMPROVED 50%

Candler has done it again! Twenty-five years ago his Automatic Sound Sense principle was heralded as the "World's greatest contribution to human efficiency in the art of telegraphy." And now, after training thousands of operators, just like yourself, for the finest jobs in radio telegraphy — Candler's genius has evolved even quicker methods of developing automatic sound consciousness.

From personal contact with every student, Candler has discovered the stumbling blocks to code skill. He can save you months of laborious practice. You have the most amazing opportunity that has ever been offered in all code history! Already much faster than most methods, Candler training will now make you a top-notch operator in *less than half* the usual time! You will send and receive code like you read and talk — without strain or conscious effort. You'll breeze right through that exam, and be ready to take your place alongside the other Candler trained experts.

Don't go on just wishing you had Candler training when it is so easy and inexpensive to get. *Today* can be the turning point in your radio career — if you mail the coupon below. Why delay? *Mail it now!*

**CANDLER SYSTEM CO.**  
Dept. Q-10, ASHEVILLE, N. CAROLINA, U. S. A.

**MAIL COUPON TODAY FOR FREE BOOK**

CANDLER SYSTEM CO.  
Dept. Q-10, Asheville, N. Carolina, U.S.A.  
Send me your FREE book right away! My present speed is.....wpm.  
Name.....  
Address.....  
City.....State.....QST—3-10 A

(Continued from page 101)

overload relay to protect his RK-20. HXZ has been getting rdy ready for Nutmeg Net and N.C.R. operations. IMV has been on 14 Mc. most of the time. BIH found time to do some low power DX work. JLL is on 14 Mc. for DX. HYF had 2½ hour QSO with 2GQX. BDI is busy on new W1AW details. CTI is writing this report in Burlington, Vt. on a two weeks vacation. See you all in Bridgeport at the State Convention.

Traffic: W1KFN 43 JXP 34 JMY 33 ES 31 UE 25 ITI-1NP 9 HXZ 2 IMV 1 HYF 3.

MAINE—SCM, Winfield A. Ramsdell, W1FBJ—APX, formerly of Rangeley, is now 9AAA operating from Springfield, Mo. Look for him on 7142 kcs. KRZ is new ham in Brocklin. BYP is building 56 Mc. job to take along in his car during vacation. DOB is yachting but gets on the air from IWY while in New London. KNB is coming out soon with new rig on 3.9-Mc. 'phone and expects to run about 800 watts. KNJ is active on 1.75 Mc. ETY has fine new outfit all set to go on 3.5 Mc. The P.A.W.A. plans to resume activities the first of Oct. HZJ is looking for schedules on 3.5 Mc. AML claims W.A.S., using 70 watts on 3.5 Mc. and 275 watts on 14 and 7 Mc. EUL is dividing time between 14-Mc. c.w. and 1.75-Mc. 'phone. JJN held hourly contacts with VE1IN while the plane, which was going to Kent's Island to do some aerial mapping, was held up at Rockland due to weather conditions. KMM is using a pair of '10's in the final on 3709 kcs. AUC has taken his outfit to camp for the summer and is operating 14-Mc. c.w. DHD is also using this band. JVU is keeping things hot on 1.75-Mc. 'phone. ATS is working 7 Mc. with 125 watts, 3.9-Mc. 'phone 70 watts and has heard COO on 56 Mc. from Mt. Cadillac, worked CBU, Stockton, CRU, Searsport. FA is experimenting with 56-Mc. receivers. KJK is getting new 1938 Skyryder receiver. GKU has accepted a position in Fort Fairfield. BXH has obtained commercial ticket and will operate on private yacht. JRS went ham visiting during his vacation. JOC has portable mobile rig in car and has been able to contact the 8th district consistently on 14-Mc. 'phone running 25 watts input. INW has new HF-100 final.

Traffic: W1FBJ 124 INW 40 GOJ 29 EUL 10 TE 2 (June-July; W1ERO 7).

EASTERN MASSACHUSETTS—SCM, Albert N. Giddis, W1ABG—IHI takes the lead away from AKS. KH visited VO3R, 3X, 3P and 4Y on trip. IIN is using RK34 on 56 Mc. JTM paid the S.C.M. a visit. HKY finally worked Y1ZBA. RE is secretly practicing on a "bug"! IWC received card from U9MF for W.A.C. KMS and KKO send in very interesting first reports. AKS has taken AGX, AMT, JNF and HWE with him up on 7 Mc. Well, gang, it's been a great summer for inactivity! Let's get those rigs tuned up and dig in NOW to keep Eastern Mass. ahead of the pack. 73.

Traffic: W1IHI 192 AKS 112 (WLGO 140) INA 109 KH 102 EMG 62 AGX 51 AMT 38 HWE 24 HXE 19 IIN 16 JCK 12 JNF 12 (WLG 38) JTM 9 HKY 8 KMS 4 RE 2.

WESTERN MASSACHUSETTS—SCM, William J. Barrett, W1JAH—Well, fellers, the total traffic reported for the entire Section this month amounts to about three good schedules. It's about time we realized that as far as organized communications activities are concerned we are dead. Since a similar condition exists in our A.A.R.S. net it looks as though we just haven't got what it takes, or else we just don't give a hoot. Any disaster that is likely to affect New England is almost certain to center in the Conn. Valley, right in our own front yard, yet we not only lag behind the others in emergency preparations, but show mere apathy towards any notion of putting our shoulder to the wheel. Past requests in this space for volunteers for emergency nets, or even for suggestions for such nets have gone totally unheard, or at least unheeded. Our record shows us up as the worst Section in the Division. This appeal now is addressed to each and every ham in Western Massachusetts, whether you have had your ticket twenty years or twenty minutes. 3FXZ/1 schedules K6NXD daily and reports signals very good here in N.E. IOT takes a shot at 14 Mc. and works a few furriners. IOR has new exciter perking. Chet reports IOC/KAW in new QTH. AJ is still working them on 7 Mc. BVR returns from summer school, and finds the old home skywire better than the haywire one at school; Perce has new UEEX-10. JAH is working 'phone and c.w. on 3.5 and 1.7-Mc. bands, so if any of you guys want a schedule to discuss section matters just name your frequency and time. IZW is playing with 1.75 Mc. COI reports signals weaker

than last year in D.J.D.C. contest. KRP is new ham in North Adams. BKG is building s.s. super. HNE, AZW, JAH, FNY and BKG with the YL's and YF's had swell time at picnic. Fellows, how about some action?

Traffic: W3FXZ/1 23 W1IOT 23 IOR 22 AJ 8 BKG 6 JAH 12.

NEW HAMPSHIRE—SCM, Carl B. Evans, W1BFT—The New Hampshire Emergency Network (N.H.E.N.) fall drills will start Sept. 19th and continue from then every first and third Sunday of each month thru the coming season. The 3840 net will drill at 11:00 a.m. Your S.C.M. is trying to cover the state with a traffic net of some sort using the 3840 emergency net as a base. Every one the least bit interested, please get in touch with the S.C.M. immediately, and many thanks. ANS and APK have renewed their O.P.S. KIN boosted his input to 100 watts to a pair of 6L6G's in parallel. CEA has been on 56 Mc. this summer dodging QRN. 8IPD/1 operated from the summit of Mount Washington for a week using an RK34 on 56 Mc. and did a nice job in covering Northern New England. The M.V.A.R.A. conducted a general intelligence test on club members with a crystal as a prize. JCA won with a mark of 70.0!!! JBA is looking for some one to play checkers with him on 56 Mc. JDP has moved to the new QTH and put up a 60-foot mast for 56-Mc. operation. BFT/1 made 67 contacts from Pack Monadnock one evening on 56 Mc. using a portable-mobile RK34-6L6G transmitter and the two matched impedance antennas of KPL's on the mountain top.

Traffic: W1KIN 9 BFT 5 HG 3.

RHODE ISLAND—SCM, Clayton C. Gordon, W1HRZ—JLM writes that HEN is some place in Europe after taking a summer cruise with the N.C.R. and that ex-JPJ is in Canada. IZO hits a bit of 56- and 3.9-Mc. 'phone. 2JDE has been guesting in Newport for the summer. JNO is working low powered 14-Mc. 'phone and needs only Asia for W.A.C. 'phone and c.w. HJ was on C.G. Argo during International Cup Races. BVI is working some DX on 56 Mc. EAO recommends DQ for O.P.S. GTN is warming up the A.A.R.S. net for fall.

Traffic: W1ETD 2.

VERMONT—SCM, Alvin H. Battison, W1GNF—BJP visited AAK, AHN, GNF, JRU and KJG. CGV and EKV are on 56 Mc. TJ visited Niagara Falls. DPO is organizing a 'phone net on 1.9 Mc. AVP and BNS are hospital patients. KJG built a lattice mast, which the wind storm promptly crushed. IRO is leaving for New York and then for South America. BD went to Georgia for his vacation. EZZ purchased a building; the future home of his "shack"! BCK, BD, ERJ, FPS, HOW and KOO spent two weeks encampment with the National Guard at Fort Ethan Allen. KIE is our latest c.w. enthusiast. The Lamaille Valley Club now boasts seven members and is planning to affiliate with the A.R.R.L. KPH, a new amateur in Barton, reports the construction of a 70-foot wooden tower. KOO is a new amateur in Orleans. DQK is now working on 14 and 28 Mc. The Twin State Radio Club of White River is reorganizing and has moved clubhouse to North Hartland. AD is operating on 7 Mc. from WNBX. Plans for fall operation are taking shape nicely. Comments and suggestions from all of you fellows will be greatly appreciated. C.R.M., FSV, would appreciate a card from any station desiring Vt. schedules this coming season, either for traffic or for W.A.S. contacts. An enthusiastic group of Vermont amateurs assembled at the Copley Country Club, Morrisville, Aug. 21st for the State Hamfest. Messrs. Battey and Handy from A.R.R.L. Hq. put in a much appreciated attendance, and gave interesting information on the current problems of our hobby. "Cliff" Parker and "Bing" Day of the Lamaille Valley Net, sponsors of the Hamfest, managed the program. Swimming and golf was enjoyed during the afternoon. Prizes were awarded as follows: Tallest Story, IDM; Heaviest, UE; Lightest, IRO; Tallest, FSV; Best "Mike" Voice, JRU; Door Prize, FSV; Door Prize for S.W.L.'s, Channing Mould; QSL Card Contest, KIE, CBW and IDM. "Ed" Handy's "first recorder" proved a popular attraction; first prize for sending went to GAE and second to FSV. "Ev" Battey gave a fine demonstration of high speed straight key sending. Those present were AHN, BDI, CBW, DPO, FGO, FSV, FSW, GAE, GAN, GNF, IDM, IQG, IRO, JLF, JRU, KIE, KJG, KNC, UE, Channing Mould, Merwin B. Forbes, several YF's, YL's and interested people. Several of the fellows took candid photos of the group. AHN took 16 m.m. movies of the whole gang.

Traffic: W1FSV 5 AVP-EZ 4 GNF 2 AHN 1.

## Omission from Circuit Equalizing Article

A most unfortunate error occurred in the publication last month of Mr. Gluck's article, "Circuit Equalizing to Improve Receiver Performance." A portion of the text and two illustrations were omitted. We greatly regret the omission. Here's what was left out—it should have followed page 31, Sept. QST.—EDITOR.

If we now adjust or calculate the value of  $C_T$  for the 1st r.f. and mixer so that all circuits will be resonant to 2252 kc., these values will then be:

	$L$	$C_T$	$C$	$f$
1st r.f.....	110	15.5	30.0	2252
(B) 2nd r.f.....	100	20.0	30.0	2252
Mixer.....	90	25.5	30.0	2252

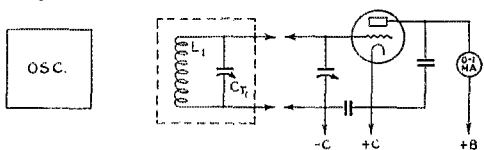

FIG. 2—A SIMPLE VACUUM-TUBE VOLTMETER IS USED IN CONJUNCTION WITH THE OSCILLATOR FOR CHECKING INDUCTANCES

The bypasses are not critical—0.01- $\mu$ fd. condensers will do.

So far so good. The three circuits are each resonant to 2252 kc. Let us now vary  $C$  until it

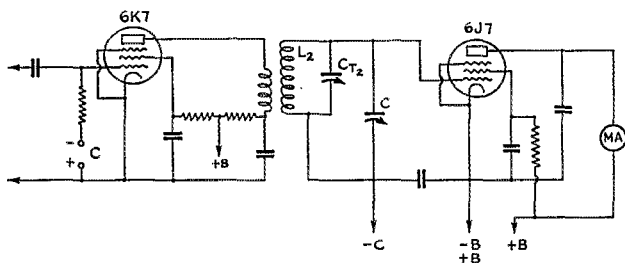

FIG. 3—PRACTICAL OPERATING CONDITIONS ARE SIMULATED IN THIS SET-UP

The effect of the previous stage and the primary winding are compensated for by the use of a "dummy" r.f. stage. Condensers and resistors have the usual values for the circuits under consideration.

is equal, first to 100  $\mu$ fd., then to 170  $\mu$ fd. and see if the three circuits will still be on "talking terms."

	$L$	$C_T$	$C$	$f$
1st r.f.....	110	15.5	100.0	1414
(C) 2nd r.f.....	100	20.0	100.0	1455
Mixer.....	90	25.5	100.0	1512

	$L$	$C_T$	$C$	$f$
1st r.f.....	110	15.5	170.0	1118
(D) 2nd r.f.....	100	20.0	170.0	1157
Mixer.....	90	25.5	170.0	1202

Tables (C) and (D) show each change in the resonant frequency resulting from a variation in

C. In (B) all circuits were resonant, but in (C) and (D) conditions have changed. Such variations in frequency cannot be tolerated in a good receiver.

For perfect tracking of the three circuits, the following conditions must be religiously observed:

1.  $L_1 = L_2 = L_3$ .
2.  $C_{T1} = C_{T2} = C_{T3}$ .
3. The capacity of each section of the ganged condenser at any setting must be equal to that of each of the remaining sections at the same setting.

### CHECKING CONDENSER SECTIONS

We shall now proceed to check our ganged condenser. For this work an oscillator or a regenerative receiver will be needed. It need not be calibrated. The circuit arrangement is shown in Fig. 1.

Apply all voltages to the oscillator and set the receiver and its b.f.o. into operation.

1. Set the gang condenser at about 5° (minimum capacity).
2. Turn condenser  $C$  on the oscillator and adjust it for zero beat as indicated by the receiver. Do not disturb the receiver setting.
3. Connect test leads to section No. 2 and turn condenser  $C$  until zero beat is again indicated.

4. Repeat the above for sections Nos. 3 and 4 and note what the reading of  $C$  was for each of the sections when zero beat was indicated.

If the four readings of  $C$  are identical, then we may feel certain that the four sections of the ganged condenser have identical values of capacity at 5°. Slight variations from this desired condition may be overcome or corrected by bending the radially slotted end plate on each section.

The procedure is repeated with settings of the ganged condenser at 20°, 35°, 50°, 65°, 80°, and 95°. With the corrections completed, the condenser problem is solved and we may now confine our attention to the inductances.

### EQUALIZING INDUCTANCES

So that the work may be done correctly, it is important to remember that the coils should be mounted in their shields with covers in place. If possible do not place padding condensers inside of coils. These have an effect on inductance as well as on the resistance of the coil. Since pruning of the coils is to correct for the effects of the shield, etc., this precaution must not be taken too lightly.

## Type HFM Portable Crystal Control

7000 — 60,000 Kc.

PHONE — CW — MCW

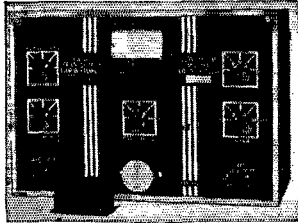

- Single 40 Meter Crystal for All Bands
- A.C. or Battery Operation
- Complete With Coils for 5-10-20 and 40 Meters

H-F-M  
TRANSMITTER  
**\$57.60**

## 5 METER DUPLEX TRANSMITTER-RECEIVER

- T.R.F. and Super-Regeneration
- 7 Tubes — 5" Dyn. Speaker
- 6E6 Unity Coupled
- 10 watt Carrier
- 100% Modulation
- Duplex Operation — PHONE — MCW

TRANSMITTER —  
RECEIVER

**\$47.70**

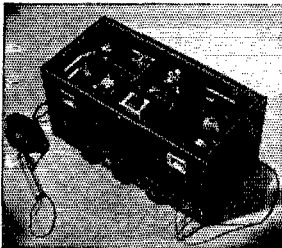

**RADIO TRANSCIVER LABORATORIES**

8627 — 115 Street, Richmond Hill, New York

## RADIO COURSES

RADIO OPERATING: Prepare for Gov't License Exam. ●  
RADIO SERVICING: including Short Wave ● AMATEUR  
CODE ● ELECTRONICS ● TELEVISION ●

Day and Evening classes — Booklet upon request

**NEW YORK YMCA SCHOOLS**

4 West 63rd Street, New York City

## Press Lever — SEMI-AUTOMATIC KEY DOES THE REST

IMPROVES  
SENDING

Genuine Martin

# VIBROPLEX

Semi-Automatic Key

Cuts  
Effort  
in Half

**JUNIOR  
ONLY  
\$12.50.**

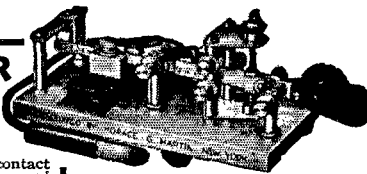

Small and more compact. Large contact points. Black japanned base. A low priced key with world famous Vibroplex Quality. Other models, \$17 and \$19.

Every code sender wants to be a GOOD, CLEAR, FAST sender — YOU can be with a New Genuine Martin Vibroplex semi-automatic key. Over 100,000 operators have found sending with a Vibroplex the easiest, fastest and best way to send. Faster than the fastest hand sender — less than half the effort. Easy to learn. Easy to use. Easy to own. Order to-day! Insist on the Genuine Martin Vibroplex key. Accept no substitute. Your old Vibroplex accepted as part payment. Money order or registered mail. Write for FREE illustrated catalog.

Free  
Illustrated  
Catalog

**THE VIBROPLEX CO.**

832 Broadway

New York, N. Y.

106

Say You Saw It in QST — It Identifies You and Helps QST

(Continued from page 10E)

ZT5P 720 6-1 A-9  
ZS4U 180- 4-1 A-7

### ASIA

#### China—XU

XU8HW 5760 12-2 B-40  
XU8JR 2160 10-2 A-33  
XU8IS 1005 5-2 A-22  
XU8XQ 495 3-1 B-14  
XU8CB 430 5-1 A-24  
XU8HR 111 3-1 A-8

#### Hong Kong—VSS

VS6AH 240 5-3 A- --

#### Japan—J

J4CT 8352 18-3 --56  
J2LK 7340 20-3 A-25  
J2MH 5265 15-2 --11  
J3FI 752 8-2 --16  
J2IX 616 4-1 --15  
J2NX 144 3-1 A-16

#### Chosen (Korea)—J8

J8CA 3066 14-2 A-18

#### Manchukuo

MX2B 936 8-2 --3

#### Madagascar—FBS

FBSAE 1638 9-1 B-16

#### Soviet Union (Siberia)—U9

U9AW 1782 9-1 A- --

#### Straits Settlements—VSI

VSIAB 510 6-2 A-4

### EUROPE

#### Austria—OE

OE3AH 71552 43-4 A-87  
OE7EJ 47005 35-3 A-76  
OE1ER 40982 31-3 A-88  
OE6AX 4777 17-2 A-32  
OE1EK 2568 12-3 A-38  
OE7JH 1824 19-4 A-16  
OE1CM 806 13-3 B-11  
OE5JB 504 9-2 A-5  
OE1JZ 180 6-1 A-5  
OE1EZ 60 4-1 A-1  
OE1FP 45 3-1 A-2  
OE6OB 36 3-1 A-12

#### Belgium—ON

ON4FE 29915 31-3 AB-60  
ON4IF 13608 21-3 A-49  
ON4DS\* 10764 23-4 A-44  
ON4GK 7590 22-3 A-31  
ON4HC 4700 20-3 A-26  
ON4CD 3648 12-2 A-26  
ON4DX 3330 10-1 B-17  
ON4AW 2090 10-1 A-26  
ON4NRA 1800 8-1 B-19  
ON4MS 1260 10-1 A-23  
ON4GU 720 6-1 A-1  
ON4CC\* 124 4-1 A-1  
ON4LX 48 4-1 A-1  
ON4EF 30 2-1 A-4

#### Czechoslovakia—OK

OK2HX 41180 29-3 A-77  
OK2LO 36053 31-3 A-65  
OK2MV 9072 18-2 A-54  
OK1MB 5528 12-1 A-34  
OK1CX 4950 22-3 A-43  
OK1AB 2882 22-3 A-25  
OK2MM 1034 11-2 A-7  
OK1ZB 900 9-1 A-10  
OK2CM 834 6-1 A-9  
OK1NS 360 8-1 A-16

#### Danish—YM

YM4AA 75600 36-3 A-75

#### Denmark—OZ

OZ2M 50457 33-3 AB-72  
OZ4H 8120 20-2 --44  
OZ7SS 4563 13-3 --21  
OZ2H 3828 12-1 A-31  
OZ3D 1100 11-1 A- --  
OZ8Q 1020 10-1 B-11  
OZ9U 378 9-2 A-15  
OZ8B 100 5-1 A- --

### Estonia—ES

ES5D 6222- 17-2 A-44

### Finland—OH

OH2NB 17500- 25-3 A-43  
OH3NP 12768- 21-2 A-67  
OH5NF 1440- 15-3 A-35  
OH2OB 371- 7-1 A-10

### France—F

F8EO 151650- 50-4 A-84  
F8RR 53270- 35-3 A-88  
F8TQ 31359- 37-4 B-57  
F8ZF 21184- 32-4 A-61  
F8ZL 21075- 25-4 A-76  
F8JL 13079- 29-3 B-48  
F8JL 9680- 23-3 A-35  
F8JL 9108- 21-2 A-62  
F8GQ 6321- 21-2 A-22  
F8SN 5428- 23-4 --33  
F8NJ 4014- 18-2 A-32  
F8CP 3275- 15-2 -- --  
F8FC 3240- 18-2 B- --  
F8ZU 2136- 12-1 A-18  
F8CX 1851- 10-3 A-32  
F8AR 1470- 14-3 A- --  
F8WK 1368- 12-2 A-6  
F8OK 1272- 12-3 A-9  
F8AT 1141- 7-1 --17  
F8IL 735- 7-1 A-9  
F8PX 576- 8-2 A-16  
F8XE 312- 8-1 A-6  
F8II 48- 4-1 A-8  
F8NS\* 45- 3-1 -- --

### Germany—D

D4XCG 92389- 37-3 A-81  
D4WXD 27144- 26-4 --70  
D4QET 25018- 29-3 A-59  
D4BVF 24000- 32-4 A-88  
D4DLG 14816- 28-3 A-46  
D4SNL 14000- 20-3 A-70  
D4YLI 12008- 29-3 A-80  
D4XSR 10176- 24-4 A-79  
D4MNL 10032- 19-3 A-37  
D4YBF 8532- 18-2 A-34  
D4CDM 6636- 21-3 -- --  
D3CFH 7280- 20-3 A-46  
D3GKR 5148- 18-3 A-40  
D3CSC 4350- 15-2 A-55  
D4HCF 4218- 19-2 A-32  
D4XJF 4160- 16-2 A-80  
D4XQF 4104- 18-3 A-54  
D4GDF 3717- 21-2 A-40  
D4YVM 3480- 20-3 A-29  
D4SMO 3276- 14-2 A-40  
D4OYT 3105- 9-1 A-23  
D4WLL 3081- 13-2 A-34  
D4ZZH 2748- 12-1 A-43  
D4GFF 2355- 15-3 A-33  
D3GRH 1859- 13-2 -- --  
D3CUR 1764- 14-2 --11  
D4QNM 1512- 12-2 -- --  
D4NRF 1372- 14-2 A-23  
D4PEM 1200- 8-1 A-11  
D4ZPI 1062- 9-1 A-8  
D4IZI 1026- 9-1 A-11  
D4YWM 693- 11-3 A-16  
D4XVF 664- 8-1 A-10  
D4ADF 624- 3-1 A-16  
D4POU 602- 9-1 A- --  
D4RVC 600- 10-2 A-20  
D4GOF 600- 8-1 A-11  
D4UYD 550- 11-2 A-7  
D3GDK 480- 8-1 A-31  
D4WER 360- 5-1 A-16  
D4MOL 357- 7-1 A-9  
D4ORT 350- 7-1 A-9  
D4QPT 325- 5-1 A-8  
D4MDN 266- 7-1 A-6  
D3DRF 180- 5-1 A-19  
D4OAR 165- 5-1 A-6  
D4SGK 155- 5-1 A-8  
D4NWR 132- 4-1 A-10  
D4PQT 98- 3-1 A-12  
D4QBT 84- 4-2 -- --  
D3AUK 80- 5-1 A- --  
D3BK 18- 2-1 A-24  
D4BBF 18- 2-1 A-11  
D3FZI 16- 2-1 A-2  
D4GLF 12- 2-1 A-8

### Great Britain—G

G6NF 79280- 47-4 B-89  
G2PL 73968- 46-5 A-62  
G65YG 68355- 45-4 A-85  
G6LK 60630- 43-4 AB-73

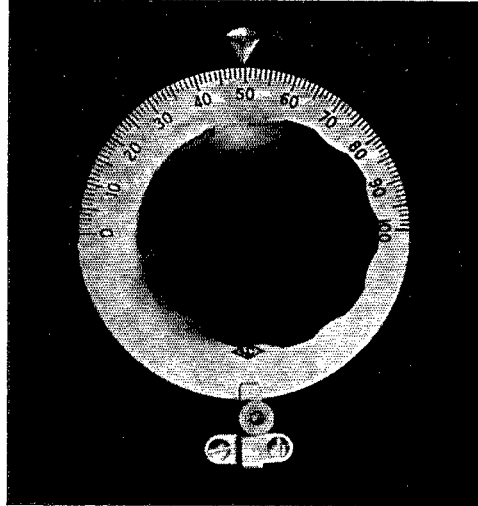

National Type O Dial, complete with index and grounding brush. Net Price... \$ .90

National Type ODL Lock. Net Price \$ .30

**NATIONAL COMPANY, INC., MALDEN, MASS.**

## TYPE O DIAL

THE O Dial has always been distinguished not alone for its appearance, but also for the very thorough way in which the dial scale is insulated from the shaft on which it mounts. For some applications, as in instrument use, it is desirable to ground the dial. For this purpose a small multi-contact brush is now packed with each dial. This device also provides a smooth friction load that makes adjustments steadier.

Where a positive clamp is desired, the new Type ODL Lock is available at a small extra charge. It is positive in action, and tightening it does not disturb fine adjustments, nor mar the fine finish of the dial.

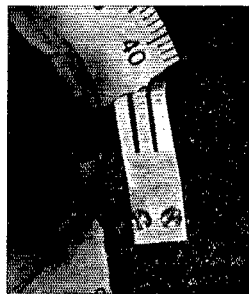

# R A D I O

**ENGINEERING**, broadcasting, aviation and police radio, servicing, marine radio telegraphy and telephony, Morse telegraphy and railway accounting taught thoroughly. Engineering course of nine months duration equivalent to three years of college radio work. School established 1874. All expenses low. Catalog free. **DODGE'S INSTITUTE**, Day Street, Valparaiso, Indiana

### SPECIAL TO AMATEURS

**Piezo-Electric Crystals — \$2.50 EACH POSTPAID**

Until supply is exhausted... we offer 80 meter band crystal unmounted; accurate calibration, excellent oscillators. Limited quantity.

### SCIENTIFIC RADIO SERVICE

"The Crystal Specialists Since 1925." University Park, Hyattsville, Md.

## Dodge Q R M

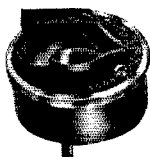

with the new Monitor Variable Frequency Control — 20 KC shift at 20 meters. AT crystal monel electrodes, any specified frequency in 80 meter band.  
**FOR ONLY.... \$5.50**

At your dealers or postpaid

**MONITOR PIEZO PRODUCTS CO.**

2802 West Avenue 32, Los Angeles

## HyVOL CAPACITORS



Ultra-compact oil-filled units. Using HYVOL — the super-dielectric oil.

Ideal anywhere — particularly in limited space.

Just compare quality and prices!

Welded steel case

Pillar type terminals

Positively leak-proof

Conservative ratings

1 to 4 mfd.

600 to 3000 v. D.C.

Write . . . .

New 32-page catalog just issued. Many new items. Chuck-full of vital radio data.



# YOU ARE INVITED

## To make this your buying headquarters

You can't go wrong because for 15 years we have been rendering a service unequalled in this business. Every leading manufacturer's line is listed here . . . and we can give you prompt, intelligent service based upon a personal understanding of your requirements.

## ■ OCTOBER SUNSLANTS ■ FIRST IN NEW YORK WITH THE AMERICAN CODE READER

**Another Sun Scoop!** Makes any station or listening post complete. Improves your "list"; copies code for you. Transforms code signals to a visual dot and dash record on tape. Come in and see it. . . . . \$12.00

## OTHER SPECIALS THIS MONTH

- National NC80X — Complete with Tubes, Speaker & Crystal. . . . . \$88.00 net  
Other National Receivers in stock. Write for brand new catalog!
- Hallicrafters 1938 Super SkyRider. Get details of Time Payment Plan and Free literature. Liberal allowance on your old receiver. . . . . \$2.40 net
- We are distributors for Western Electric Amateur equipment. Write for Free Tube Manual
- The new Taylor T125 in stock. . . . \$13.50 net  
All other types. Write for 40-page hand book. It's Free.
- New National Split-Stator Condenser. 50 MMF. Each section — 2000 volts. . . . . \$2.40 net
- RME-DB20 Presselector complete. . . . \$42.60  
COMPLETE STOCK OF THORDARSON TRANSFORMERS. Free literature on request.
- Stancor Filament Transformers .63 at 4 amps. . \$1.18  
2 1/4 volts at 10 Amps. . . . . \$1.14
- Stancor Plate Transformer. 750 volts at 200 M.A. Ideal for T20 or similar Tube. . . . . \$2.88
- The new 1938 Mackey DeLux. . . . . \$9.50
- Billey Crystal Units in stock A wide selection of frequencies. All types. Write for Free colored Frequency chart.
- HAMMARLUND SUPER PRO IN STOCK. Free literature on request.
- Ward Leonard Antenna Change Over Relay. 110 v. AC. . . . . \$5.88
- Meissner 1000 M.A. RF Choke. . . . . 38c
- Astatic — Brush — Shure — Turner — Microphones in stock. All types.
- The new Bud Transm. Free Catalog. All types. Single or split. Stator. *Write Catalog.*

## ■ GET OUR NEW FALL BARGAIN BULLETIN ■

Contains some real buys! Some close outs of items that you may be looking for. Latest dope on new items. Also timely articles by Sam Schwartz, Jack Grand and Ed Berliant. IT'S FREE



**SUN RADIO CO.**  
227 Fulton Street, New York, N. Y.  
Cable Address: SUNRADIO NEW YORK

GM6NX	51208-37-3--77	SP1LN	3828-12-1-A-41
G6WY	38663-41-4-AB-67	SPIER	912-12-2-A-13
G6RB	37713-39-4-A-73	SP1HJ	530-10-2-A-25
G2ZQ*	35080-40-4--78	SP1GZ	424-8-1-A-3
G6TW	33385-27-3-A-62	SP1MF	264-6-1-A-3
G6XN	33630-38-4-A-84		
G2NH	33478-38-4-AB-42	Roumania—YR	
G6QX	19074-34-4-B-57	YR5AA	70584-34-3-A-88
G6XL	19003-31-3-A-72	YR5CF	33316-19-2-A-63
G2MI	17794-31-3-B-65	YR5AR	8364-17-2-A-55
G6DT	15468-26-3-A-53	YR5TG	2640-20-3-A-34
G6CL	12069-27-3---	YR5CP	1056-8-1-A-13
G6CH	9018-18-2-A-48	YR5RY	3-1-1-A-1
G6QKH	6747-13-2--61	YR5ML	2-1-1-A-4
G5KA	6368-16-2-A-44		
G6DS	5478-11-1---	Sweden—SM	
G6YR	3519-17-3-A-13	SM7UC	49610-40-4-B-83
G2QA	3240-18-2-A-19	SM6SS	29750-34-4-A-79
G2VQ	3058-16-2-A-18	SM6WL	29274-34-3-B-62
G3AB	3034-16-2-A-30	SM6SO	19082-29-3-B-52
G6MC	2180-10-1--46	SM5VW	10704-24-3-A-38
G2HG	1914-11-1-A-18	SM6VX	4947-17-3-A-28
G2VZ	1162-7-2-A-11	SM5XW	4896-18-2-A-55
G5VU	1090-10-1-A-16	SM6ZF	3460-20-2-A-17
G2RD	792-11-2-A-11	SM6QP	2124-12-2-A-37
G5OJ	999-9-1-A-4	SM7UT	1638-13-2-A-28
G5FA	90-5-1-A-4	SM7YA	1053-9-2-B-8
G2GO	78-4-1-A-18	SM5WJ	441-7-1-A-7
G8JV*	12-2-1-A-3	SM5VJ	155-5-1-A-11
Hungary—HA			
HA8D	47730-30-3-A-80	Switzerland—HB	
HA8C	4320-37-3-A-97	HB9T	32980-34-4-A-55
HA8G	3000-10-1-A-28	HB9BY	26100-25-3-A-68
HA8C	1800-8-1-A-15	HB9BX	264-6-2-A-15
HA2B	76-4-1-A-5		
Irish Free State—EI			
EI8B	62010-45-4-B-31	Yugoslavia—YT/YU	
EI4J	56293-41-4---	YT7MT	670-10-1-A-13
EI4J	28392-28-3-A-79		
EI5F	7467-19-3-A-33	OCREANTA	
EI3J	5432-11-1---	Australia—VK	
EI0F	1780-10-1-A-18	VK3MR	74702-39-3-A-90
EI2M	1298-12-2-A--	VK3CP	60230-37-3-A-60
EI5G	714-7-1-A-10	VK3EC	31158-27-2-A-69
Italy—I			
ITKX	30750-30-3-AB-82	VK3UH	15466-27-2-A-43
IK1N	7434-21-2-A-45	VK2AD	15081-29-3-A-39
IT7	3373-11-1-A-37	VK3VN	15081-24-2-A-38
IT8	1932-12-1-A-55	VK6LJ	12229-19-2-A-37
IT7V	288-6-1-A-6	VK6SA	10647-21-3-A-40
IT8*	3-1-1---	VK2RA	10920-20-3-A-52
Latvia—YL			
YL2BB	19925-25-2-A-67	VK3XP	9288-27-3-A-45
YL2CD	13455-23-2-A-67	VK3WV	8946-21-3-A-21
Lithuania—LY			
LY1HB	6591-13-1-B-40	VK3JT	7125-19-2-B-16
LY1KK	560-9-1-A--	VK2NN	5434-13-1-A--
Malta—ZB1			
ZB1C	672-7-1-A-13	VK2AER	5206-19-2-A-14
Netherlands—PA			
PA0AZ	90285-39-3-A-87	VK2NQ	4954-13-1---
PA0QQ	56448-42-4-A-79	VK5KO	3773-11-1-A-22
PA0QF	12645-19-2-A-87	VK2NY	3218-17-2-A-35
PA0XR	11800-25-2-A-49	VK3CX	2052-9-1-A-14
PA0FLX	10237-29-4-A-74	VK4RC	1617-11-2-A--
PA0TSK	9660-20-3-A-84	VK2CI	2412-12-1-A-12
PA0GN	9006-19-2-A-36	VK4CG	1606-11-1-A-13
PA0OD	8664-24-3-A-41	VK3ZC	1352-13-2-A-35
PA0LF	7260-22-3-A-36	VK5LD	1155-11-3-A--
PA0AD	7242-17-3-A-64	VK2ABC	1134-9-1-A-11
PA0OK	370-13-2-A-8	VK3UW	1100-10-1-A-9
PA0TB	2284-12-1--36	VK4UR	888-12-2-A-15
PA0OE	1890-12-2-A-38	VK5JS	882-7-1---
PA0EA*	156-6-1---	VK2AEK	840-8-1--5
PA0DA	120-5-1-A-8	VK3VW	185-5-2---
PA0CH	48-4-3-A-5	VK5LL	165-5-1---
Northern Ireland—GI			
GI6TK	78081-51-4-A-64	Guam—K6	
Norway—LA			
LA2B	7460-20-3-A-40	K6JG	1610-7-1-B-20
LA4K	7200-16-2-A-69	Hawaiian Islands—K6	
LA3H	6030-15-2-A-44	K6CGK	163600-50-4-A-89
LA1M	4381-13-1-A-17	K6ILT	102949-49-4-AB-85
LA3V	1000-10-2-A-20	K6JPD	71685-45-4-C-46
LA2Q	234-6-2--15	K6AKP*	19775-29-5-B-24
Poland—SP			
SP1LM	5126-22-3-A-21	K6MXX	14500-24-2-B-22
SP1EB	4890-15-2-A-32	K6HZI	12144-12-1-A-50
New Zealand—ZL			
ZL4A	103800-40-3-A-76		
ZL1CK	7112-31-3-A-34		
ZL4AL	6867-21-2-A-27		
ZL2MN	6480-12-1-A-21		
ZL1BC	6003-23-2-A-21		
ZL3GR	5250-14-2-A-21		
ZL4BQ	3672-17-2-A--		
ZL1BE	3300-11-1--22		
ZL2NJ	2325-15-2-A-9		
ZL1DA	1476-9-1-A-19		
ZL1FE*	1070-10-1-A--		
ZL1LZ	315-7-1--5		

# The RADIO SHACK

46 Brattle St Boston

## TWO (2) STAR (★ ★) HAMGEAR SPECIALS

WE believe in specials when value-per-dollar quality accompanies a substantial saving to you. It pays to patronize the oldest New England Amateur supply house — for prompt and courteous service.

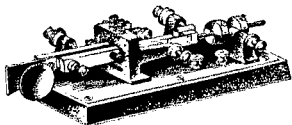

★ ★  
**\$3.45**

200 new KENCO KEYS — now a big saving for slim pocketbooks — your money back if you don't like it in one week — urs fer. . . . . **\$3.45**

★ ★  
**99¢**

**40M  
7200 —  
7500  
XTALS**

Regular 40 meter "X" cut xtals made by Nationally known mfr — 7200 to 7500 kc — IDEAL for new 28.5 30 MC fone — Fm Stock. . . . . **\$99**

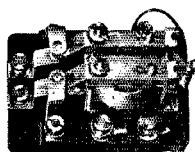

The Dunco CDB X 1 is used by many for break in operation. 110V AC or 6V DC control. CDB X 1 (DPSB). . . . . **\$6.60**

Keying and control. Relay — single CKT. ASB X 1. . . . . **\$3.85**

Time delay for 20 seconds — 110 AC TD 96. . . . . **\$8.80**

Heinemann overload circuit breakers — for quick action. 5 to 35 amps. . . . . **\$5.00**



If it's relays — we have 'em in stock

## UTC Plate Transformers and Chokes

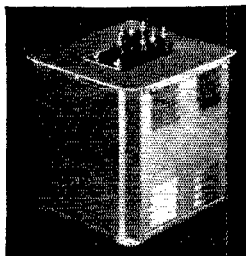

- 20462A—1000-750-0-750-1000 AC at 300 MA. DC. . . . . **\$5.20**
- 20462B—1500-1250-1000-0-1000-1250-1500 AC at 300 MA. DC. . . . . **6.75**
- 20462C—2500-2000-1500-0-1500-2000-2500 AC at 300 MA. DC. . . . . **10.95**
- 20462D—1500-1250-1000-0-1000-1250-1500 AC at 500 MA. DC. . . . . **10.95**
- 20462E—575-525-0-525-575 AC at 500 MA. DC. . . . . **5.20**

- 20462F—Smoothing Choke—20 Hy.-200 MA. 115 ohms DC Resistance. 2500 Volts Insulation . . . . . **\$1.45**
- 20462FS—Swinging Choke—5-25 Hy.-200MA. 115 ohms DC Resistance. 2500 Volts Insulation . . . . . **1.45**
- 20462G—Smoothing Choke—20 Hy.-300 MA. 95 ohms DC Resistance. 3500 Volts Insulation . . . . . **2.85**
- 20462GS—Swinging Choke—5-25 Hy.-300 MA. 95 ohms DC Resistance. 3500 Volts Insulation . . . . . **2.85**
- 20462H—Smoothing Choke—20 Hy.-400 MA. 85 ohms DC Resistance. 5000 Volts Insulation . . . . . **3.45**
- 20462HS—Swinging Choke—5-25 Hy.-400 MA. 85 ohms DC Resistance. 5000 Volts Insulation . . . . . **3.45**
- 20462I—Smoothing Choke—20 Hy.-550 MA. 55 ohms DC Resistance. 6000 Volts Insulation . . . . . **4.95**
- 20462IS—Swinging Choke—5-25 Hy.-550 MA. 55 ohms DC Resistance. 6000 Volts Insulation . . . . . **4.95**



Brush crystal phone and lorgnette handle. For hard-of-hearing amplifiers etc. — Excellent as amateur crystal microphone. **\$3.90**

Brush B2S sound cell — small size. Excellent quality for PA and radio work. . . . . **\$19.50**



Also Astatic crystal devices carried in stock

# Hallicrafters Hot Ham Hear 'em dx

1938 SX16, Best xtal ckt, Rollerskate Band Spread

IMMEDIATE DELIVERY — TIME PAYMENTS

★★ Also Taylor T-125's for **\$13.50** — and other "More Watts Per Dollar" Taylor tubes in stock — Raytheon RK47 es RK 48 beam tubes — Bassett concentric cable — Bliley mounted xtals — standard relay racks, **\$13.50** — standard panels 13 1/4" to 14" black crackled sheet steel — standard plated chassis and a wide selection of cabinets — Cardwell receiving es hi-power xmtng condensers — socket hole punches — meter hole cutters — Weston es Triplett meters es test gear — Aladdin IF transformers — Dials, grommets, soldering lugs, mounting strips, brackets, feed thru insulators, insulated washers, air dry black crackle at **50c** per can and all that necessary hardware for getting things in shape for Fall DX. Listened in on "ten" lately?

# W 3 U S A



## Boy Scout Jamboree Station SELECTS SHURE 70SW

Officials-in-charge of W3USA, ultra-modern shortwave station of the 1937 Jamboree of the Boy Scouts of America, selected the Shure 70SW as the microphone for their transmitter. The 70SW is the famous "Communications-Type" microphone that gives you double power on important speech frequencies.

See your Jobber or write for Bulletin 1371Q today!

Shure patents pending. Licensed under patents of the Brush Development Company.



## QUARTZ CRYSTALS

ALL TYPES. Low Temperature Coefficients. X and Y cuts Holders. Ground to any practical specifications. We can furnish crystals for new 28.5 to 30 megacycle bands; prices upon request.

Write for complete particulars  
**Bellefonte Radio Eng. & Mfg. Co.**  
BELLEFONTE, PA.



<i>Philippine Islands—KA</i>	XE1CM	6831-11-3	B-18
KAIUS 14040-18-2	XE1LM	1550-10-3	A--
KAI1MD 13540-20-2			
<i>Tasmania—VK7</i>	<i>Newfoundland—VO</i>		
VK7CL 5010-10-1	VO8X	31650-30-3	A-59
VK7PA 316-8-2	VO4Y	18792-24-3	A-40
VK7NG 350-7-2	VO1W	4454-17-2	A-15
	VO1N*	770-10-3	---
<i>NORTH AMERICA</i>	<i>Puerto Rico &amp; Virgin Is.—K4</i>		
<i>Alaska—K7</i>	K4DRN	1845-9-1	---
K7PQ 162968-52-5	K4SA	27-3-2	---
K7FST* 5800-20-3			
K7FSX 3026-16-3	<i>Windward Islands—VP8</i>		
	VP2LA	3120-12-1	A-22
<i>British Honduras—VP1</i>			
VP1WB 9958-13-1	<i>SOUTH AMERICA</i>		
<i>Canal Zone—K5</i>	<i>Argentina—LU</i>		
K5AY 253635-53-4	LU7AZ	47760-30-3	BC-66
K5AC* 129792-48-4	LU9BV	42738-34-3	A-85
K5AA 17640-14-1	LU7BK*	120-5-1	---
K5AJ 4260-12-1	<i>Bolivia—CP</i>		
W6BOY 378-7-1	CP1AA	3216-13-1	A-30
<i>Costa Rica—TI</i>	<i>Brazil—PY</i>		
TI2LR 13440-20-2	PY2AC	13392-24-2	B-39
TI2EA 1258-17-3	PY2BX	8448-12-1	A-36
<i>Cuba—CM</i>	PY2S	2250-10-1	A-21
CM2OP 6272-16-2	PY5AG	1001-11-1	A-10
<i>Leeward Islands—YP8</i>	<i>Columbia—HJ/HK</i>		
YP2AT 3798-18-2	HJ1JB	3820-20-2	--12
<i>Martinique—FM8</i>	<i>Chile—CE</i>		
FMSAD 94176-48-4	CE3AR	23577-29-3	BC-25
	CE1AQ	1323-9-1	A-22
<i>Mexico—XE</i>	CE4AD	375-5-2	---
XE2N 206415-55-5	<i>Peru—OA</i>		
XE1AM 22041-31-3	OA4J	72500-34-3	B-79

### 'Phone Scores

<i>ATLANTIC DIVISION</i>	<i>Indiana</i>		
<i>E. Pennsylvania</i>	W9YGC	15414-42-2	C-75
W3BLQ 11250-45-2	W9TMP	1350-15-1	B-60
W3FKC* 1740-20-2	W9LQ	1218-14-2	B-26
W3FVO 1504-16-1	W4DGR	324-9-1	B-123*
W3BRZ 294-7-1	W9IU*	243-9-2	---
W3ATR 252-9-1	W9SDQ*	60-4-1	---
	W9AKJ*	3-1-1	---
<i>Md.-Del.-D. C.</i>	<i>Kentucky</i>		
W3AKX 1950-13-1	W9ELL	1938-19-2	---
	W9YHQ*	231-7-1	---
<i>So. New Jersey</i>	<i>Michigan</i>		
W3CRG 21276-54-2	W8HZU	8555-29-1	C-47
W3AIR 19950-50-2	W8EJN	5568-29-2	C-35*
W3PC 17649-53-2	W8NJP	1302-14-1	B-16
W3ZX 7525-35-2	W8QDU	1206-18-2	B-16
W3EBC 2060-20-2	W8CIS	459-9-1	B-26
W3GIP 432-9-1	W8ISC	390-10-1	B-4
W3EDP 210-7-1	W8BWB	281-9-1	B-8
W3FKK 90-5-1	W8IFD	103-6-1	B-25
W3ENZ 18-2-1	W8KO	66-3-1	B-4
	W8DLT	12-2-1	A-9
<i>W. New York</i>	W8IQS		
W8JNU 2261-19-1	<i>Ohio</i>		
W8HQW 1620-20-1	W8NV	6265-35-2	AB-32
W8CYT 1566-18-2	W8ANO	2100-14-2	B-9
W8AU 216-8-2	W8MDU	2100-21-1	B-21
W8POL* 84-4-1	W8JFC	1755-15-1	A-19
	W8SY	504-12-2	B-73*
<i>W. Pennsylvania</i>	W8DIA*	330-10-1	---
W8GLY 18258-51-2	W8LFE	30-2-1	B-4
W8KBJ 528-11-1	W8BYM*	12-2-1	A--
W8OKC 360-9-1	W8CHB*	12-2-1	B--
	W8MEV*	3-1-1	---
<i>CENTRAL DIVISION</i>	W8JLQ	3-1-1	---
<i>Illinois</i>	<i>Wisconsin</i>		
W9DKU 19551-49-2	W9RBI	1506-19-2	A-43
W9QI 9072-36-2	W9RNX	272-8-2	B-22
W9WXT 972-12-1			
W9NLP 972-9-1	<i>DAKOTA DIVISION</i>		
W9IVG 612-12-1	<i>North Dakota</i>		
W9BU 374-11-2	W9EOZ	418-11-2	B-7
W9WC 324-9-3	<i>South Dakota</i>		
W9PXS* 252-7-1	W9PZI	351-9-1	A-8
W9PTX* 48-4-1	<i>So. Minnesota</i>		
W9GIC* 45-3-2	W9NNO	2717-19-1	B-39
W9MLJ* 12-2-3	W9ORL	368-8-1	B--
W9GSD* 12-2-1			
W9MBQ 12-2-1			
W9JGS 3-1-1			



# New JOHNSON Ceramic Parts

Featuring the surprisingly low-loss ALSIMAG 196\*

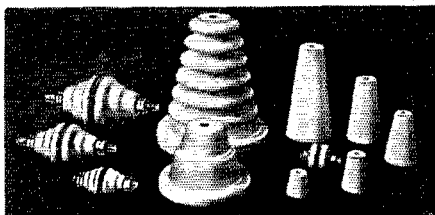

Illustrated are five cone shaped tapped stand-off insulators of Alsimag 196. Heights range from 5/8" to 3", supplying every need for transmitters requiring the utmost in insulator performance. A small (3/4" diameter) panel bushing of Alsimag 196 is shown nearest this group.

New Johnson porcelain parts include five tapered cone insulators (right) in the same sizes as the Alsimag 196 cones. Furnished complete with cushion washers, machine screws both top and bottom, and in four jack types. Above, are five sizes of porcelain lead-in bushings.

Johnson porcelain insulators may be used with confidence wherever the unusual characteristics of Alsimag 196 are unnecessary.

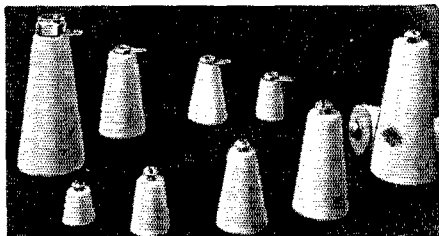

**E. F. JOHNSON COMPANY**  
 MANUFACTURERS OF *Radio Transmitting Equipment*  
 WASECA MINNESOTA U.S.A.

Export Office: 25 Warren St., New York. Cable: "SIMONIRILE"

\* Alsimag 196, which we consider the finest ceramic insulation available for radio use, is also employed in all Johnson condensers (see Sept. QST), Johnson ceramic wafer sockets (see Aug. QST), and many other parts.

Ask your Jobber or Write us for our 1938 Catalog 964J

## GULF RADIO SCHOOL

Radiotelegraphy Radiotelephony  
 Radio Servicing

SECOND PORT } 1007 Carondelet Street  
 U. S. A. } NEW ORLEANS, LA.

Here's a Hint—

## GET HINTS AND KINKS

Volume 2, postpaid, 50 cents

AMERICAN RADIO RELAY LEAGUE, West Hartford, Conn.



**NEW HOLDER DESIGN**  
 15 SECONDS TO  
 INSTALL CRYSTAL

For All Bands  
 GREATER STABILITY  
 Plugs in 5 prong tube socket  
 Beautiful Appearance

**MODEL AH HOLDER \$1.00** At your dealer or direct

**HIPOWER LOW DRIFT CRYSTALS:**  
 within 10 kc. or Choice of stock

AH-10, 1700-3500 Kc. bands \$2.35  
 AH-10, 7000-7300 " band 3.90

WRITE FOR NEW LITERATURE

Hipower "Low Drift" Broadcast and Commercial Crystals Are Approved by F.C.C.

Hipower Crystal Co., 2035 Charleston St., Chicago

## \$100 for a RADIO KEY!?!?

**WORTH IT, but I only charge \$9.50**

No "hokey" about it. This semi-automatic key really steps up your speed. Dot-stabilizer equipped — most remarkable feature ever offered! Main spring Swedish steel, tensioned and balanced. Case-hardened pins and screws. Bakelite used throughout — no fibre. Big solid base stays put. Rich Marbleite finish. Metal parts chrome plated. Proper height for tireless rhythmic sending. Order your new 1938 De Luxe Model MAC key today! Only \$9.50.

MAC Oscillator, \$4.50. Also New MAC Straight Key, the best there is — only \$1.50. Write for complete dope on other MAC items of tremendous help to radio ops. Immediate delivery on everything!

**T. R. McELROY—175 Congress St., Boston, Mass.**  
 WORLD'S CHAMPION TELEGRAPHER

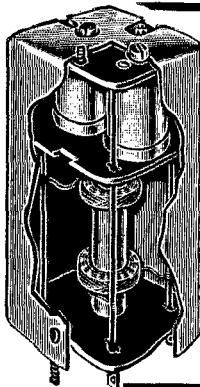

*Meissner*

## AIR-TUNED I.F. TRANSFORMERS

The only air-tuned I.F. transformer offering 3600 degrees tuning.

Align-air trimmers used, are permanently stable, moisture proof, dust proof and temperature proof. Completely eliminates "Drift."

Available in all frequencies in either Iron Core (Ferrocart) or Air Core.

FREE: Write for our new 32-page descriptive catalog.

**MEISSNER MFG. CO.**  
 MT. CARMEL, ILLINOIS



Whether the commodity to be bought is merchandise or a service . . . a transmitter or a travel tour . . . the wise and experienced buyer looks closely at the reputation of the company who sells it. HARVEY has earned the confidence and goodwill of amateurs everywhere . . . through an earnest endeavor to give them a BIGGER value for their "ham" dollar.

## TAYLOR T-20, T-55 TRANSMITTER KITS

This very fine transmitter is the first medium power rig that will work as efficiently on 160 meters as on 10. This is made possible through a unique arrangement used by Earl Anderson, whereby the split stator condenser is used in a parallel arrangement on 160 meters and in series on the high frequency bands. All this is accomplished in the base arrangement of the plugs. Since insulation plays an important part in high frequency operation, only the best quality parts are used in this transmitter.

We furnish CARDWELL condensers, NATIONAL coil forms and sockets, UTC transformers, IRC insulated resistors, SANGAMO and CORNELL-DUBILIER condensers, a drilled and punched black crackle chassis (so that all the hard work is finished, and all that remains is a few hours of simple wiring.)

We also furnish a complete kit of coil forms and wire, exactly as shown on page 23 of the June, 1937, issue of QST. The power supply for the T-55 stage is made to deliver as high as 1300 volts at 300 ma. This allows for the addition of another T-55 at some future time. The power supply has a tapped arrangement for 850 volts, 1060 volts or 1300 volts. The smaller supply will deliver 500 volts at 200 ma.

Net price for transmitter kit . . . . .	<b>\$39.95</b>
Net price for power supply kit . . . . .	<b>18.95</b>
Net price for low voltage kit . . . . .	<b>9.95</b>
Net price for Taylor T-20 . . . . .	<b>2.45</b>
Net price for Taylor T-55 . . . . .	<b>8.00</b>
Net price for Taylor 806 Jr. . . . .	<b>1.00</b>
Net price for RCA 6L6 . . . . .	<b>1.35</b>
Net price for RCA 83 . . . . .	<b>.96</b>

OUR *Best* VALUE IS OUR RECORD OF LOYAL SERVICE

# HARVEY

## Radio Company of New York

103 WEST 43rd STREET • NEW YORK, N. Y.

CABLE ADDRESS: "HARADIO"

<i>No. Minnesota</i>		<i>W7CPY*</i>		18-	2-2-	A- -
W9TPL	12-	2-1-	---	<i>Oregon</i>		
<i>DELTA DIVISION</i>		<i>W7AO</i>		6989-	29-3-	C-66
<i>Arkansas</i>		<i>W7MD</i>		1938-	19-2-	C-39
W5ASG	11211-	37-2-	B-65	<i>W7FU</i>	624-	13-2- B-24
<i>Louisiana</i>		<i>W7DNP*</i>		148-	4-1-	---
W5BMM	3298-	17-2-	B-28	<i>W7DAA</i>	120-	5-1- B- 8
W5KC	24-	2-1-	A- 5	<i>Washington</i>		
<i>Tennessee</i>		<i>W7AXS</i>		513-	9-2-	B-21
W4DQH	288-	8-1-	B- 3	<i>W7ETX</i>	6-	1-1- ---
W4DCK	3-	1-1-	---	<i>ROANOKE DIVISION</i>		
<i>HUDSON DIVISION</i>		<i>North Carolina</i>				
<i>E. New York</i>		<i>W4AH</i>		43064-	56-3-	C-68
W2CBO	16290-	45-3-	B-48	<i>W4TO</i>	14896-	44-2- B-38
W2HHU	4862-	26-2-	B-81	<i>W4DCQ</i>	10740-	30-1- B-61
W2HCE	2304-	16-1-	B-24	<i>W4OC</i>	6525-	29-1- C-32
W2FBA	344-	8-1-	---	<i>Virginia</i>		
<i>N. Y. C. &amp; Long Island</i>		<i>W3EMM</i>		34574-	59-3-	B-49
W2UK	39753-	63-2-	C-89*	<i>W3FGJ</i>	6758-	31-2- B-31
W2LXY	15680-	35-1-	B-57	<i>W3BEK*</i>	400-	10-1- ---
W2AYJ	882-	14-2-	B- -	<i>W3DHW</i>	324-	9-1- B-10
W2DQV	702-	13-1-	B- 8	<i>W3AVR*</i>	60-	4-1- ---
W2CVI*	162-	6-1-	---	<i>W3RL</i>	44-	4-1- A- 4
W2AOL	60-	4-1-	A- 4	<i>W3FPQ*</i>	12-	2-1- ---
W2ILO*	27-	5-1-	A- 3	<i>W3PPL*</i>	3-	1-1- ---
<i>No. New Jersey</i>		<i>West Virginia</i>		<i>W8CXR</i>		
W2JME	32147-	61-2-	B- 86	3720- 30-2- B-41		
W2MJ	16320-	34-1-	---	<i>ROCKY MTN. DIVISION</i>		
W2ETH	3220-	23-1-	B-43			
W2DJT	2860-	22-1-	B-16	<i>Colorado</i>		
W2JAB	504-	9-1-	A-34	<i>W9PWU</i>	598-	13-2- A- 3
W2JUG	259-	9-1-	B- 6	<i>W9PGB</i>	168-	7-1- A- 6
W2IUT	204-	2-1-	---	<i>Utah-Wyoming</i>		
W2DLF	3-	1-1-	---	<i>W6DTE</i>		
W2HFP	3-	1-1-	---	2898- 23-2- B-24		
<i>MIDWEST DIVISION</i>		<i>PACIFIC DIVISION</i>				
<i>Iowa</i>		<i>Santa Clara Valley</i>				
W9MCD	1995-	19-2-	--31	<i>W6KM</i>	8745-	33-2- C-83
W9JOL	253-	6-1-	B-14	<i>W6PYY</i>	1820-	15-1- B-42
W9FDL	65-	5-1-	A- 4	<i>W6EJT</i>	1512-	18-2- ---
W9SBV*	60-	4-1-	B- -	<i>W6BJB</i>	456-	8-2- A-25
<i>Kansas</i>		<i>W6EX*</i>		288-	8-3-	---
W9BEZ	12520-	40-2-	B-60	<i>W6IWS</i>	216-	6-2- A-15
W9PVP	6032-	29-2-	B-49*	<i>W6DL</i>	210-	7-2- ---
W9FDE	540-	10-2-	A- 98*	<i>W6KQK</i>	54-	3-1- ---
W9BPL	539-	11-2-	B-15	<i>W6LYO</i>	48-	2-1- A- 8
W9VZL	12-	2-1-	A- 3	<i>W6MUR</i>	3-	1-1- B- 1
<i>Missouri</i>		<i>East Bay</i>				
W9ARA	45445-	61-2-	C-90	<i>W6ITH</i>	22836-	44-4-AC-84
W9PZZ	2380-	20-2-	B-70	<i>W6OCH*</i>	2781-	27-1- --26
W9PGN	105-	5-1-	A- 8	<i>W6MMK</i>	84-	4-1- A- 6
<i>Nebraska</i>		<i>W6KRM</i>		12-	2-1-	---
W6BBS	528-	11-2-	B-42	<i>W6JJ*</i>	3-	1-1- ---
W9MGV	330-	6-1-	B-20	<i>San Francisco</i>		
<i>NEW ENGLAND DIVISION</i>		<i>W6BAY</i>		15085-	35-3-	--57
<i>Connecticut</i>		<i>W6CLS</i>		2565-	19-2-	--43
W1COJ	8736-	32-2-	A-57	<i>Sacramento Valley</i>		
W1SZ	23591-	58-3-	B-60 <sup>14</sup>	<i>W6EJC</i>	10362-	33-2- B-67
<i>E. Massachusetts</i>		<i>San Joaquin Valley</i>				
W1ADM	14220-	45-3-	C-52	<i>W6MVK</i>	6552-	26-2-BC-31
W1DNL	5481-	29-2-	BC-19	<i>W6CQI</i>	3100-	20-1- C-29
W1BLO	4998-	21-1-	C-31	<i>W6GCA</i>	135-	5-2- A- 5
W1TW	3848-	26-2-	B-29	<i>SOUTHEASTERN DIVISION</i>		
W1BTL	2940-	21-1-	B-17			
W1AXA	2601-	17-2-	--25	<i>Alabama</i>		
W1WV	1238-	14-1-	AB-38	<i>W4DGS</i>		
W1CUY*	600-	10-2-	---	4758- 26-2-AB-27		
W1KJ*	561-	9-1-	---	<i>E. Florida</i>		
W1DJK	84-	4-1-	A- 6			
W1GDY*	72-	4-1-	---	<i>W4AGB</i>	21024-	48-2- B-71
W1JIL	3-	1-1-	---	<i>W4CYU</i>	16100-	50-2- B-65
W1HKY	3-	1-1-	---	<i>W4DLH</i>	6119-	29-1- B-24
<i>W. Massachusetts</i>		<i>W4CPG</i>		5888-	32-2- AB-34	
W1AQM	1545-	15-1-	B-18	<i>W4QN</i>	2461-	23-3- A-48
W1DSK	561-	11-1-	B-17	<i>W4EGN</i>	180-	6-1- A-14
W1DYA	12-	2-1-	---	<i>W. Florida</i>		
<i>Vermont</i>		<i>W4CRA</i>		1296-	16-1-	C- -
W1DQK	1712-	16-1-	B-23	<i>Georgia</i>		
W1ELR	1680-	16-2-	B-18			
<i>NORTHWESTERN DIVISION</i>		<i>W4CBY</i>		28235-	53-2-	C-70*
<i>Montana</i>		<i>W4YV</i>		11137-	37-1-	B-43
W8SNP	312-	8-1-	A-10 <sup>30</sup>	<i>W4YC</i>	4774-	31-2- B-47*
		<i>W4EBV*</i>		1058-	23-1-	B-37
		<i>W4EFS</i>		45-	3-1-	A- 1



## BRAND NEW SYLVANIA 211C

These tubes are especially designed for high-frequency use and are not to be confused with other types of 211 tubes which are designed for audio use only. However two of these in class B will deliver 260 watts audio. The rated dissipation of the carbon plate is 100 watts. With exception of the lower interelectrode capacities the characteristics are similar to the standard UV211. Just a few left. . . . \$6.75  
White Vitrolex 50 watt sockets. . . . . \$1.50

## Thordarson Ham Specials

### PLATE TRANSFORMERS

Shielded cases — tapped primary — air cooled construction — porcelain high tension terminals.

- T-16P00. D.C. volts 650 or 500 @ 200 MA. Price. . . . . \$3.88
- T-16P01. D.C. volts 1250 or 1000 @ 300 MA. Price. . . . . \$7.64
- T-16P02. D.C. volts 1250 or 1000 @ 500 MA. Price. . . . . \$12.35
- T-16P03. D.C. volts 1800 or 1450 @ 300 MA. Price. . . . . \$11.17
- T-16P04. D.C. volts 2500 or 2000 @ 300 MA. Price. . . . . \$13.67

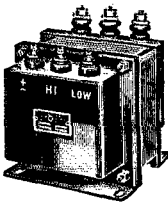

### FILAMENT TRANSFORMERS

Open style sub or top panel mounting.

- T-16F08. 2 1/2 volts C.T. @ 5 1/2 Amps 2000 volts ins. Price. . . . . \$8.88
- T-16F09. 2 1/2 volts C.T. @ 10 Amps 2000 volts ins. Price. . . . . 1.03
- T-16F10. 2 1/2 volts C.T. @ 10 Amps 7500 volts ins. Price. . . . . 1.62
- T-16F11. 5 1/2 volts C.T. @ 4 Amps 2000 volts ins. Price. . . . . 1.18
- T-16F12. 5 1/2 volts C.T. @ 13 Amps 2000 volts ins. Price. . . . . 2.86
- T-16F17. 6.3 volts C.T. @ 3 Amps 2000 volts ins. Price. . . . . 1.03
- T-16F13. 7 1/2 volts C.T. @ 4 Amps 2000 volts ins. Price. . . . . 1.18
- T-16F14. 7 1/2 volts C.T. @ 8 Amps 2000 volts ins. Price. . . . . 1.91
- T-16F15. 10 volts C.T. @ 4 Amps 2000 volts ins. Price. . . . . 1.76
- T-16F16. 10 volts C.T. @ 8 Amps 2000 volts ins. Price. . . . . 2.35

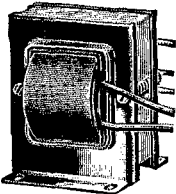

### INPUT CHOKES

- T16C20. 5/20 h — 200 ma — 2000 v ins. Price. . . . . \$2.20
- T16C21. 5/20 h — 300 ma — 3000 v ins. Price. . . . . 2.94
- T16C22. 5/20 h — 500 ma — 3000 v ins. Price. . . . . 5.28

### SMOOTHING CHOKES

- T16C25. 12 h — 200 ma — 2000 v ins. Price. . . . . \$2.20
- T16C26. 12 h — 300 ma — 3000 v ins. Price. . . . . 2.94
- T16C27. 12 h — 500 ma — 3000 v ins. Price. . . . . 5.28

## Kenyon Ham Specials

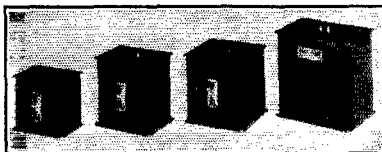

### SMOOTHING CHOKES

- D-100. 20 Henries, 200 MA. . . . . \$1.50
- D-102. 20 Henries, 300 MA. . . . . 2.90
- D-104. 20 Henries, 400 MA. . . . . 3.50
- D-106. 20 Henries, 500 MA. . . . . 5.00

### SWINGING CHOKES

- D-101. 5/25 Henries, 200 MA. (2500 volt insulation) . . . . . \$1.50
- D-103. 5/25 Henries, 300 MA. (2500 volt insulation) . . . . . 2.90
- D-105. 5/25 Henries, 400 MA. (5000 volt insulation) . . . . . 3.50
- D-107. 5/25 Henries, 500 MA. . . . . 5.00

### POWER TRANSFORMERS

- D-200. 750-1000 volts each side of center tap at 300 MA DC. . . \$5.25
- D-201. 1000-1250-1500 each side of center tap at 300 MA DC. 6.80
- D-202. 1500-2000-2500 each side of center tap at 300 MA DC. 11.00
- D-203. 1000-1250-1500 each side of center tap at 500 MA DC. 11.00

## All the New TAYLOR TUBES IN STOCK

- TZ20 zero bias triode, 20 watt pl. dis. . . . . \$2.45
- T125 high frequency triode, 125 watt pl. dis. . . . . \$13.50

## The new MAC KEY BUG

Price. . . . . \$9.50

## 8OX — NEW NATIONAL — 8IX

### THE NC-8OX RECEIVER

Ten tubes, crystal filter, controllable selectivity from 200 to 10,000 cycles, automatic coil shifting, complete frequency coverage from 9 1/2 to 600 meters, self contained power pack, permanent magnet dynamic speaker, calibrator mechanical bandsread. Net price complete with tubes, crystal, and speaker chassis . . . . . \$88.00

### THE NC-8IX RECEIVER

Same as above, but a strictly amateur band model, providing extreme calibrated bandsread on the amateur bands, with no frequency cov-

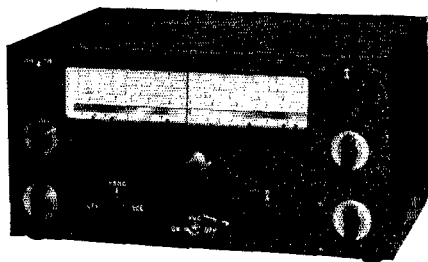

erage between bands. Net price complete with tubes, crystal, and speaker chassis \$88.00

- Triad 866 Tubes (a real value) . . . . . 99c
- Brush Crystal Phones (make sw-ll xtal mikes) . . . . . \$5.29
- Johnson 5 Meter "Q" Antenna Systems in Stock. . . . . \$3.83

- The New Raytheon RK49 Beam Tube (improved 6L6G with isolantite base). Price. . . . . \$2.10
- Crackle Finished Steel Chassis Bases 17 x 10 x 3. . . . . 90c
- 12 x 10 x 3. . . . . 75c

# M & H SPORTING GOODS CO.

512 Market St., Philadelphia, Pa.

1709 Atlantic Ave., Atlantic City, N. J.

Say You Saw It in QST — It Identifies You and Helps QST



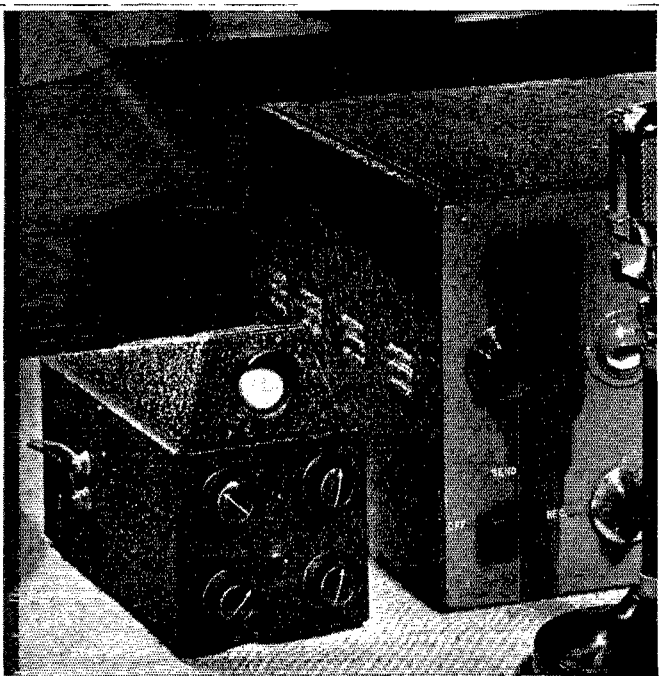

## A MINIATURE OSCILLOSCOPE AT A LOW PRICE

The Type CRM Oscilloscope employs the little RCA-913 tube having a one-inch screen. In spite of its small size, this new equipment is thoroughly practical and is quite satisfactory for routine measurements in the amateur station. The circuit includes a power supply with controls for brilliancy and focus, a potentiometer for controlling the amplitude of the horizontal deflection, and a built-in 60-cycle sweep. This latter is particularly convenient as it permits checking transmitter operation with no connection other than a pick-up coil.

**NET PRICE \$11.10**  
Without Tubes

**NATIONAL COMPANY, INC.**  
MALDEN, MASS.

## MAKE THEM WANT A QSO

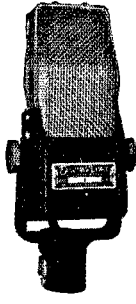

The smooth response of this new velocity microphone originates the kind of signal that you, yourself, like to hear. Work more stations more easily.

See your jobber. Write for catalog.

**ELECTRO-VOICE**  
MANUFACTURING CO.

326 E. Colfax Ave., South Bend, Indiana  
Export: 100 Varick St., New York City

## MODULATION METER



Approved by  
Leading Transmitter  
Kit Manufacturers

BASED ON F. C. C.  
BC SPECIFICATIONS

SEE YOUR JOBBER  
QSL FOR CIRCULAR

**\$19.75 f. o. b.** J-M-P MANUFACTURING CO.  
3042 No. 34th Street - Milwaukee, Wisc.

## IN STOCK

Model	Cash Price	Down Payment	12 Monthly Payments
RME-69	\$151.20	\$30.24	\$10.81
Bretina 14	108.00	21.60	7.75
PR-15	109.50	21.90	7.86
Super Pro	238.14	47.62	16.95
AGR-155	74.50	14.90	5.38
AGR-111	189.50	37.90	13.51

See Hallicrafter prices in my ad page 2

All receivers shipped on ten day trial. You need send but \$5.00 with order. Trade in your receiver. Buy on my own 6% plan and save. Write for information. Your inquiries are invited.

## HENRY RADIO SHOP

211-215 North Main Street BUTLER, MISSOURI

## Announcing THE FOURTH EDITION of EXPERIMENTAL RADIO

(196 p. 6 x 9 cloth. 136 experiments. 167 figures). By Professor R. R. Ramsey, Ind. Univ. A revision of the original book for experimenters and students. Diagrams drawn for power packs and batteries. Many new and original ideas. The earlier editions were the first books to contain new features which are accepted now. Of this edition again it can be said, "Ramsey manages to supply that missing fact which seems to be hidden in other books"



## FUNDAMENTALS of RADIO

Second, 1935 edition. By the same author. A modern text book with a minimum of mathematics giving fundamental theory of radio. Practice may change; Basic principles remain the same. Price, Experimental \$2.75. Fundamentals \$3.50 postpaid.

Ramsey Publishing Co., Bloomington, Indiana

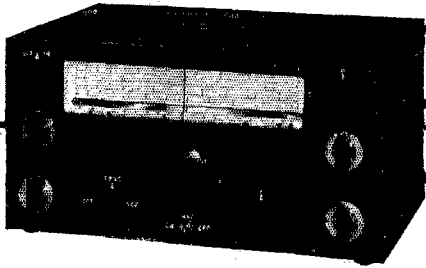

## NATIONAL MODEL NC80X

**\$88.00** COMPLETE WITH TUBES  
CRYSTAL FILTER, 8" P. M.  
SPEAKER CHASSIS

### SERVICE OR BUST!

THAT our '36-'37 season was the biggest the Connecticut amateur ever gave us may be because —

☐ We mean to give the Ham a service that is complete. Complete with the best national "special buys," the best national standard parts, those trick parts you need when you need them.

☐ We save the Conn. lad gas and oil costs, transportation costs, time and trouble in a dozen ways, with three stores.

☐ We provide a convenient, sensible time-payment plan.

☐ We won't sell some components we know mean trouble. Experience as wide as ours is good for something.

☐ We are thorough in reconditioning used communication receivers. So thorough they are guaranteed and last.

☐ We meet trouble squarely in order that it may not cost the customer more than its accidental inconvenience.

### Time Payments for Conn. Hams

# HATRY & YOUNG

HARTFORD . . . . . 203 ANN ST.  
NEW HAVEN . . . 86 MEADOW ST.  
BRIDGEPORT . . 177 CANNON ST.

**Radio Since 1912**

<i>Barbados—VP6</i>		VK4BS	288-	6-1	---
VP6YB	2790- 9-1	B-11	VK3HL	231-	6-1
<i>Bermuda—VP9</i>		VK4CG	168-	4-1	---
VP9G	7786- 17-2	---34	VK2QH	126-	6-1
VP9R	5577- 13-1	A-27	VK3VD*	60-	4-1
<i>Canal Zone</i>		VK3CP	60-	2-1	---
K5AF	2565- 15-2	B-18	VK4GG*	60-	3-1
<i>Costa Rica—TI</i>		VK5KO*	45-	3-1	---
TI3AV	4676- 14-1	A-14	VK3VW	3-	1-1
TI2EA	620- 10-2	---	VK3HM	3-	1-1
			VK3HQ	3-	1-1
<i>Cuba—CO</i>		<i>Hawaiian Islands—K8</i>			
CO2ON	12138- 14-1	B-73*	K6MVV	63180-	26-2
CO2WM	5057- 13-1	A-36	K6CGK	12660-	20-3
CO8AE	828- 9-1	A- 7	K6MZK*	3-	1-1
CO2MT	528- 8-1	---	<i>Java—PK</i>		
CO2HY*	3- 1-1	---	PK3LC	784-	7-1
			PK3ST	623-	7-1
<i>Dominican Republic—HI</i>		<i>New Zealand—ZL</i>			
HI7G	1632- 11-1	B- -	ZL4AO	736-	8-1
<i>Mexico—XE</i>		<i>Philippine Islands—KA</i>			
XE2N	64311- 39-4	B-51	KA1MD	108-	3-1
XE1AX	6328- 14-1	B-28	<i>Tasmania—VK7</i>		
XE3AC	1690- 10-1	---	VK7CL	336-	7-1
<i>Newfoundland—VO</i>		<i>South America</i>	VK7JB	294-	7-1
VO2N	1958- 11-2	A-17	<i>Argentina—LU</i>		
<i>Porto Rico—K4</i>		<i>Bolivia—CP</i>			
K4EPO	8635- 11-1	B-54	CP1AA	1639-	11-1
K4SA	372- 6-1	---	<i>Brazil—PY</i>		
<i>OCEANIA</i>		<i>Chile—CE</i>			
<i>Australia—VK</i>		CE1AH	1910-	10-1	B-25
VK2GU	24096- 24-2	---47	CE3DW	1881-	11-1
VK3MR	9420- 20-2	---66	<i>Colombia—HK</i>		
VK2ABG	6612- 12-1	A-52	HK1GK	10697-	19-2
VK3ZL	5447- 13-1	A-50	HK1ABM	2002-	11-1
VK2HF	4788- 12-1	---	<i>Peru—OA</i>		
VK2IQ	3300- 11-1	A-33	OA4AB	2574-	11-1
VK2CP	3124- 11-1	A-30			
VK2OQ	2079- 11-1	---			
VK6MW	2060- 12-1	A- -			
VK5JC	1026- 9-1	---14			
VK3IW	765- 9-1	--- 9			
VK2VV	552- 8-1	---			
VK2TC	528- 8-1	---			
VK4RG	420- 7-1	---			
VK3HY	416- 8-1	---			
VK2NY	360- 8-1	A-19			

### How Would You Do It?

(Continued from page 38)

Prizes of \$5 worth of A.R.R.L. station supplies or publications will be given to the author of the solution considered best each month, \$2.50 worth of supplies to the author of the solution adjudged second best. The winners should, of course, state the supplies preferred.

### Hints and Kinks

(Continued from page 48)

pattern.  $R_1$  is the volume control and  $R_2$  is not touched again unless necessary on a later check.

At current costs of parts, it adds not more than \$2.00 to the cost of an amplifier to build in this balancing unit. It should of course be recognized that here is no compensation for dissimilarity of power tubes, such as when half the filament of a 2A3 burns out unnoticed!

—A. H. Taylor, Cornell University, Ithaca, N. Y.

Note: It is desirable to avoid loading the speech-amplifier tubes insofar as this is possible with a grid detector connected across the output circuit. To this end, the sum of  $R_7$  and  $R_8$  should be large compared to the value of  $R_3$ . This condition is

## THE NEW 1938 SUPER SKYRIDER

Net Price Complete, Less Speaker and Crystal . . . . . \$99.00  
 Extra for Crystal, \$12.00 Extra for Speaker, \$12.00  
*Time Payments on All Hallicrafters Receivers*

RME-69. COMPLETE WITH CRYSTAL AND SPEAKER  
 Net \$151.20

WE SPECIALIZE ON GARDWELL CONDENSERS

### TRIPLETT METERS

Flush Mtg. 2" Black Bakelite Case, 0-1 MA. D.C., \$3.75;  
 0-50, 0-100, 0-200, 0-300 or 0-500 MA. D.C., each \$2.94  
 Flush Mtg. 3" Black Bakelite Case, 0-1 MA. D.C., \$4.56;  
 0-50, 0-100, 0-200, 0-300, 0-500, or 0-1000 MA. D.C.  
 each \$3.75.

## KENYON SPECIALS

### POWER TRANSFORMERS

D200. 750-1000 V. each side at 300 mils. . . . . Net \$5.25  
 D201. 1000-1250-1500 V. each side at 300 mils. . . . . " 6.80  
 D202. 1500-2000-2500 V. each side at 300 mils. . . . . " 11.00  
 D203. 1000-1250-1500 V. each side at 500 mils. . . . . " 11.00

### SMOOTHING CHOKES

D100. 20 Henries — 200 mils. 2500 V. insulation . . . . . Net \$1.50  
 D102. 20 Henries — 300 mils. 2500 V. insulation . . . . . " 2.90  
 D104. 20 Henries — 400 mils. 5000 V. insulation . . . . . " 3.50  
 D106. 20 Henries — 500 mils. 6000 V. insulation . . . . . " 5.00

### SWINGING CHOKES

D101. 5-25 Henries — 300 mils. 2500 V. insulation . . . . . Net \$1.50  
 D103. 5-25 Henries — 400 mils. 2500 V. insulation . . . . . " 2.90  
 D105. 5-25 Henries — 400 mils. 5000 V. insulation . . . . . " 3.50  
 D107. 5-25 Henries — 500 mils. 6000 V. insulation . . . . . " 5.00

### THE FINISHING TOUCH!

## Gordon World-Wide GMT and Standard Time Clock

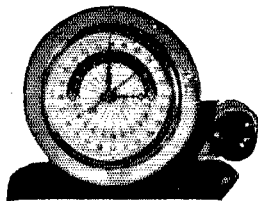

60-Cycle Self-Starting  
 Genuine Waltham 24-  
 Hour Movement. Base  
 removable for panel  
 mounting (Hole size  $3\frac{1}{4}$ " ). Satin Black Finished Base holds  
 clock in reclining position for easy reading. Tells at a glance  
 GMT and Local Standard Time in 24 principal countries  
 around the globe. Tells the time in each of the 24 time zones  
 around the world. And your net cost is only . . . . . \$9.00

### "X" Cut Unmounted 40 Meter Crystals

Made by nationally known manufacturer. Your choice from our  
 stock, only \$1.95. These are 1" square and have high output.  
 Calibration is accurate to .1%.

Special Bliley 40 meter crystal holders. . . . . \$ .95

TAYLOR T20 AND TZ20 . . . . .	\$2.45
TAYLOR T125 . . . . .	13.50
TAYLOR 203Z . . . . .	8.50
EIMAC 100TH . . . . .	13.50
EIMAC 250TH . . . . .	24.50
RAYTHEON RK39 . . . . .	3.50
AMPEREX HF100 . . . . .	12.50

We usually have some receivers on hand that have been  
 taken in trade on new sets. If you are looking for a used  
 job it might pay you to see us.

W3AHR

MAIL ORDERS PROMPTLY FILLED

W3BMS

**CONSOLIDATED RADIO CORP., 612 Arch St., Philadelphia, Pa.**

# JUST ONE YEAR IN BUSINESS

*Already a Leader in the Field*

# THERE MUST BE A REASON

. . . . .

## *Terminal Radio Corporation*

80 CORTLANDT STREET, NEW YORK CITY

Bill Filler



Adolph Gross

# DO YOU WANT TO LEARN WIRELESS and TELEGRAPHY?



TWO BOOKS EVERY AMATEUR  
SHOULD HAVE —

*Send Now!*

**10¢  
Each**  
POSTPAID  
COIN, OR  
STAMPS

Hundreds of ama-  
teurs have learned  
from these books, so  
can you.

These books give you the fundamentals of  
wireless and telegraphy. They contain the codes  
and how to learn them. Mail your order now to:

**SIGNAL ELECTRIC MFG. CO., Menominee, Michigan**

ESTABLISHED  
1892

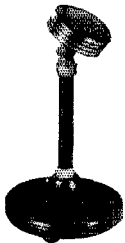

## VT-73

Get broadcast quality reports with  
the VT-73. It's high level. Accept-  
ed by Hams the world over.

**LIST — \$25.25**

Licensed under patents of the Brush  
Development Company

**THE TURNER CO.**  
CEDAR RAPIDS, IOWA

## 1938 Catalog Ready

HAVE YOU OBTAINED YOUR COPY?

In it are complete illustrations of our new  
L and V series mountings, also our new type CBC  
commercial unit.

We have made several improvements on our  
popular amateur unit, type VM2 mounted  
crystal for the 160, 80, and 40 meter bands. No  
increase in price — \$3.00.

Our new low drift type LMA mounted crystal  
160, 80 and 40 meters, a unit of commercial  
design for amateur use. ONLY \$4.50.

Obtain a copy from your local dealer or write direct

THE VALPEY CRYSTALS  
P.O. Box 321, Highland St., Holliston, Mass.

met by the values specified when the speech  
amplifier tubes are triodes, as shown in the circuit  
diagram.—Editor.

## I. A. R. U. News

(Continued from page 44)

- Roumania: Victor Cantuniari, Str. Matei Basarab, 3 bis  
Bucaresti IV.
- Salvador: J. Frederico Mejia, 7a Calle Poniente 78, San  
Salvador City.
- South Africa: S.A.R.R.L., P. O. Box 7028, Johannesburg.
- Southern Rhodesia: see South Africa.
- Spain: U.R.E., Apartado 282, Madrid.
- Sudan: c/o Frank H. Pettitt, Catholic Club, Mustapha  
Barracks, Alexandria.
- Sweden: S.S.A., Stockholm 8.
- Switzerland: U.S.K.A. Neu Allschwil near Basle.
- Tanganyika: see Kenya.
- Trinidad: see Antigua.
- Uganda: see Kenya.
- Uruguay: U.S.W.C.G., Box 37, Montevideo.
- U.S.S.R.: C.B.S.K.W., I Samoteahny, 17, Moscow.
- Venezuela: R.C.V., Torre a Madrices No. 8, Caracas

## Strays

Somebody must have been reading a book.  
W9PLF discovered in a local paper an ad for a  
ceiling fan which runs on up-and-down current!

And another paper, in a biographical sketch of  
Marconi, goes on to relate how many lives were  
"saved by prompt response to the old distress  
signal PDQ"! Spotted by W3BCI.

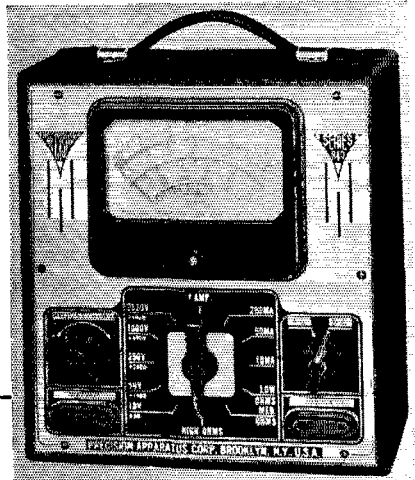

## New "PRECISION" Series 840L

A.C.—D.C. VOLT—OHM—DECIBEL—MILLIAMMETER

including a 2500 volt A.C.—D.C. range

- ★ 5 A.C.—D.C. Voltage Ranges from 0 to 2500 volts.
- ★ 3 Resistance Ranges from 0 to 10 meg. (provision for self-contained batteries).
- ★ 4 D.C. Current Ranges from 0 to 1 amp.
- ★ 5 Decibel Ranges from -10 to +63 DB.
- ★ 5 Output Ranges.

Net Price to Amateurs **\$19.95** Less Batteries and Test Leads

**PRECISION APPARATUS CORP.**  
821 EAST NEW YORK AVE., BROOKLYN, NEW YORK



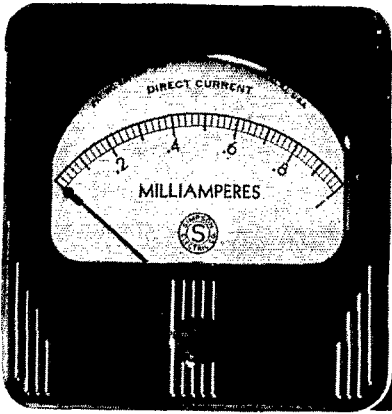

# They're TAKING THE FIELD BY STORM!

— and no wonder!

UNTIL this remarkable series of meters was announced, panel instruments were a real "headache" to most amateurs. There was either the headache of paying a premium price for an accurate, durable instrument, or the even worse headache of trying to "get by" with short-lived instruments of questionable accuracy. Then suddenly the big news went out: "You can buy panel instruments with the costly bridge-type construction and soft iron pole pieces at the price you have been paying for the ordinary run of instruments!"

Think of it!

**ILLUMINATED DIAL** A translucent dial with evenly diffused illumination provided by built-in 6 volt lamp in a stream-line 3 x 3 1/8" case of exquisite artistry and finish. Also the expensive **BRIDGE-TYPE CONSTRUCTION** and soft iron pole pieces that mean **LASTING ACCURACY**.

Net price to amateurs of most A. C. and D. C. ranges including lamp and socket..... **\$5.24**

Thermo-couple types of same ranges including lamp and socket..... **\$8.18**

The instrument above mounts in a round, 2 3/4" diameter hole. Round case, non-illuminated instruments with identical movement are available in most A.C. and D.C. ranges at net price of \$4.15—Thermo-couple types, net \$7.70.

Good news travels fast—and that's why more and more ham stations are being equipped with these Simpson instruments. An unsurpassed experience in instrument building aided by modern production methods have made this almost incredible value possible. A typical example of the remarkable value found throughout the line is illustrated opposite. See this and other Simpson meters and testing equipment at your jobber's. Why accept less than Simpson quality, beauty and accuracy, when it costs no more to have it! Coupon brings facts.

**SIMPSON ELECTRIC CO.**  
5216 W. Kinzie Street, Chicago

## Mail This Coupon For Facts

Simpson Electric Co., 5216 W. Kinzie St., Chicago

Send facts about Simpson Instruments.

Name \_\_\_\_\_ Call \_\_\_\_\_

Address \_\_\_\_\_

# SIMPSON

*Instruments that STAY accurate*

## R. R. Jobs for CW MEN

65 TO 80c PER HOUR. YEAR AROUND

R. R. Pension Making Hundreds of Vacancies. Learn Train Traffic System and Morse Through our Course and Quality for Job in 4 Months. Time Payments if Desired. Ages 18 to 35.

**CODE-CRAFT** CLEVELAND, OHIO  
6703-Q Dunham Ave.

## ORIGINAL W8UD CLASS B

UNIVERSAL TRANSFORMERS—Now Improved  
MATCH ALL TUBES

50 WATTS AUDIO, PER PAIR : : \$4.95 + POST  
100 WATTS AUDIO, PER PAIR : : 7.75 + PAID  
ONE YEAR GUARANTEE—Write for Data Sheets

Now Sold Exclusively By  
C. R. MALMGREN, W9IXR, WEYERHAEUSER, WIS.

## Douglas Radio Products

Radio Operator's  
Course  
Telegraphy—  
Telephony  
Aviation



Practical  
Experience  
Studio—  
Transmitter—  
Announcing

PORT ARTHUR COLLEGE has been teaching Radio for twenty-eight years, and during this time it has never been our policy to guarantee positions to prospective students, directly or indirectly. We believe it wisdom at this time, however, to go on record in our QST advertising to say that it is impossible for us to even come near to supplying the demand for Radio Operators received by our Employment Department. We do not mean by this that all students who enroll will automatically secure positions. The demand is for graduates — good men who deserve and are qualified to hold positions. The graduates of our Radio School, so far as we know or can learn, are employed 100%.

It is possible for every student who enters the P. A. C. Radio School and completes the course in keeping with our standards to receive employment as a Radio Operator for our station

K P A C at the transmitter, in the control room, as trans-radio press operator, or announcer, and not only earn more money than he pays for the training but to also continue his training as a post-graduate student in advanced work and prepare himself to secure and hold operating positions in the upper bracket of broadcasting, marine work, announcing, or airways.

Port Arthur College advertises primarily to Radio Amateurs, and the training is too technical for the average student who has not selected Radio as his life's work. We know the opportunities for positions and advancement are unlimited for men who are interested in Radio and who plan to make this their career and are willing to make the sacrifice and effort necessary to master our training. P. A. C. maintains strict collegiate rank — only high school or college graduates are eligible for enrollment.

If interested in details about Radio Course, write for bulletin R

**PORT ARTHUR COLLEGE** ■ **PORT ARTHUR (World-known port) TEXAS**

# Where to buy it

A directory of suppliers who carry in stock the products of these dependable manufacturers.



**ALBANY, N. Y.** Uncle Dave's Radio Shack 356 Broadway

**BALTIMORE, MD.** Radio Electric Service Company 3 North Howard St.

**BOSTON, MASS.** Radio Shack 46 Brattle Street

**NEWARK, N. J.** Wholesale Radio Service Co., Inc. 219 Central Ave.

**NEW YORK, N. Y.** Gross Radio, Inc. 51 Vesey St.

**NEW YORK, N. Y.** Harrison Radio Co. 12 West Broadway

**NEW YORK, N. Y.** Wholesale Radio Service Co., Inc. 100 Sixth Ave.

**NEW YORK, N. Y.** Terminal Radio Corp. 80 Cortlandt Street

**POTTSVILLE, PENN.** E. Norwegian & George Sts. Sylvester Radio & Supply Co., Inc.

**READING, PENN.** George D. Barbey Company 404 Walnut St.

**READING, PENN.** Sylvester Radio & Supply Co., Inc. 104 North Ninth Street

**SPRINGFIELD, MASS.** T. F. Cushing 349 Worthington St.

**WASHINGTON, D. C.** Sun Radio & Service Supply Co. 938 F Street, N. W.



**ALBANY, N. Y.** Uncle Dave's Radio Shack 356 Broadway

**BALTIMORE, MD.** Radio Electric Service Company 3 North Howard St.

**BOSTON, MASS.** H. Jappe Company 46 Cornhill

**BOSTON, MASS.** Radio Shack 46 Brattle Street

**BURLINGTON, VERMONT** Vermont Hardware Co., Inc.

**GREENWICH, CONN.** Mead Stationery Company 252 Greenwich Ave.

**MONTREAL, CANADA** Canadian Electrical Supply Co., Ltd. 285 Craig Street, West

**NEWARK, N. J.** Wholesale Radio Service Co. 219 Central Avenue

**NEW YORK, N. Y.** Bruno-New York, Inc. 460 W. 34th St.

**NEW YORK, N. Y.** Sanford Samuel Corp. 136 Liberty St.

**NEW YORK, N. Y.** Wholesale Radio Service Co. 100 Sixth Avenue

**NEW YORK, N. Y.** Harrison Radio Company 12 West Broadway

**NEW YORK, N. Y.** Grand Central Radio, Inc. 124 E. 44th Street

**PHILADELPHIA, PENN.** Eugene G. Wile 10 S. 10th Street

**PHILADELPHIA, PENN.** Raymond Rosen & Company 117 North 7th St.

**PHILADELPHIA, PENN.** M & H Sporting Goods Company 512 Market Street

**POTTSVILLE, PENN.** E. Norwegian & George Sts. Sylvester Radio & Supply Co., Inc.

**READING, PENN.** Bright & Company 8th & Elm Streets

**READING, PENN.** Sylvester Radio & Supply Co., Inc. 104 North Ninth Street

**SPRINGFIELD, MASS.** T. F. Cushing 349 Worthington Street

# Where to buy it

A directory of suppliers who carry in stock the products of these dependable manufacturers.

WASHINGTON, D. C. 938 F Street, N. W.  
Sun Radio & Service Supply Co.

BUFFALO, NEW YORK 326 Elm Street  
Radio Equipment Corp.

CONCORD, NEW HAMPSHIRE 80 N. State Street  
Carl B. Evans

NEWARK, NEW JERSEY 219 Central Street  
Wholesale Radio Service Co.

NEW YORK, N. Y. 12 West Broadway  
Harrison Radio Company

NEW YORK, N. Y. 100 Sixth Avenue  
Wholesale Radio Service Co.

WASHINGTON, D. C. 938 F Street, N. W.  
Sun Radio & Service Supply Co.

**RME**  
RECEIVERS -- PRE SELECTORS  
AMATEUR RADIO EQUIPMENT  
RADIO MFG. ENGINEERS, Inc.  
PEORIA ILLINOIS

ALBANY, NEW YORK 356 Broadway  
Uncle Dave's Radio Shack

BINGHAMTON, NEW YORK 25-27 Sturges Street  
Radio Testing Station

BUFFALO, NEW YORK 216 E. Genessee Street  
Dymac Radio

HARTFORD, CONNECTICUT 210 Chapel Street  
Stern Wholesale Parts Company

NEW YORK, N. Y. 12 West Broadway  
Harrison Radio Company

NEW YORK, N. Y. 80 Cortlandt Street  
Terminal Radio Corp.

ROCHESTER, NEW YORK 244 Clinton Ave., N.  
Radio Parts & Equipment Co.

**TRIPLET**  
INSTRUMENTS

ALBANY, N. Y. 356 Broadway  
Uncle Dave's Radio Shack

BOSTON, MASS. 46 Brattle Street  
Radio Shack

BOSTON, MASS. 28 Brattle St.  
Selden Radio Company

MONTREAL, CANADA 285 Craig Street, West  
Canadian Electrical Supply Co., Ltd

NEWARK, N. J. 219 Central Ave.  
Wholesale Radio Service Company

NEW YORK, N. Y. 100 Sixth Avenue  
Wholesale Radio Service Company

POTTSVILLE, PENN. E. Norwegian & George Sts.  
Sylvester Radio & Supply Co., Inc.

READING, PENN. 404 Walnut Street  
George D. Barbey Company

READING, PENN. 104 North Ninth St.  
Sylvester Radio & Supply Co., Inc.

WASHINGTON, D. C. 938 F Street, N. W.  
Sun Radio & Service Supply Co.

**RAYTHEON**  
TRADE MARK  
AMATEUR TUBES

ALBANY, NEW YORK 356 Broadway  
Uncle Dave's Radio Shack

BOSTON, MASS. 46 Brattle Street  
The Radio Shack

BOSTON, MASS. 28 Brattle Street  
Selden Radio Company

# HAVE YOU MET THE *Coto* INDUCTOR FAMILY?

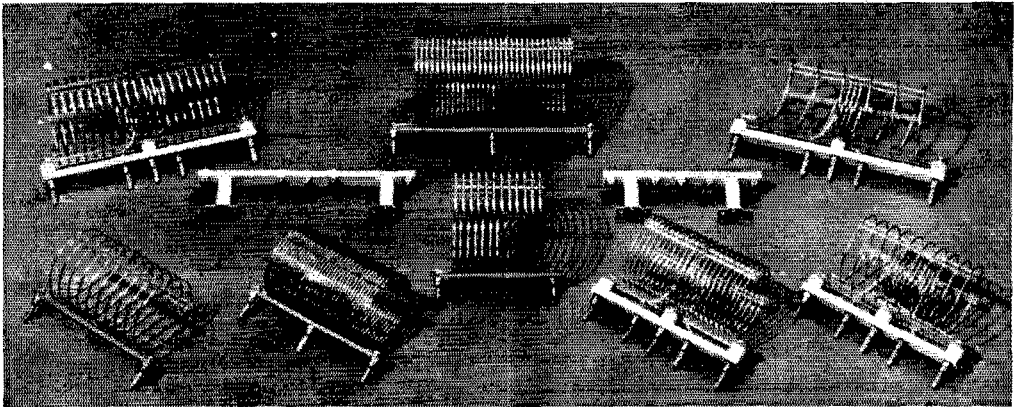

## ❖ TO KNOW THEM IS TO USE THEM ❖

If you plan to build a new rig, remodel your present one or if you are just window shopping, by all means meet the COTO inductor family at your jobber.

Their high 'Q' and operating efficiency, plus plug-in convenience, provide you with modern inductor design, surprisingly low in cost.

There are more than 25,000 COTO inductors in use today, giving satisfactory service. They must be \*superior! Ask the Hams who use them, they know!

\* 1st to use { Alsimag 106 material!  
Non-Celluloid supports!  
An integral variable link!

Visit Our  
Booth No. 206

RADIO



PRODUCTS

N. Y. Parts Show  
Oct. 1, 2, 3

## COTO-COIL COMPANY, Inc.

229 Chapman St., Providence, R. I.

Export Address: 100 Varick St., N. Y. C.

**LOW PRICED! EASY TO ERECT!**  
**STEEL ANTENNA TOWER**

HAMS!—Here's the ideal antenna tower—can also be used as a vertical radiator. Strong! Light weight! Extremely rigid! Comes in 20 ft. sections, with 5 ft. tip, knocked down, for building towers 25, 45, 65, 85, or 105 ft. high, as you wish. Easy to erect. Easy to climb.

**Tower Legs**— $\frac{1}{2}$ " x  $1\frac{1}{4}$ " x  $1\frac{1}{4}$ " x 20 ft. Low carbon rail steel angle. Galvanized after fabrication.

**Cross Bars**— $\frac{1}{2}$ " x  $\frac{3}{4}$ " x  $12\frac{1}{2}$ " mild steel, spot welded to form X brace. Baked black enamel.

**Bolts**— $\frac{1}{4}$ " USS x  $\frac{3}{4}$ "—1035 steel, cadmium plated. **Guy Wire**—300 ft. No. 9 galvanized with each 20 ft. section. Tower weighs  $4\frac{1}{2}$  lbs. per foot when assembled.

Order Direct From  
**WINCHARGER CORPORATION**  
Dept. QST-10      Sioux City, Iowa

**60<sup>c</sup>** FT.  
i. e. D. Sioux City, Iowa

**LEARN CODE RIGHT**  
Tapes for Every Need — Even Airways  
— Send You Typical Messages by  
**INSTRUCTOGRAPH**

It's easy and practical to learn or improve your Radio or Morse Code, any speed. Senior model with 10 tapes and Book of Instructions — \$20.25 (Rented at low cost) Junior model with 5 tapes and Book of Instructions — \$12.00. (Not rented). Complete oscillator equipment, less battery, \$6.50. Write for details today.

INSTRUCTOGRAPH CO. Dept. Q-10  
912 Lakeside Place Chicago, Ill.  
Radio College of Canada  
863 Bay St., Toronto

BUY ON CASH OR TERMS: HALLIGRAFTER AND R. M. E. SHORT WAVE RECEIVERS, SPEED-X AND VIBRO- PLEXES, Telegraph Instruments and Hand Books.

**MIMS**  
**SIGNAL SQUIRTER**  
ROTARY BEAM ANTENNAS  
20 and 10 Meters Only

W5FHJ  
Henry  
Hart,  
Ruleville,  
Miss.  
WAC on  
Phone  
in 4 days  
with  
Signal  
Squitter

Why  
not  
you  
too  
?

Signal Squirters are fun. Ask Henry Hart — better still — see for yourself. Ask for QRA of one nearest you and make a visit — you'll be glad you did.

**"Put Your Signal Where You Want It When You Want It There"**

Write for Bulletin SS2

## MIMS RADIO COMPANY

M. P. MIMS — W5BDB, P. O. Box 504, Texarkana, Ark.

# HAM-ADS

(1) Advertising shall pertain to radio and shall be of nature of interest to radio amateurs or experimenters in their pursuit of the art.

(2) No display of any character will be accepted, nor can any special typographical arrangement, such as all or part capital letters be used which would tend to make one advertisement stand out from the others.

(3) The Ham-Ad rate is 15c per word, except as noted in paragraph (6) below.

(4) Remittance in full must accompany copy. No cash or contract discount or agency commission will be allowed.

(5) Closing date for Ham-Ads is the 25th of the second month preceding publication date.

(6) A special rate of 7c per word will apply to advertising which, in our judgment, is obviously non-commercial in nature and is placed and signed by a member of the American Radio Relay League. Thus, advertising of bona fide surplus equipment owned, used and for sale by an individual or apparatus offered for exchange or advertising inquiring for special equipment, if by a member of the American Radio Relay League takes the 7c rate. An attempt to deal in apparatus in quantity for profit, even if by an individual, is commercial and takes the 15c rate. Provisions of paragraphs (1), (2), (4) and (5) apply to all advertising in this column regardless of which rate may apply.

Having made no investigation of the advertisers in the classified columns, the publishers of *QST* are unable to vouch for their integrity or for the grade or character of the products advertised.

**QUARTZ**—direct importers from Brazil of best quality pure quartz suitable for making piezo-electric crystals. Diamond Drill Carbon Co., 719 World Bldg., New York City.

**RADIO** engineering, broadcasting, aviation and police radio, servicing, marine and Morse telegraphy taught thoroughly. All expenses low. Catalog free. Dodge's Institute, Byrd St., Valparaiso, Ind.

**QSL'S, W2SN, Helmetta, N. J.**

**CALLBOOKS**—new DX calls, new prefixes, thousands of new W and VE calls, in the Fall, 1937 Radio Amateur Call Book. Sent postpaid \$1.25, or a whole year (four issues) for \$4. (In foreign countries \$1.35 and \$4.35.) Your call and QRA printed in large type \$1 per year. Radio Amateur Call Book, 610 S. Dearborn, Chicago.

**QSL'S**, all colors, cartoons, snappy service. Write for free samples today. W1BEF, 16 Stockbridge Ave., Lowell, Mass.

**COMPLETE** training for all amateur and professional radio licenses. New York Wireless School, 1123 Broadway, N. Y.

**QSL'S**—Entirely new printing process makes more beautiful cards at lower cost—Send 10¢ in stamps for elaborate kit with which you can design your own card—Astomishingly inexpensive. QSL Company, Box 481, Hartford, Conn.

**USED** receivers. Bargains. Price list 3¢. W3DQ, 405 Delaware Ave., Wilmington, Del.

**BARGAINS**, crystals, tubes, etc. Hickok test equipment. Canady, 38 W. Anderson, Aurora, Mo.

**CENTRAL** Illinois hams—RME equipment. See, write W9ARN.

**BLILEY** crystals. Patronize W8DED.

**JOHNSON Q'S**, condensers. Write W8DED.

**QSL'S, QSL'S**. No cheap trashy stuff. Samples? W8DED, Holland, Mich.

**FOR** sale: Kilowatt transmitter complete. Four power supplies. Eleven Weston meters. 861 final amplifiers. \$250. W3GUZ.

**SELLING** out. Complete station 600 to 800 watt c.w. rig completely enclosed rack. HRO, Vibroplex, crystals, tubes, all in new condition. W2JOZ.

**HAMS**—SWL's—20" x 12" wood identification sign with your call letters. Your color combination. \$3. plus postage. Herb's Radio, Kingfield, Me.

50 watt Webster amplifier, 3 stages, final 845's, ideal modulator. Take best cash offer or trade public address equipment. Write for public address bargains. Platten Radio Co., Green Bay, Wis.

**QSL'S**. Cartoons. Free samples. Theodore Porcher, 7708 Navajo St., Philadelphia, Pa.

**WESTERN** Electric amplifiers 8A, \$25; 9A, \$15; complete A rectifier 42A, \$30; three meter panel, \$5. W2ECR, 853 53 St., Brooklyn, N. Y.

**DYNAMOTOR** 6/400 v., \$12; 32/300 v., \$7 or trade for a.c. equipment. VE4LY, Lipton, Sask.

**SELL** Carter 12/500 volt 150 mill ball bearing genemotor, \$15. Clarence A. Baum, Petersburg, Ill.

**FIRST \$65** takes swell FBXA 10, 20, 40, 80 bandspread, broadcast coil, speaker, power supply, new tubes with 2 stage postal preselector with 10 & 20 coils. Over 100 countries heard February, March—Asia almost daily through N. Y. C. QRM. W2BNX.

**SALE:** Three c.w. xmitters 50, 200, 250 watts in. Two homemade ham supers. #13 scope. Two MG's. Consider part trade. Foto and details for stamp if you mean business. W8BQ.

1000 watt transformers (G.E.) on marble bases 1100—2200—4400 each side center. Hundreds sold hams last eleven years—guaranteed unconditionally. Dawson, 5740 Woodrow, Detroit, Mich.

**STAMP** for list of used ham equipment. W8GWA.

**HEAR** ur sigs on phono records as recvd hr. Write for schedule, \$50. Phone stations. Have a professional announcement of your call recorded c.g. or testing records, \$50. Brown's Radio Lab., Dolgeville, N. Y.

**BUY**, sell, trade used parts and receivers. 150 watt, 110 volt a.c. generator, \$6.50. Brown's Radio Lab., Dolgeville, N. Y.

**FOR** sale. Complete—full coverage coils 10 meters to 120, \$25 cash—30 volt 50 amp. generator. Sell or swap for 110 volt a.c. generator. W1HRE.

**SELL:** complete 160 fone xmitter, 59's final. PP45 c.w. xmitter complete. RCA ACR-136 receiver, \$45. W2CIZ.

**WANT:** 20 to 160 meter fone, c.w. xmitter 100 watts. Candid camera. W2CIZ.

**FOR** sale—Janette rotary converter, 32 v. d.c. to 110 v. a.c. 300 watt with filter. Used about 5 hours, cost \$44.25. First \$22 takes it. W8ZO. Ypsilanti, Mich.

**YOUR** dealer should have them or order direct, 160 or 80 meter crystals, 75¢. Faberadio, Sandwich, Ill.

**SELL** beginner's station complete, highest quality parts, \$80. Write Joseph Rando, 663 Crescent Ave., N. Y. C.

**TRADE** 5 x 7 Aerial camera F.5 lens Graflex Film Magazine for RME-69 or sell \$125. Foto 5¢. Also Filmo 70 DA and case \$175. Royce, Vineland, N. J.

**SILVER** Masterpiece three four, both complete. Want Briggs similar engine. Glenn Watt, Chanute, Kansas.

**SLIGHTLY** used RCA, Philco, Stromberg, etc., radios. 1934 to 1937 sets in perfect condition—\$4. to \$8. Special discounts for repeat orders. W2ERI, Arnold Resnik, 1873 Andrews Ave., Bronx, N. Y.

**STORAGE** B battery, 1200 volts, Exide 6 ampere hour size, in good condition, \$25. Two 212D Western Electric tubes, emission good, postpaid, \$5 each. W9BSP, Olathe, Kansas.

**RCA** ACT20 transmitter and coils, five bands. A bargain. Mims Radio Co., Texarkana, Ark.

**NEWEST** QSL's, SWL's. Really different. Fritz, 203 Mason, Joliet, Ill.

**MICROPHONES:** W.E. and RCA condenser type with amplifier, cord, and plugs, A-1 condition, \$10. W9AFA, Downers Grove, Ill.

**QSL's**, 300 one-color cards, \$1. Samples. 2143 Indiana Ave., Columbus, Ohio.

**TRANSFORMERS**, chokes made to your order. All sizes up to 3 kilowatt. Write for list, reasonable Prices. Baker Engineering, Ft. Wayne, Ind.

**QSL'S**. Finest quality. Lowest prices. Samples. Maleco, 1512 Eastern Parkway, Brooklyn, N. Y.

**W2CNL** selling out.

**QSL'S**. Free samples. Printer, Corwith, Iowa.

**WANTED:** Instructograph American Morse wire code tapes. W6MGC, 2901 Yu St., Sacramento, Cal.

**CRYSTALS**, ground to order, 160—80, X cut, = five kilocycles, \$1.50. Spot frequency, \$2.50. Speedy delivery. William Threm, W8FN, 4201 Davis Ave., Cheviot, Ohio.

**CRYSTALS:** 1" square X cut 80—160 meters, \$1.40; mounted, 2.25. 40 meters, \$2.50; mounted, \$3.25. Within 3 k.c. of desired frequency. Guaranteed the very best. The Ransom Lab., N. Syracuse, N. Y.

**SELL** or swap—849, 204A, pair 600 mil output 866A's, four tantalum 852's. All guaranteed. SW3 with coils & power supply. Reconditioned WE387 carbon mike. All priced for quick disposal. W9HYO, Chicago.

**ARTISTIC** QSL's. T. Vachovetz, Elmsford, N. Y.

**GET** an R9 crystal in our new air gap holder near your frequency in the 80 and 160 meter bands, \$1.25. R9 Crystals, 338 Murray Ave., Arnold, Pa.

**QSL'S**—2 color—\$1. hundred. Samples. Stamp. W8NOS.

**WANTED:** Candler advanced course. Pay cash. W5GEA.

**SOCKET** hole Punch 1 1/2" diameter. Postpaid \$1. in U. S. Stoughton Mfg. Co., Oak St., Portland, Me.

**WANTED:** 2000 v. 500 ma. power supply complete 25 cycle. VE3ADV, Simcoe, Ont.

**SELL** 300 watt c.w. xmitter, consistently R7 in Europe. Standard parts. T155 final, \$125. Also factory built grid modulator with Astatic mike for \$25. H. E. Harrison, Brookings, S. Dakota.

USED Dumont oscilloscope, 5" tube, \$55; new double button mike, \$5.40; Kennedy receiver, \$20; Vibroplex key, \$6.50; New 838, \$11. Send for list. Mae L. Trautman, 35 Ellis Ave., Irvington, N. J.

QSL'S. Highest quality. Lowest prices. Radio Headquarters, Ft. Wayne, Ind.

RECEIVER: RCA ACR-175 used only eight months, \$72. W2CSY.

QSL'S. SWL's, 100 3 color, 75¢. Lapco, 344 W. 39th, Indianapolis, Ind.

GENUINE EO-1 Cable, by Graham, manufactured by General Cable Corp., sold by W8DT. QSL card for data.

SELL 400 back issues QST. W8DT.

VERTICAL radiators: 2 galvanized steel angle radio broadcast towers. 13 ft. sq. at base, 2 ft. sq. at top, 100 ft. high. Excellent radiators for amateur or police wave lengths. Write for picture. \$300 each f.o.b. Tacoma. George Wayne, 1001 E. D St., Tacoma, Wash.

CRYSTALS: Eidson T9 fracture resisting 40 and 80 meters. \$1.60 postpaid. Dependable, powerful. Genuine X cut. Fully guaranteed. Complete stock maintained. The safest and best route to ten meters and ten's just around the corner. T9 ceramic plug-in holders, \$1.10 postpaid. C.O.D.'s accepted. Eidson's Temple, Texas or Hieronymus Radio, 38-34 209th St., Queens Village, N. Y.

RADIO materials. Bankrupt jobber stock. Everything service-men, Hams use. Quality Radio, Richmond, Ind.

CRYSTALS: X cut; 80M, \$1.50, V cut; 160M, \$2.50; 80M, \$2.25; 40M, \$3. Unconditionally guaranteed. Holders, \$1. Catalog. Ham Crystals, 1104 Lincoln Place, Brooklyn, New York.

MOST convenient terms ever offered: Buy Hallicrafters, RME, RCA receivers, all types, by exchanging good used equipment as substantial down payment, balance on long monthly terms. Write us today. Radio Apparatus Exchange, W9PR, 704 Francis St., St. Joseph, Mo.

QSL'S of distinction. W2AEY, 338 Elmora, Elizabeth, N. J.

RCA tungar supply; 12 volts, 15 amps. rack mounting; complete \$30; W2JDF, Box 3 Sheepshead Bay P. O., Brooklyn, N. Y.

GENERATORS 110 v. a.c. 500 watt, \$20; 700 watt \$30. Want PR-16 cabinet. Leo Larkin, NDP, Federal Bldg., Sioux City, Iowa.

NEW 204A \$19; used \$49's \$10; Nat'l SW recr. coils, pwr unit, complete \$18; Salter, 127 N. 16, E. Orange, N. J.

TELEPLEXES, instructographs, omniographs, vibroplexes, bought, sold, Ryan's, Monroe City, Mo.

CUSTOM wound precision resistors to your specifications. Voltmeter resistors and ammeter shunts. Dual Engineers, 7621 So. Park, Chicago.

8000 v. G.E. transformers. Few left at \$20, 4.25KVA—Choice 110 v. 220 v. types. Builtin primary switch reduces R.A.C. from 4000 to 2000 v. in 8 steps. Write details. W1BES, 143 Eastwood Ave., Providence, R. I.

NEW. Write for circulars describing new economical transmitter kits with inputs varying from 25 to 1000 watts, at prices you can afford to pay. Please state your requirements. W8ANT.

Receiver headquarters. W8ANT.

RME-69's and DB 20's in stock. W8ANT.

1938 Super Skyriders in stock. W8ANT.

USED receivers. W8ANT.

NEW and used transmitting tubes. W8ANT.

USED microphones. W8ANT.

ALL lines of new and used amateur equipment bought, sold, exchanged. Write to Southern Ohio's only amateur owned amateur business. Jos. N. Davies, W8ANT, 2767 N. Bend Rd., Sta. A., Cincinnati, Ohio.

BUY any new receiver, transmitter, or parts on my own 6% installment plan with less interest cost. Trade in your equipment. All receivers shipped on trial. Your inquiries invited. Bob Henry, W9ARA, Butler, Mo.

WHEN buying a receiver whether you pay cash, trade in your receiver, or buy on terms, it's to your advantage to see my ads on other pages of this issue of QST. Bob Henry, W9ARA, Butler, Mo.

SELL: NC100's \$89, SX11's \$60, ACR-175's \$69, relay rack RME9D's \$64, AVC Comet Pros \$57.50, SX9's \$54, Crystal Super Skyriders \$34, Super-Sevens \$29, FB7's \$19, latest ACSW3's \$12.50, other sets. List free. Bob Henry, W9ARA, Butler, Mo.

SELL: Complete station ready to operate. Transmitter in W.E. rack-cracked alum.—Output 300 w. c.w.—100 w. phone. Speech amplifier and receiver in table rack. Shure xtal mike—xtals—tubes, \$200. Ex-10MP, C. H. Jackson, U. S. Airway Experimental Sta., Anacostia, D. C.

*In the EAST it's*

# DELAWARE RADIO SALES

Immediate delivery on all standard  
receivers and transmitters

LOW DOWN PAYMENTS ARE AS FOLLOWS:

National 80-X or 81-X .....	\$5.00
NC-100 .....	6.88
NC-101X .....	7.38
HRO .....	9.88
RME-69 .....	7.38
1938 Super Skyrider .....	5.50
Patterson PR-15 .....	6.25
Breting 14 .....	6.13
RCA ACR-155 .....	4.13
RCA ACR-175 .....	6.58
RCA ACR-111 .....	10.50
Super Pro .....	13.38

SPECIAL TERMS ON TUBE AND  
PARTS ORDERS

*Send 3¢ for complete details*

## DELAWARE RADIO SALES COMPANY

WILLARD S. WILSON—W3DQ

*Established 1920*

405 Delaware Avenue

Wilmington

Delaware

# Your Nearest Dealer Is Your Best Friend

Your nearest dealer is entitled to your patronage. You can trust him. He is equipped with a knowledge and understanding of amateur radio. He is your logical and safe source of advice and counsel on what equipment you should buy. His stock is complete. He can supply your needs without delay. His prices are fair and consistent with the high quality of the goods he carries. He is responsible to you and interested in you.

Patronize the dealer nearest you—You can have confidence in him

## ATLANTA, GEORGIA

Wholesale Radio Service Company, Inc.  
430 West Peachtree Street, N. W.  
"Investigate Our Easy Payment Plan"

## NEW YORK, N. Y.

Wholesale Radio Service Company, Inc.  
100 Sixth Avenue  
"Investigate Our Easy Payment Plan"

## BALTIMORE, MARYLAND

Radio Electric Service Co.  
3 N. Howard St.  
Everything for the amateur

## NEW YORK, N. Y.

Harrison Radio Company  
12 West Broadway  
"The Friendly Ham Supply House"

## BOSTON, MASS.

Wholesale Radio Service Company, Inc.  
110 Federal Street  
"Investigate Our Easy Time Payment Plan"

## PHILADELPHIA, PENNSYLVANIA

Eugene G. Wile  
10 S. Tenth Street

Complete Stock of Quality Merchandise

## BRONX, NEW YORK

Wholesale Radio Service Company, Inc.  
542 East Fordham Road  
"Investigate Our Easy Payment Plan"

## BUFFALO, NEW YORK

Radio Equipment Corp.  
326 Elm Street  
W80BK — Ham, service and sound equipment — W80LB

## PROVIDENCE, RHODE ISLAND

W. H. Edwards Co.  
32 Broadway  
National, Taylor Tubes, Hallicrafters. Complete amateur supply house

## BUFFALO, NEW YORK

Dymac Radio  
216 E. Genesee Street  
Complete Line Ham and BCL Equipment Cl. 2080

## PROVIDENCE, RHODE ISLAND

Kraus & Company  
89 Broadway  
Everything for the amateur and serviceman

## JAMAICA, L. I.

Wholesale Radio Service Company, Inc.  
90-08 166th Street (Merrick Road)  
"Investigate Our Easy Payment Plan"

## RICHMOND, VIRGINIA

The Arnold Company  
527 W. Broad Street  
W3EHL—"The Virginia Ham Headquarters"—W3FBL

## MONTREAL, CANADA

Canadian Elec. Supply Co., Ltd.  
285 Craig St., W.  
Quality parts and equipment for discriminating buyers

## ROCHESTER, NEW YORK

Radio Parts & Equipment Co.  
244 Clinton Avenue, North  
Complete stock amateur-BCL parts. Standard discounts

## NEWARK, N. J.

Wholesale Radio Service Company, Inc.  
219 Central Avenue  
"Investigate Our Easy Payment Plan"

## SYRACUSE, NEW YORK

Roy C. Stage, W8IGF  
Complete stock of standard Ham & BCL parts  
Standard Discounts. Free technical service

## NEW YORK, N. Y.

Gross Radio, Inc.  
51 Vesey Street  
Fair dealings plus fair prices. Anything in radio

## SPRINGFIELD, MASS.

S. S. Kresge Company  
1540 Main Street  
Standard discounts, standard lines. Advisory service: W1JQ, W1FOF

# You Are Protected When You Buy From QST Advertisers

“Advertising for QST is accepted only from firms who, in the publisher’s opinion, are of established integrity and whose products secure the approval of the technical staff of the American Radio Relay League.”

Quoted from QST’s advertising rate card.

Every conceivable need of a radio amateur can be supplied by the advertisers in QST. And you will know the product has the approval of the League’s technical staff.

## The Advertisers

Aerovox Corporation.....	page 107
Aladdin Radio Industries, Inc.....	94
American Communications Company.....	97
Ampere Electronic Products.....	65
Astatic Microphone Laboratory.....	90
Atkins & Brown.....	98
Barker & Williamson.....	92
Bellefonte Radio Eng. & Mfg. Co., Inc.....	110
Bendix Radio Corporation.....	67
Birnback Radio Company.....	92
Billy Electric Company.....	58, 103
Brach Mfg. Company, L. S.....	94
Burgess Battery Company.....	56
Burton-Rogers Company.....	99
Candler System Company.....	103
Capitol Radio Engineering Institute.....	114
Cardwell Mfg. Corporation, Allen D.....	64
Centralab.....	71
Chicago Radio Apparatus Company.....	87
Code-Craft.....	119
Colson's Sons, Ltd., I. S.....	113
Collins Radio Company.....	Cov. 2
Consolidated Radio Corporation.....	117
Cornell-Dubilier Corporation.....	96
Coto-Coil Company, Inc.....	122
Delaware Radio Sales Company.....	124
Delco-Remy Corporation.....	69
Dodge's Institute.....	107
Douglas Radio Products.....	119
Eastern Radio Institute.....	114
Etzel-McCullough, Inc.....	73
Electro-Voice Mfg. Company.....	115
Gardiner-Levering Company.....	102
General Transformer Corporation.....	90
Gordon Specialties Company.....	98
Gross Radio, Inc.....	79
Gulf Radio School.....	111
Hallcrafters, Inc., The.....	1, 2
Hammarlund Manufacturing Company.....	4, 112
Harvey Radio Company.....	112
Harvey Radio Laboratories, Inc.....	57
Hatry & Young.....	116
Heintz & Kaufman, Ltd.....	83
Henry Radio Shop.....	115
Hipower Crystal Company.....	111
Instructograph Company.....	122
International Resistance Company.....	75
Isolantite, Inc.....	63
J-M-P Manufacturing Company.....	115
Johnson Company, E. F.....	111
Kato Engineering Company.....	99
Kenyon Transformer Company.....	99
Leads.....	66
Logan Company, Les.....	99
M & H Sporting Goods Company.....	113
Mallory & Company, Inc., P. R.....	56, 76
Massachusetts Radio School.....	102
McElroy, T. R.....	111
McGraw-Hill Book Company.....	70
Meissner Manufacturing Company.....	111
Midland Television, Inc.....	72
Mims Radio Company.....	122
Monitor Piezo Products Company.....	107
National Carbon Company.....	86
National Company, Inc.....	Cov. 3, 55, 102, 107, 115
Newark Electric Company.....	60, 61
New York Y. M. C. A. Schools.....	106
Ohmite Manufacturing Company.....	78
Petersen Radio Company.....	96
Port Arthur College.....	119
Precision Apparatus.....	118
Precision Piezo Service.....	114
RCA Institutes, Inc.....	99
RCA Manufacturing Company.....	Cov. 4
Radio Digest.....	91
Radio Mfg. Engineers, Inc.....	77
Radio Shack, The.....	109
Radio Supply Company.....	109
Radio Transceiver Laboratories.....	106
Ramsey Publishing Company.....	115
Raytheon Production Corporation.....	88
Scientific Radio Service.....	107
Shure Brothers.....	110
Signal Electric Mfg. Company.....	118
Simpson Electric Company.....	119
Speer Carbon Company.....	80
Standard Transformer Corporation.....	89, 95
Sun Radio Company.....	108
Taylor Tubes, Inc.....	93
Teleplex Company.....	96
Terminal Radio Corporation.....	117
Thordarson Elec. Manufacturing Co.....	85
Transmitter Equipment Mfg. Company.....	82
Triplett Electrical Instrument Co.....	62
Turner Company.....	118
United Electronics Company.....	68
United Transformer Company.....	128
Utah Radio Products Corporation.....	74
Valpey Crystals, The.....	118
Vibroplex Company.....	106
Wilson, Willard S.....	124
Wincharger Corporation.....	122
Yaxley.....	56, 76



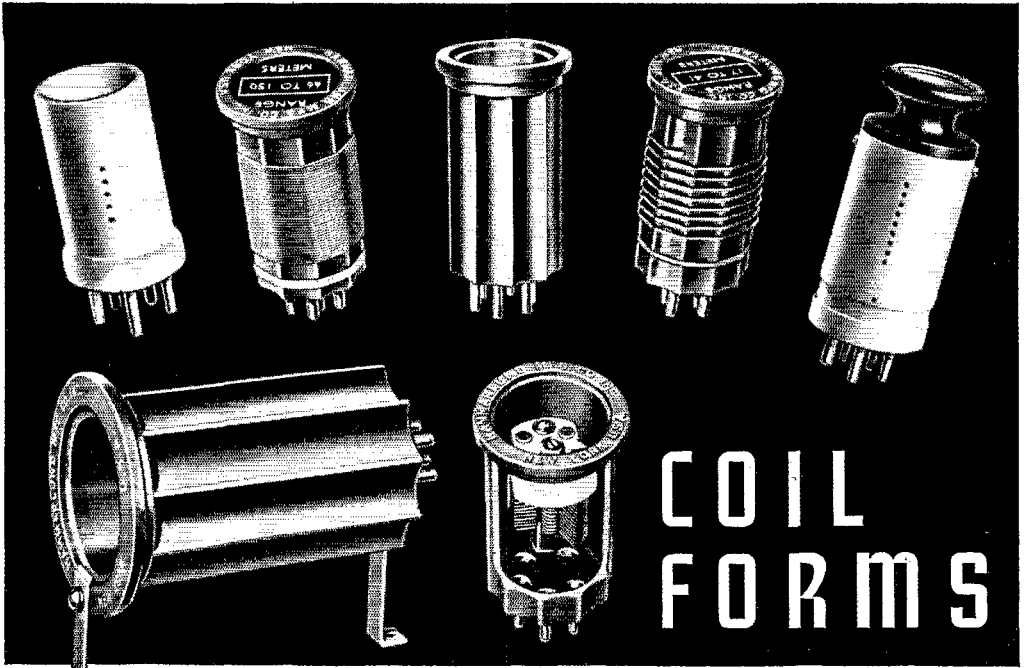

# COIL FORMS

... *for* EVERY PURPOSE

IN THE laboratory or home workshop — wherever precision receivers, transmitters, and miscellaneous devices are being developed or built for ultra-short waves, short waves, or the broadcast band — HAMMARLUND coil forms are always the choice! Such is the unanimous approval because in HAMMARLUND coil forms will be found the advanced design, craftsmanship and finest materials that afford the required outstanding efficiency! For instance, the popular priced "SWF" moulded forms are of "XP-53" dielectric — the remarkable new low loss insulating material that is so rugged, durable and has such an unusually low power factor. The forms are natural in color with no artificial coloring to cause losses. They are also groove ribbed for air spaced windings and have flange grips for easy handling. Meter indexes are also supplied for wave length inscriptions. A special threaded shelf, moulded inside, permits the mounting of an "APC" air condenser for fixed tuning or band spread. Made with four, five, or six prongs.

For transmitting, a jumbo "XP-53" coil form is available. Completely wound "XP-53" coils are made, too, to cover from 10 to 560 meters.

Ceramic "CF" forms of extruded Isolantite for efficient high frequency reception

under all conditions are also made by HAMMARLUND. These have a recessed black enameled wooden handle with removable paper disc, a non-skid surface, and numerous holes for winding. Available in four, five and six prong types. For ultra-high frequencies, HAMMARLUND has developed special "CF-M" Isolantite coil forms 1 1/8" in diameter, with non-skid surface and plenty of mounting holes.

Get the "tops" in results by using HAMMARLUND coil forms! Send for new "37" catalog with further details.

**MAIL COUPON BELOW!**

HAMMARLUND MFG. CO., INC.  
424-438 W. 33rd St., N. Y. City

Please send "37" catalog.

Name .....

Address .....

City.....State.....Q-10



# HAMMARLUND

Say You Saw It in QST — It Identifies You and Helps QST

# Choice of the Discriminating User \*

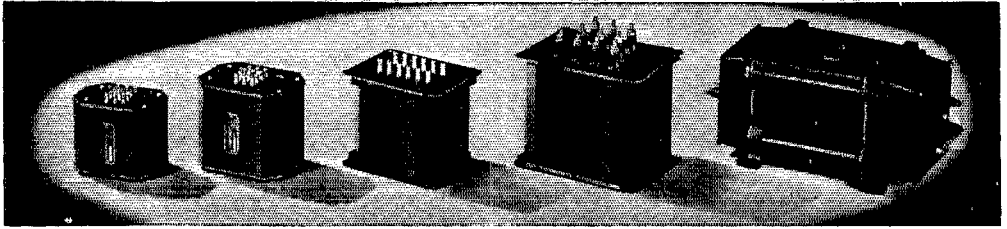

## UTC VARIMATCH TRANSFORMERS

The UTC VARIMATCH transformers consist of a series of driver and output units for every transmitting and P.A. application. Through a unique coil arrangement a very wide range of impedances is obtainable. Obsolescence is practically eliminated with these units, inasmuch as any one unit will match any tubes within its power range.

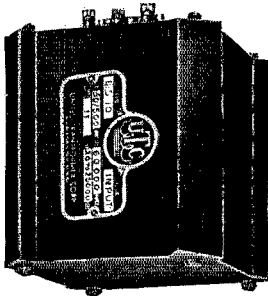

### LINEAR STANDARD COMPONENTS

UTC Linear Standard components are ideal high fidelity units for broadcast, recording, and other applications where highest fidelity is desired. The frequency response is guaranteed uniform from 30 to 20,000 cycles, and the shielding and insertion loss is maintained at extremely low values. These units are unequalled for studio and speech input equipment, home radio, and high fidelity phone transmitters.

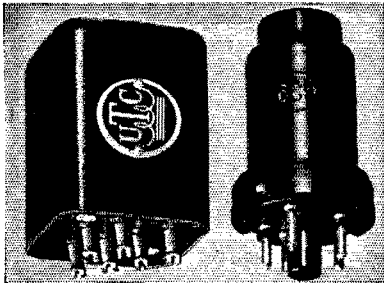

### ULTRA COMPACT HIGH FIDELITY AUDIO UNITS

The UTC ultra compact audio units are extremely small and weigh only 5½ ounces. The fidelity, however, is excellent, the frequency response being uniform  $\pm 2$  DB from 30 to 20,000 cycles. These units are ideal for mobile equipment and similar applications where both weight and size are paramount factors.

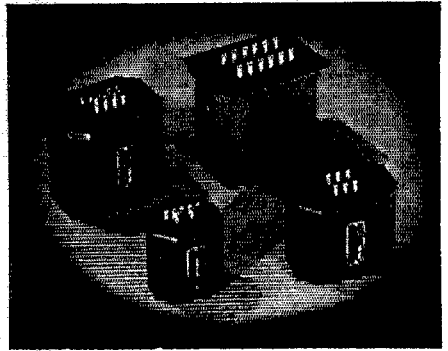

### PUBLIC ADDRESS UNITS

The Public Address series of units is a popular priced line having medium fidelity. A complete line of input, output and power components is provided, suitable for every public address and amateur transmitting function. Units of this class are used extensively by commercial communications companies for service where broadcast fidelity is not essential.

### HIPERM ALLOY COMPONENTS

UTC Hiperm Alloy Components are similar to the Linear Standard units but of a more compact design and employ a light-weight high conductivity case so that these units can be employed for portable and compact service. They are used extensively in recording and remote pickup equipment.

Description of the full line of UTC Transformers is given in the new PS-402 bulletin now available at your jobber

\* UTC Transformers are used by R.C.A., G.E., Western Electric, Westinghouse, Bendix, C.B.S., N.B.C., M.B.S., U. S. Army, Navy, Signal Corps, Coast Guard, Dept. of Commerce, Bureau of Standards, etc.

# UNITED TRANSFORMER CORP.

72 SPRING STREET

NEW YORK, N. Y.

EXPORT DIVISION 100 VARICK STREET NEW YORK, N. Y. CABLES: "ARLAB"

**A NEW RECEIVER THAT HAS EVERY FEATURE**

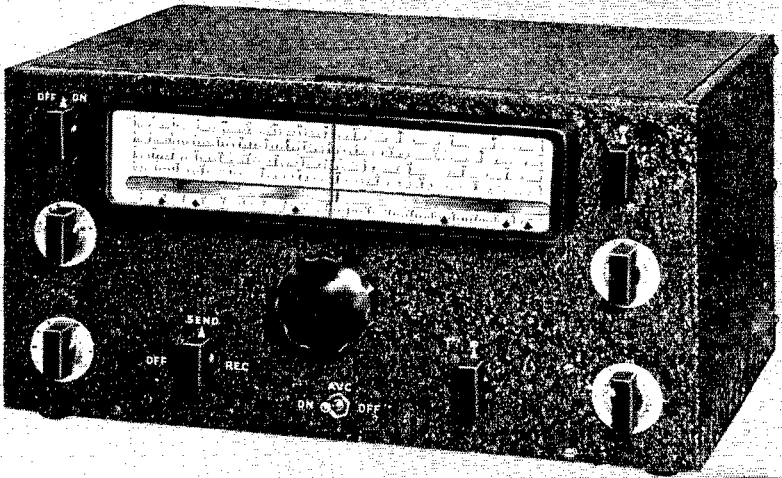

**NET  
\$88.00**  
Complete with  
Tubes and  
Speaker

**AIR-TUNED RF & IF**

**MOVABLE COILS**

The new National NC-80 Receiver employs the same type of movable coil tuning unit used so successfully in the NC-100, and which combines high electrical efficiency with plug-in coil convenience. Every detail of the simplified NC-80 chassis is designed for consistently high performance.

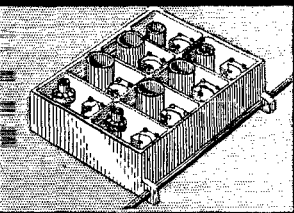

**IMAGE REJECTION**

**CRYSTAL FILTER**

Due to the use of a high IF frequency (1560 KC) image frequencies are so far apart that they can be effectively rejected without a preselector. The greatly improved crystal filter has a selectivity continuously variable from 300 cycles to 7 kilocycles, and is always left in circuit.

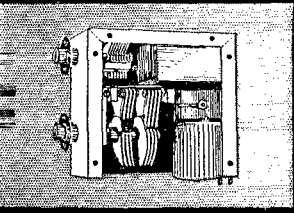

**LOGGING MARKERS**

**IMPROVED DIAL**

The linear scale of the NC-80 Receiver is calibrated directly in megacycles for all coil ranges. A knife-edge pointer and mirror scale enable accurate readings to be made, free from parallax. Convenient, sliding markers make it easy to log stations or band limits directly on the dial itself.

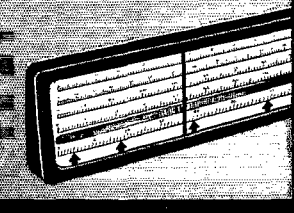

**AMATEUR-BAND-SPREAD**

**DUAL-RATIO TUNING**

The tuning system on the NC-80 has an automatic dual-range control. When running rapidly through the tuning range, the ratio is sixteen-to-one; when tuning in a particular station the ratio automatically shifts to eighty to one. On the special NC-81X amateur model, five coil ranges are provided, each covering one amateur band.

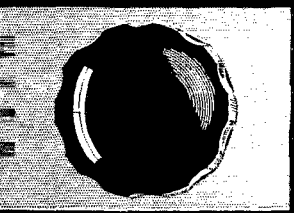

**NATIONAL COMPANY, INC.**

**AC-DC OPERATION**

# Once Again-RCA SCORES WITH NEW LOW PRICES FOR AMATEUR TUBES

**I**N MARCH we announced that our engineering, manufacturing, and sales efforts on amateur tubes would be concentrated on a few outstanding types. Increased volume on these types now permits us to make substantial money-saving reductions. Never before have quality tubes cost so little—and at a time when prices generally are being increased.

## RCA-802

The favorite for crystal and buffer stages. Easy to drive. No neutralization. This popular type now sells for **\$3.50**



## RCA-805

This husky favorite—125 watts max. plate dissipation, 1500 max. plate volts, 210 max. plate ma.—It's in the price class of tubes having considerably less capabilities, now sells for **\$13.50**



## RCA-806

This heavy-duty, tantalum-plate triode, a popular tube, at a new low price. Now only **\$22**



## RCA-807

With new improvements the RCA-807 is an even greater value today. Tremendous acceptance makes possible the new price **\$3.50**



## RCA-808

Here's a real buy! High-mu, low interelectrode capacities, 1500 max. plate volts, 150 max. plate ma., rugged construction, heavy-duty filament—all combine to make this tube a sensation at **\$7.75**



## RCA-866

For your power supply, this RCA tube, with its outstanding quality and reliability is now yours for only **\$1.50**



## RCA-906

The first popular 3" cathode-ray tube was originally \$18.00, but because of steadily increasing demand, now sells for **\$13.50**

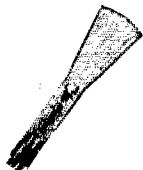

## RCA-913

Sensational when introduced at \$5.60 less than a year ago, this tube because of tremendous acceptance, can now be sold at **\$4.00**



With all the advantages of RCA quality, design features, reliability and performance capabilities costing so little today — why not do as the winners in the DX Contest did — go RCA Tubes All the Way in your transmitter and receiver?



# for Amateur Radio

AMATEUR RADIO SECTION

RCA Manufacturing Co., Inc., Camden, N. J. · A Service of the Radio Corporation of America